

# **HYPRO<sup>®</sup> • SHURFLO<sup>®</sup>**

**PUMPS, SPRAY NOZZLES, AND ACCESSORIES  
PRODUCT CATALOG**

---

# Table of Contents

---

<b>Pumps and Engines</b> .....	<b>1-128</b>
Selecting the Right Pump .....	2-10
Centrifugal Pumps .....	11-54
Life Guard Silicon Carbide Pump Seals.....	52
Self-Priming Adaptor (SPA) .....	53
Centrifugal Pump Accessories.....	54
Transfer Pumps .....	55-62
Roller Pumps.....	63-73
Roller Pump Kits & Accessories.....	71-72
Other Pump Accessories .....	73
Diaphragm Pumps.....	74-88
Diaphragm Pump Accessories, Kits and Control Units .....	86-88
Shurflo Pumps .....	89-104
Shurflo Diaphragm Pumps .....	89-99
Shurflo Diaphragm Pump Accessories and Fittings .....	100-101
Shurflo Mini-Bulk Chemical Transfer Systems and Accessories .....	102-104
Piston / Plunger Pumps and Hydraulically-Driven Pressure Washers.....	105-121
Specialty Pumps (Versa-Twin, Noryl, Hydraulic-Driven Gear Pump and Aqua-Tiger).....	122-126
Pump Cutaways .....	127
PowerPro Gasoline Engines.....	128
<b>Spray Nozzles</b> .....	<b>129-214</b>
Selecting the Right Spray Nozzles.....	130-133
Broadcast Spray Nozzles .....	134-165
Steaming Spray Nozzles .....	166-171
Banding and Directed Spray Nozzles.....	172-187
Specialty Spray Nozzles.....	188-200
Caps, Filters and Training Tools.....	201-203
Technical Information – Spray Nozzles.....	204-214
<b>Accessories</b> .....	<b>215-262</b>
ProStop-E and Fence Row Control.....	216-217
Express Boom Assembly.....	218-219
Duo React.....	220
ProFlo Nozzle Bodies, Accessories, Boom Clamps and Foam Marker .....	221-228
ProCap Tank Lids and Tank Accessories (ProClean) .....	229-233
Cleanload Chemical Eductor, Poly or Stainless Steel Eductor.....	234-235
Line Strainers.....	236-237
Spray Guns & Lances .....	238-242
Flowmeters.....	243
Sprayer Control Valves .....	244-247
Ball Valves .....	248-249
Gauges .....	249-251
Universal Flange Clamps, Gaskets and Fittings.....	252-253
Fittings, Cable Ties, Hose Clamps and Sealant.....	254-264
<b>Index</b> .....	<b>265-280</b>
<b>Limited Warranty on Hypro/SHURflo Pumps and Other Hypro Products</b> .....	<b>281</b>

# Pumps and Engines

---

## Centrifugal Pumps..... Page 11

- Commonly used with self-propelled sprayers, large-trailed sprayers, and construction equipment
  - Material Options: Cast Iron, Polypropylene, 316 Stainless Steel
  - Pressure Range: 0-150 psi (0- 10 bar)
  - Flow Range: 0-1078 gpm (0-4080 lpm)

## Transfer Pumps ..... Page 55

- Commonly used with tender trailers and fluid transfer stations
  - Material Options: Polypropylene, Aluminum, Cast Iron
  - Pressure Range: 0-55 psi (0- 3.8 bar)
  - Flow Range: 0-460 gpm (0-1740 lpm)

## Roller Pumps ..... Page 63

- Commonly used with 3-point sprayers, pest control, and de-icing skids
  - Material Options: Cast Iron, Ni-Resist, Silver Series XL
  - Pressure Range: 0-300 psi (0- 20 bar)
  - Flow Range: 0-60 gpm (0-227 lpm)

## Diaphragm Pumps ..... Page 74

- Commonly used with nutrient application systems, fruit & vegetable sprayers, and pressure cleaning system
  - Material Options: Aluminum, Brass, Polypropylene
  - Pressure Range: 0-725 psi (0- 50 bar)
  - Flow Range: 0-66 gpm (0-250 lpm)

## Shurflo Diaphragm Pumps ..... Page 89

- Commonly used with ATV sprayers and nutrient application systems
  - Material Options: Polypropylene, Nylon
  - Pressure Range: 0-150 psi (0- 10 bar)
  - Flow Range: 0-5 gpm (0-19 lpm)

## Piston & Plunger Pumps..... Page 105

- Commonly used with pressure-cleaning and car wash systems
  - Material Options: Cast Iron, 316 Stainless Steel, Brass
  - Pressure Range: 0-3600 psi (0- 248 bar)
  - Flow Range: 0-45 gpm (0-170 lpm)

## Specialty Pumps ..... Page 122

- Versa-Twin: transferring liquids in carpet cleaning, pest control, and turf spraying
- Noryl: bulk transfer of fertilizer and agricultural chemicals
- Aqua-Tiger: general pumping applications where a flooded intake is provided

## PowerPro Engines ..... Page 128

# Selecting the Right Pump

Because the pump is the “heart of the liquid system” on equipment, careful consideration must be made in selecting the right pump. Seldom is there only one pump that will do the job. To make a wise choice, you will need to know about pump types, how the pump is driven, and the flow and pressure requirements for your specific spraying system and application.



## 1. Pump Types

To ensure you can closely match the pump to your needs, Pentair manufactures six different types of pumps under the Hypro and SHUflo brands: centrifugal, transfer, roller, diaphragm, piston and plunger pumps.

### “Positive displacement” vs. “Non-positive displacement”

Pumps can be divided into two general categories: “positive displacement” and “non-positive displacement.”

**Positive Displacement** – In a positive displacement pump the flow from the pump is directly proportional to the pump speed. Liquid is captured and discharged as a fixed volume per revolution of the pump shaft. This positive flow is why all positive displacement pump installations must include a relief valve and bypass line between the pump outlet and the nozzle shut-off valve. Roller, diaphragm, piston and plunger pumps are positive displacement pumps.

**Non-positive Displacement** – In a non-positive displacement pump a rotating impeller creates a centrifugal force that overcomes the restriction of liquid flow through the system. If the outlet is closed, the impeller continues to rotate harmlessly without damaging system components. Centrifugal and transfer pumps are non-positive displacement pumps.

### Centrifugal Pumps -Spray & Transfer Applications (non-positive displacement)

In centrifugal pumps, liquid enters through the center of a rotating impeller that is driven at speeds up to 6000 RPM. Liquid is forced to the outer edge of the housing; this centrifugal force is what delivers the liquid to the nozzle. Traditionally thought of as low to medium pressure pumps, the Hypro line of centrifugal pumps can deliver from 0-150 psi (0-10 bar) and flow rates up to 440 gpm (1760 lpm). Centrifugal pumps have minimum surfaces to wear and no poppet valves, making them very durable, easy to maintain and well suited for pumping abrasive and corrosive materials. Because centrifugal pumps operate at higher speeds than the RPMs of a tractor PTO, the speed must be increased through a gear drive, belt drive, gas engine drive, or high-speed hydraulic motor drive. Pump models are specifically designed for each of these drive applications. The broad, versatile line includes models with rugged housings and components of cast iron, polypropylene, engineered plastics and stainless steel that endure the wide variety of agricultural chemicals.



# Selecting the Right Pump

## Diaphragm Pumps (positive displacement)



Diaphragm pumps are designed to isolate abrasive and corrosive solutions being pumped from its mechanical drive components through the use of synthetic diaphragms.

Diaphragm pumps are compact, self-priming and produce low-to-high pressures 0 to 725 psi (0-50 bar) with flow rates of 3.8 to 65.7 gpm (14.5 -260 lpm). Driven by 540 rpm PTO, gas engine, or hydraulic motor, diaphragm pumps are used for a variety of agricultural, horticultural and pest control spraying applications.

Shurflo pumps are efficient, 12 VDC electric motor driven low pressure diaphragm pumps designed for smaller spray applications with pressures 0-150 psi (0-10 bar) and flows 0-5.3 gpm (0-20 lpm). Shurflo pumps fit uniquely into mobile applications on ATV, home lawn care, fertilizer and pesticide equipment.



## Roller Pumps (positive displacement)



The Hypro line of roller pumps are an economical choice by farmers throughout the world. The rollers revolve inside the pump housing on an eccentric profile to force spray solution through the pump which then develops pressure and flow. The roller pump offers a compact design with

mechanical simplicity to provide a low initial cost pump that is extremely versatile. They operate efficiently at PTO speeds of 540 and 1000 rpm and have a wide pressure range of up to 300 psi (20 bar) and flow rates of 2 to 62 gpm (7 to 235 lpm). Roller pumps are self-priming and easily adapt to PTO or gas engine drives. Specific seal, roller and casting materials can be selected for compatibility with certain herbicides, pesticides, fungicides and fertilizers.



## Piston and Plunger Pumps (positive displacement)



Piston/Plunger pumps have a shaft, pistons or plungers and "inlet" and "outlet" poppet valves. The design of the pump converts the rotational drive into a oscillating vertical motion. On the down-stroke, the inlet valve opens, filling the chamber with solution. On the up-stroke, the outlet valve opens, and the piston forces the solution to the nozzle. Piston pumps deliver relatively low flow rate, less than 10 gpm (40 lpm), at pressures up to 1000 psi (69 bar). Plunger pumps are designed with ceramic plungers which can operate at higher pressures up to 3600 psi (248 bar) at flows up to 45 gpm (170 lpm). The main difference of construction is in a piston pump the sealing material moves with the piston while in a plunger pump the sealing material (u-cups) are stationary with only

the plunger in motion. The replaceable piston cups can be of leather, fabric or Buna-N rubber, depending on the type of solution to be sprayed. They can be driven by 540 rpm PTO, gas engine, hydraulic or electric motor. Their low volume/ high pressure capability permits use in general spraying as well as task-oriented applications such as spraying fence rows and ditches, and hydrostatic testing. Plunger pumps are used primarily for cleaning operations.

# Selecting the Right Pump

---

## 2. Pump Drives

How a pump is to be driven is often a primary consideration in selecting the proper type of pump. If the power source has already been determined, the following chart may be of further help in selecting the type of pump that is best suited to your needs.

### How do you plan to drive the pump?

If your power source is:		Roller	Centrifugal and Transfer	Diaphragm	Piston/Plunger
<b>540 rpm PTO</b>	direct coupled:	X		X	X
	through gear drive:		X		
	through belt/pulley:		X		
<b>1000 rpm PTO</b>	direct coupled:	X			
	through gear drive:		X		
	through belt/pulley:		X		
<b>Hydraulic Motor</b>		X	X	X	X
<b>12 Volt DC Motor</b>		X		X	X
<b>Gas Engine</b>	direct coupled:	X	X		
	through gear reduction:	X		X	X
	through belt/pulley:	X	X	X	X
<b>Electric Motor</b>	direct coupled:	X	X		
	through belt/pulley:	X	X	X	X

# Selecting the Right Pump

## 3. Flow and Pressure Requirements

Pump pressure required is often dependent on the application. Whether it be low pressure band spraying or high pressure tree spraying, it is the application that dictates what pressure is needed to get the right performance at the spray nozzle. Once you know what pressure is desired choose a pump with extra pressure capacity due to losses in pressure as it goes through the system components (strainer, valves, elbows, hose, etc.) out to the nozzle.

### How Much Pressure Do You Need?

Pressure		Flow		Pump
0-150 psi (0-10 bar)		0-1078 gpm (0-4080 lpm)		Centrifugal
0-150 psi (0-10 bar)		0-5 gpm (0-20 lpm)		Shurflo Diaphragm
0-300 psi (0-20 bar)		0-60 gpm (0-225 lpm)		Roller
0-725 psi (0-50 bar)		0-60 gpm (0-225 lpm)		HYPRO Diaphragm
0-1000 psi (0-69 bar)		0-10 gpm (0-38 lpm)		Piston/Plunger
0-3600 psi (0-248 bar)		0-45 gpm (0-170 lpm)		Plunger

Pump flow required is dependent on several factors. Application rate, width of boom or size of nozzle, speed of travel and agitation. To review your pump flow requirements follow through the calculations presented on the following pages. As with pressure you will want to choose a pump that has additional flow so that it meets your application needs over time as performance drops due to component wear.

### How Much Flow Do You Need?

Flow		Pressure		Pump
0-5 gpm (0-20 lpm)		0-150 psi (0-10 bar)		Shurflo Diaphragm
0-10 gpm (0-38 lpm)		0-1000 psi (0-70 bar)		Piston/Plunger
0-45 gpm (0-170 lpm)		0-3600+ psi (248+ bar)		Plunger
0-60 gpm (0-225 lpm)		0-300 psi (0-20 bar)		Roller
0-60 gpm (0-225 lpm)		0-725 psi (0-50 bar)		HYPRO Diaphragm
0-1078 gpm (0-4080 lpm)		0-150 psi (0-10 bar)		Centrifugal

# Selecting the Right Pump

---

## Determining Pump Flow and Pressure Requirements

Every pumping task has an optimum volume and pressure requirement. Determining that optimum (and selecting the pump that delivers it) is key to an efficient and economical spraying system operation.

Pressure requirements for agricultural pumps are dependent on both the material to be applied and application targets. Soil-applied herbicides generally require a relatively low pressure pump rating of 30-60 psi with foliar-applied herbicides at the top end of that range and slightly higher. Insecticides and fungicides can require higher pressure ratings of 100 to 500 psi. Pressure must be sufficient, in the case of heavy foliage field crops and orchard crops, to penetrate the leaf foliage. In the case of orchard crops, pressure must also be sufficient to carry material up and over as well as into the canopy.

A number of factors must be considered to properly determine the total flow you will need from your pump. They include:

- Type of spray operation (broadcast, banding, low-level, etc.)
- The chemical's application rate, ground speed, boom width, hose length, tank agitation, etc.

The spray task is the first consideration in determining flow rate and pressure needs. The following formulas and calculations may help.

## Calculating Agitation Requirements

The pump must produce enough flow for both the application rate and tank agitation requirements. Too little agitation will not keep the solution in proper suspension and too much agitation may cause foaming. Here are rule of thumb formulas for calculating how much additional pump flow you will need for agitation.

Liquids:

$$\text{Tank volume (gallons)} \times .05 = \text{total agitation in gpm} \quad \text{or} \quad \text{Tank volume (litres)} \times .05 = \text{total agitation in lpm}$$

Wetable Powders and Flowables:

$$\text{Tank volume (gallons)} \times .125 = \text{total agitation in gpm} \quad \text{or} \quad \text{Tank volume (litres)} \times .125 = \text{total agitation in lpm}$$

EXAMPLE: If you will be spraying a wettable powder from a 100-gallon tank, proper agitation will require 12.5 gpm additional flow from the pump.

## Reducing Agitation Flow Requirements

Agitation flow requirements can be reduced by using jet agitation in the tank. Jet agitators use a venturi design to multiply agitation output. Depending on the jet agitator model and pressure, one gallon per minute input can provide two to ten gallons per minute agitation output. If your sprayer is equipped with a jet agitator, consult the operator's manual or documentation to find the output to input ratio and adjust your flow required for agitation accordingly.

Agitation Flow with Jet Agitation:

$$\text{required gpm} \times \frac{\text{input}}{\text{output}} \quad \text{or} \quad \text{required lpm} \times \frac{\text{input}}{\text{output}}$$

For example: If you calculate a requirement of 63 gpm of agitation and your jet agitator produces 3 to 1 output to input ratio, your pump would only need 1/3 of 63 gpm, or 21 gpm.



# Selecting the Right Pump

## Factor in an “Excess Flow” Requirement

It is wise to have some excess flow capacity so you will not end up with an undersized pump because actual operation conditions may cause changes in spray system performance (such as normal pump wear, operating at less than rated speeds, etc.). Hypro recommends you add an additional 20% to your calculated total pump flow requirement to compensate for these variables. Plumbing systems have a number of restrictions that will result in a pressure drop from the pump to the actual spray point. These must be taken into account and minimized.

## Calculating Pump Flow for Broadcast Boom Sprayers

Chemical application is measured in gallons per acre (gpa) or litres per hectare (l/ha), whereas pump flow is stated in gallons per minute (gpm) or litres per minute (lpm). To calculate the pump flow required by a broadcast boom sprayer, multiply the application rate (from the chemical label) by the sprayer ground speed. Multiply the sum by the boom width on your sprayer. Then, divide that number by 495 for US units or by 600 for metric units. As a formula, it is written like this:

Flow required for boom:

$$\text{gpm} = \frac{\text{gpa} \times \text{mph} \times \text{boom width (ft.)}}{495}$$

or

$$\text{lpm} = \frac{\text{l/ha} \times \text{km/hr} \times \text{boom width (m)}}{600}$$

The result will be the pump flow required to deliver the proper application rate at the boom’s nozzles. Then calculate your total pump flow requirement (broadcast):

Flow required for boom:	_____	gpm	
Flow required for agitation:	+ _____	gpm	
Sub-total	= _____	gpm	
Excess flow requirement:	x <u>1.20</u>		
<b>TOTAL PUMP FLOW NEEDED:</b>	<b>= _____</b>	<b>gpm</b>	

or

Flow required for boom:	_____	lpm	
Flow required for agitation:	+ _____	lpm	
Sub-total	= _____	lpm	
Excess flow requirement:	x <u>1.20</u>		
<b>TOTAL PUMP FLOW NEEDED:</b>	<b>= _____</b>	<b>lpm</b>	

## Calculating Pump Flow for Banding Sprayers

First, multiply the band width by the number of rows to determine the total width (w). Then, multiply the application rate (from the chemical label) by the ground speed. Multiply that result by the total width (w) calculated earlier, then divide the result by 5940 for US units or 60,000 for metric units. Here’s how the formula appears:

Total band width of sprayer:

$$w = \text{rows} \times \text{band width (inches)}$$

or

$$w = \text{rows} \times \text{band width (cm)}$$

Flow required for banding nozzles:

$$\text{gpm} = \frac{\text{gpa} \times \text{mph} \times w}{5940}$$

or

$$\text{lpm} = \frac{\text{l/ha} \times \text{km/hr} \times w}{60,000}$$

The result will be the pump flow required to deliver the proper application rate at the boom’s nozzles. Then calculate your total pump flow requirement (banding):

Flow required for boom:	_____	gpm	
Flow required for agitation:	+ _____	gpm	
Sub-total	= _____	gpm	
Excess flow requirement:	x <u>1.20</u>		
<b>TOTAL PUMP FLOW NEEDED:</b>	<b>= _____</b>	<b>gpm</b>	

or

Flow required for boom:	_____	lpm	
Flow required for agitation:	+ _____	lpm	
Sub-total	= _____	lpm	
Excess flow requirement:	x <u>1.20</u>		
<b>TOTAL PUMP FLOW NEEDED:</b>	<b>= _____</b>	<b>lpm</b>	

# Selecting the Right Pump

## Calculating Pump Flow for Hand Gun Spraying

For low-level spraying with a hand gun, such as for lawn and turf care, professional applicators typically “walk” the lawn at about 1,000 sq. ft. per minute or 100 sq. m per minute. That means the “gpm” or “lpm” rate of the hand gun will generally be the same as “gallons per 1,000 sq. ft.” or “litres per 100 sq. m.”

### To Determine Your Total Pump Flow Requirement:

Flow required for gun/nozzle:	_____ Litres per 1,000ft <sup>2</sup> (same as gpm)	Flow required for gun/nozzle:	_____ Litres per 1,000ft <sup>2</sup> (same as gpm)
Flow required for agitation:	+ _____ gpm	Flow required for agitation:	+ _____ lpm
Sub-total	= _____ gpm	Sub-total	= _____ lpm
Excess flow requirement:	x <u>1.20</u>	Excess flow requirement:	x <u>1.20</u>
<b>TOTAL PUMP FLOW NEEDED:</b>	= _____ gpm	<b>TOTAL PUMP FLOW NEEDED:</b>	= _____ lpm

Use this same method for calculating the pump flow requirement for high pressure spraying, such as trees. Even though the application “rate” is usually a visual saturation of the tree, the known gpm or lpm factor will be the hand gun nozzle output, which is the rate you use for the calculation.

## Calculating Pump Pressure for Hand Gun Spraying

For most hand gun chemical spraying, 40 psi (3 bar) at the nozzle is typical. To properly select a pump that can deliver the right nozzle pressure, you must consider the normal “pressure drop” that occurs within the length of hose. The amount of pressure drop through the hose depends on hose length, hose diameter and flow rate. For example, 300’ (90 m) of 1/2” hose spraying at 6 gpm (23 lpm), will have a pressure drop of approximately 120 psi (8 bar). That means you need a pump delivering at least 160 psi (12 bar) in order to ensure 40 psi (3 bar) at the nozzle.

Desired pressure at gun nozzle:	_____ psi	Desired pressure at gun nozzle:	_____ bar
Hose pressure loss:	+ _____ psi	Hose pressure loss:	+ _____ bar
<b>TOTAL PUMP PRESSURE NEEDED:</b>	= _____ psi	<b>TOTAL PUMP PRESSURE NEEDED:</b>	= _____ bar

NOTE: When determining the total pump pressure requirement for high tree spraying, you must also consider the spray height (or reach) you need to attain. Generally, pumps of up to 700 psi (50 bar) are used for this purpose.

### Pressure Loss at Various Rates of Flow of Water Through Hose\*

at temperature of 68° Fahrenheit (20°C.)

\*1/4-inch to 1-inch inside diameter

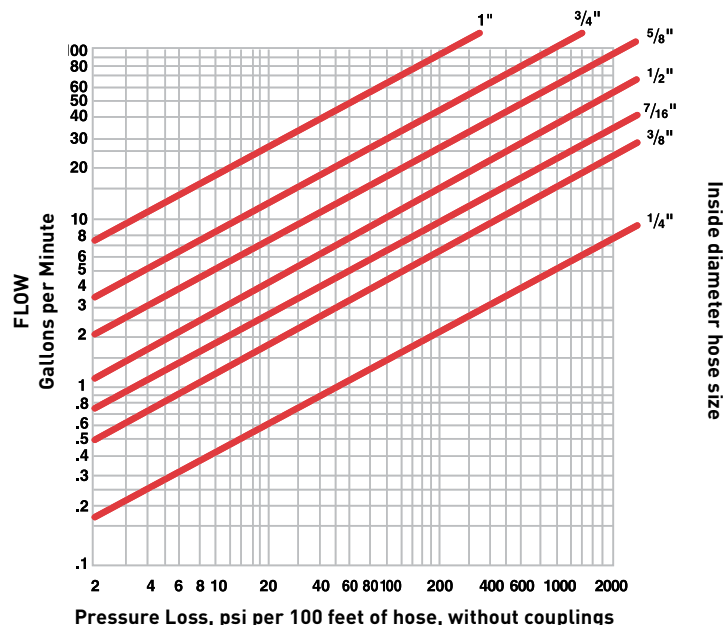

# System Hook-Ups

## Centrifugal Pumps

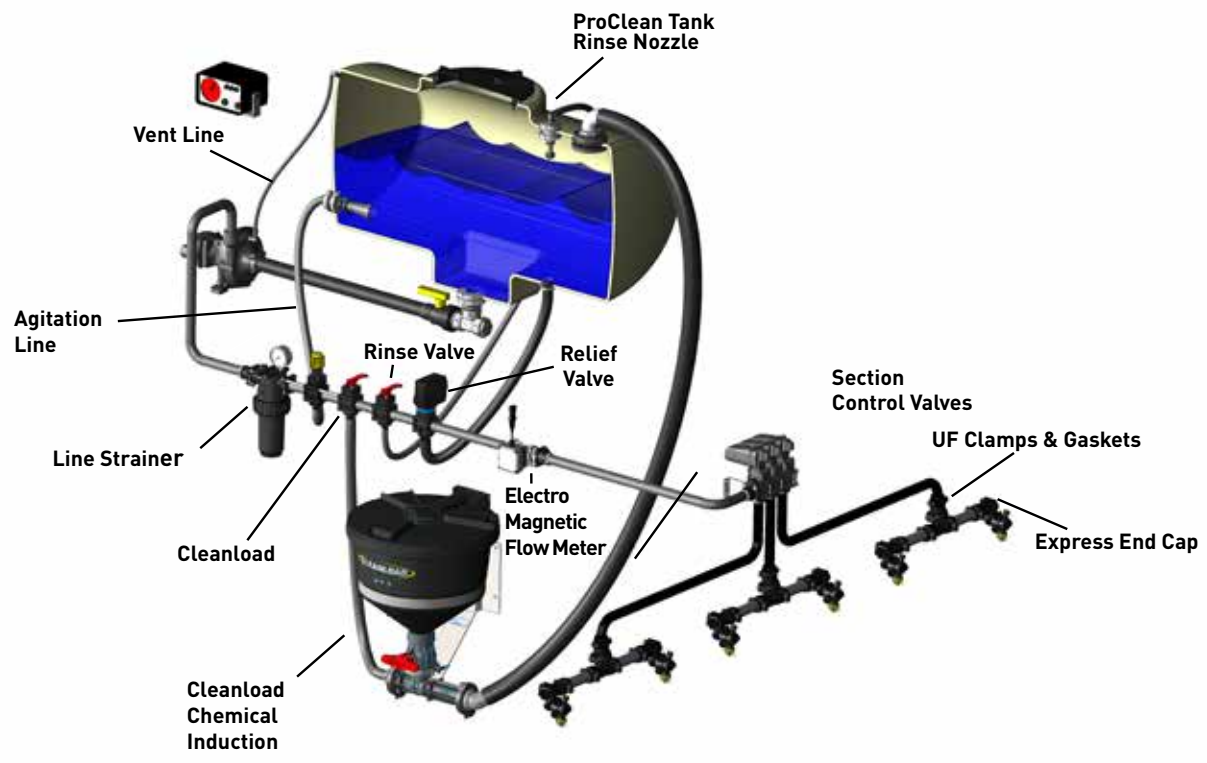

# System Hook-Ups

## Roller, Diaphragm Pumps

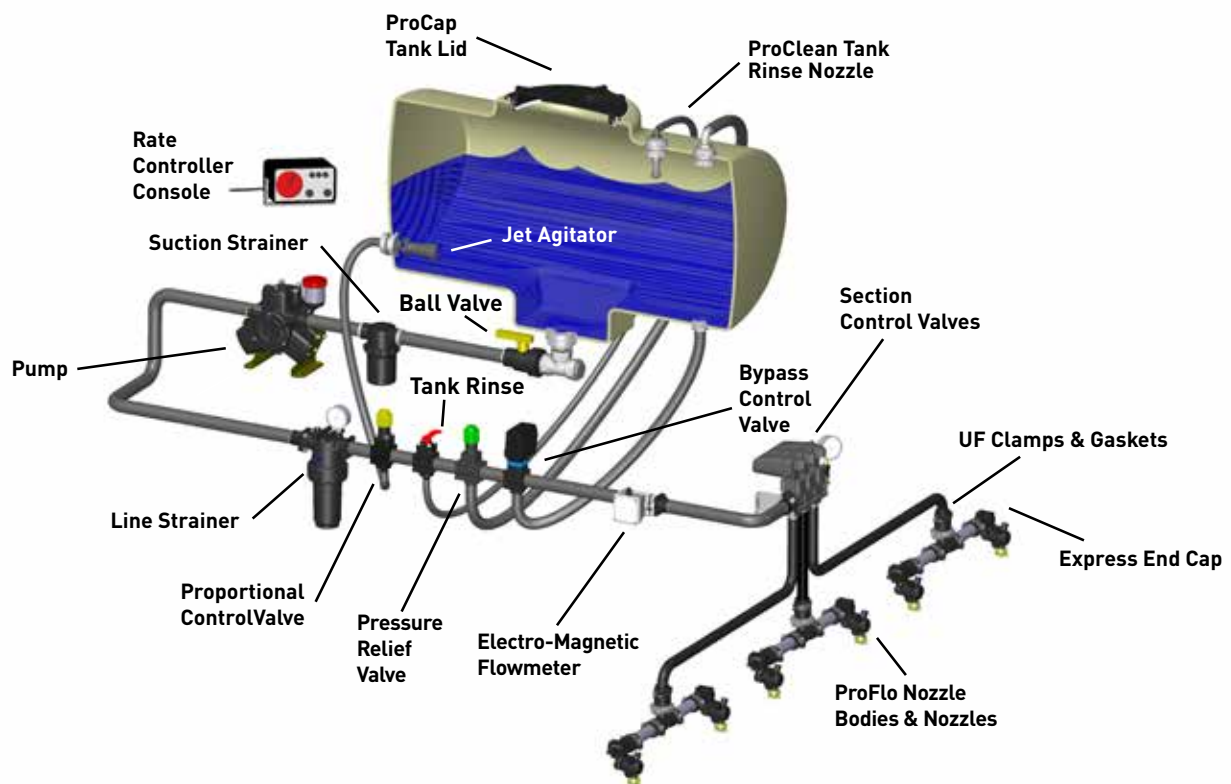

Hypro carries all parts labeled above. Please contact your local Hypro dealer by using the "Where to Buy" function on our website at [www.hypropumps.com](http://www.hypropumps.com), or call 1-800-424-9776 for more information.

# System Hook-Ups

## Diaphragm Pumps, High Pressure Applications

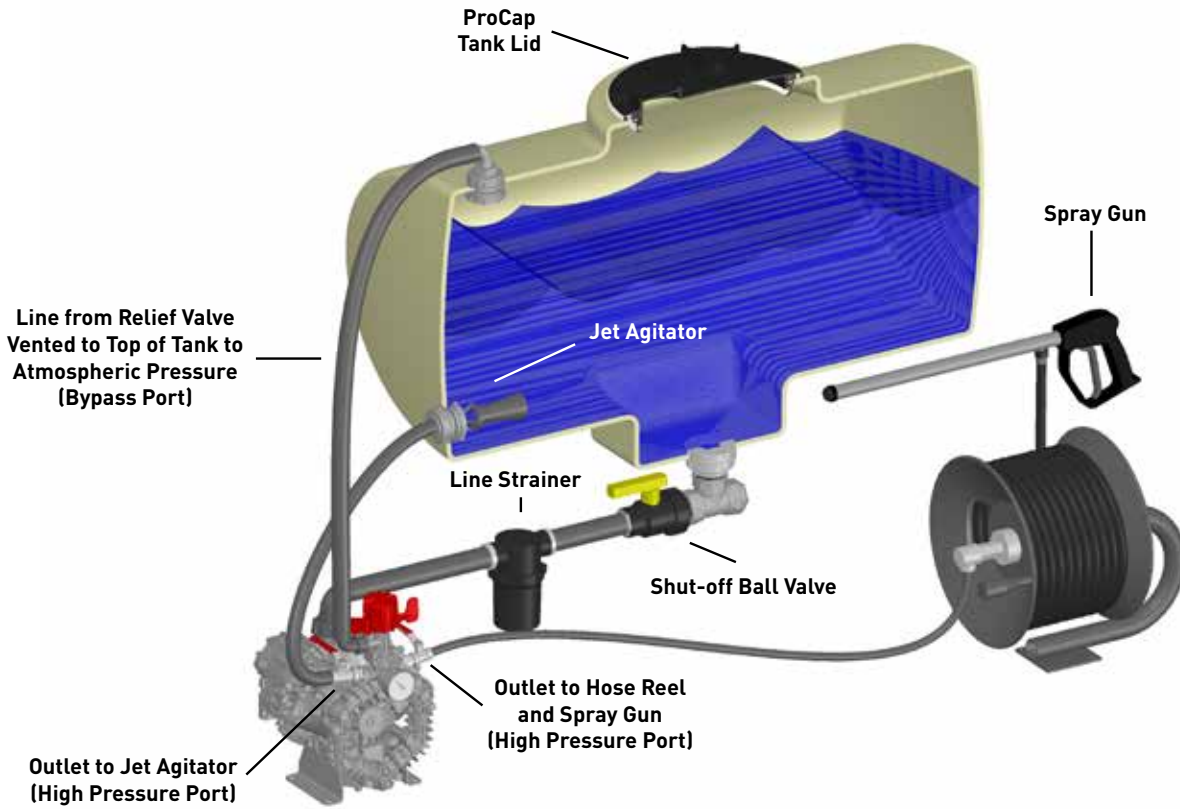

# System Hook-Ups

## Small Twin® Piston Pumps

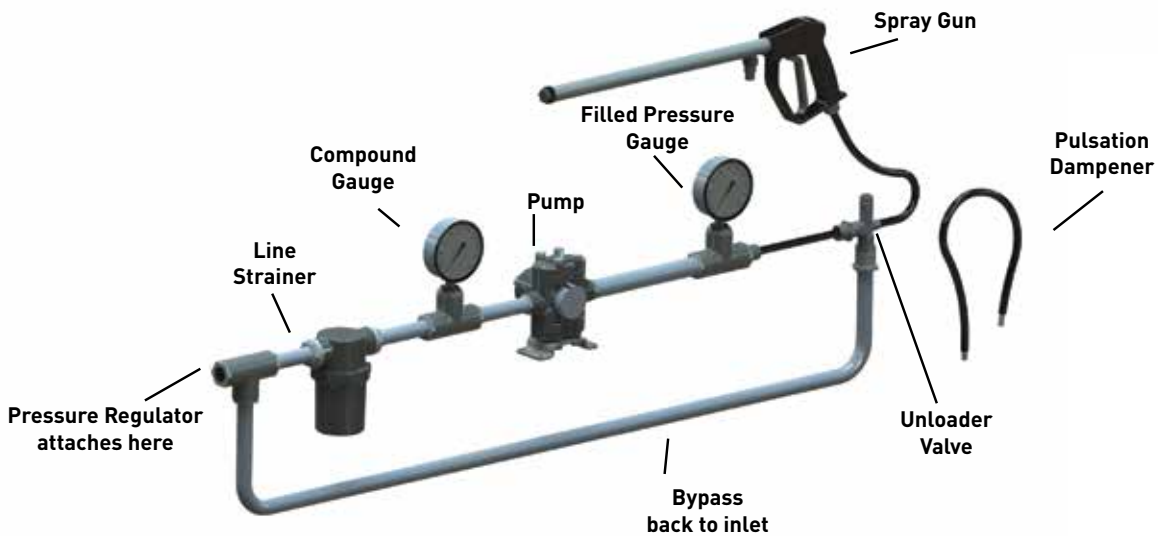

Hypro carries all parts labeled above. Please contact your local Hypro dealer by using the "Where to Buy" function on our website at [www.hypropumps.com](http://www.hypropumps.com), or call 1-800-424-9776 for more information.

# Gear Driven, Cast Iron

## Series 9000C-0



### Upgrade Options:

- Increase dry-run and abrasive resistance with Life Guard Seals
  - Life Guard seals are the OEM standard

### Features

- Planetary oil-bath gear drive
- Port sizes: 1-1/2" NPT inlet, 1-1/4" NPT outlet
- Max. fluid temperature: 140°F/60°C
- Housing: Cast iron
- Impeller: Nylon
- Pump shaft rotation: Counter clockwise when looking at the shaft end
- Pump seals: Viton®/ceramic standard; Life Guard silicon carbide (B) available
- Life Guard seals are the industry standard on OEM equipment
- Weight: 44 lbs./20 kg

### Order Information

Model Number	Max GPM	Max LPM	Max PSI	Max BAR	Max RPM	PTO Output	Locking Collar and Mounting Clip
9006C-0	117	443	78	5.4	600	1-3/8" 6 spline (SAE) 540 rpm female	x
9008C-0	110	416	75	5.2	1000	1-3/8" 21 spline (SAE) 1000 rpm female	x
9016C-0	117	443	78	5.4	600	1" (25.4 mm) Solid Shaft	
9018C-0	110	416	75	5.2	1000	1" (25.4 mm) Solid Shaft	
9028C-0	110	416	75	5.2	1000	1-3/4" 20 spline (SAE) 1000 rpm female	x
90029	110	416	75	5.2	1000	38mm 8 spline 1000 rpm female	x
3430-0334	Seal and o-ring repair kit						
3430-0591	Life Guard silicon carbide seal kit						

Life Guard silicon carbide seal - Add suffix "B" (i.e.: 9006C-0-B)

### 9006C-0, 9016C-0

### U.S. Units

RPM	GPM at 20 PSI	GPM at 30 PSI	GPM at 40 PSI	GPM at 50 PSI	GPM at 60 PSI	GPM at 70 PSI
500	97	86	71	47		
540	106	96	87	70	47	
600	117	113	104	96	82	63

### 9008C-0, 9018C-0, 9028C-0, 90029

### U.S. Units

RPM	GPM at 20 PSI	GPM at 30 PSI	GPM at 40 PSI	GPM at 50 PSI	GPM at 60 PSI	GPM at 70 PSI
800	82	70	53			
900	96	88	76	60	24	
1000	110	102	96	86	70	46

### 9006C-0, 9016C-0

### Metric Units

RPM	LPM at 1.4 BAR	LPM at 2.1 BAR	LPM at 2.8 BAR	LPM at 3.4 BAR	LPM at 4.1 BAR	LPM at 4.8 BAR
500	367	326	269	178		
540	401	363	329	265	178	
600	443	428	394	363	310	238

### 9008C-0, 9018C-0, 9028C-0, 90029

### Metric Units

RPM	LPM at 1.4 BAR	LPM at 2.1 BAR	LPM at 2.8 BAR	LPM at 3.4 BAR	LPM at 4.1 BAR	LPM at 4.8 BAR
800	310	265	201			
900	363	333	288	227	91	
1000	416	386	363	326	265	174

Viton® is a registered trademark of DuPont. Hypro® is a registered trademark of Pentair.

# Gear Driven, Cast Iron, Self-Priming

## Series 9000C-O-SP



### Upgrade Options:

- Increase dry-run and abrasive resistance with Life Guard Seals
  - Life Guard seals are the OEM standard

### Features

- Planetary oil-bath gear drive
- Port sizes: 1-1/2" NPT inlet, 1-1/4" NPT outlet
- Max. fluid temperature: 140°F/60°C
- Housing: Cast iron
- Impeller: Nylon
- Pump shaft rotation: Counter clockwise when looking at the shaft end
- Pump seals: Viton®/ceramic standard; Life Guard silicon carbide (B) available
- Life Guard seals are the industry standard on OEM equipment
- Weight: 62 lbs./28.2 kg

### Order Information

Model Number	Max GPM	Max LPM	Max PSI	Max BAR	Max RPM	PTO Output	Locking Collar and Mounting Clip
9006C-O-SP	119	450	77	5.3	600	1-3/8" 6 spline (SAE) 540 rpm	x
9016C-O-SP	119	450	77	5.3	600	1" (25.4 mm) solid shaft	
9028C-O-SP	117	443	69	4.35	1000	1-3/4" 20 spline (SAE) 1000 rpm	x
3430-0334	Seal and o-ring repair kit						
3430-0591	Life Guard silicon carbide seal kit						
3430-0480SP	Self priming chamber kit						

Life Guard silicon carbide seat - Available upon request

### 9006C-O-SP, 9016C-O-SP

#### U.S. Units

RPM	GPM at 10 PSI	GPM at 20 PSI	GPM at 30 PSI	GPM at 40 PSI	GPM at 50 PSI	GPM at 60 PSI	GPM at 70 PSI
500	101	95	77	51	12		
540	111	109	94	74	47	11	
600	119	118	112	97	79	54	23

### 9028C-O-SP

#### U.S. Units

RPM	GPM at 10 PSI	GPM at 20 PSI	GPM at 30 PSI	GPM at 40 PSI	GPM at 50 PSI	GPM at 60 PSI
800	91	81	57	19		
940	105	101	84	60	25	
1000	117	114	104	87	65	33

### 9006C-O-SP, 9016C-O-SP

#### Metric Units

RPM	LPM at 0.7 BAR	LPM at 1.4 BAR	LPM at 2.1 BAR	LPM at 2.8 BAR	LPM at 3.4 BAR	LPM at 4.1 BAR	LPM at 4.8 BAR
500	382	360	291	193	45		
540	420	413	356	280	178	42	
600	450	447	424	367	299	204	87

### 9028C-O-SP

#### Metric Units

RPM	LPM at .07 BAR	LPM at 1.4 BAR	LPM at 2.1 BAR	LPM at 2.8 BAR	LPM at 3.4 BAR	LPM at 4.1 BAR
800	344	307	216	72		
940	397	382	318	227	95	
1000	443	432	394	329	246	125

# Gear Driven, Polypropylene

## Series 9000P-0



### Upgrade Options:

- Increase dry-run and abrasive resistance with Life Guard Seals
  - Life Guard seals are the OEM standard

### Features

- Planetary oil-bath gear drive
- Port sizes: 1-1/2" NPT inlet, 1-1/4" NPT outlet
- Max. fluid temperature: 140°F/60°C
- Housing: Polypropylene
- Impeller: Polypropylene
- Pump shaft rotation: Counter clockwise when looking at the shaft end
- Pump seals: Viton®/ceramic standard; Life Guard silicon carbide (B) available
- Life Guard seals are the industry standard on OEM equipment
- Weight: 37 lbs./16.8 kg

### Order Information

Model Number	Max GPM	Max LPM	Max PSI	Max BAR	Max RPM	PTO Output	Locking Collar Kit
9006P-0	97	367	83	5.7	600	1 3/8" 6 spline [SAE] 540 rpm female	x
9008P-0	94	355	67	4.6	1000	1 3/8" 21 spline [SAE] 1000 rpm female	x
9016P-0	97	367	83	5.7	600	1" (25.4 mm) solid shaft	
9018P-0	94	355	67	4.6	1000	1" (25.4 mm) solid shaft	
3430-0333	Seal and o-ring repair kit						
3430-0590	Life Guard silicon carbide seal kit						

Life Guard silicon carbide seal - Add suffix "B" (i.e.: 9006P-0-B)

### 9006P-0, 9016P-0

#### U.S. Units

RPM	GPM at 10 PSI	GPM at 20 PSI	GPM at 30 PSI	GPM at 40 PSI	GPM at 50 PSI	GPM at 60 PSI	GPM at 70 PSI
450	73	63	52	34			
500	81	77	67	55	37		
550	88	85	78	68	56	36	
600	97	97	93	85	76	66	52

### 9006P-0, 9016P-0

#### Metric Units

RPM	LPM at 0.7 BAR	LPM at 1.4 BAR	LPM at 2.1 BAR	LPM at 2.8 BAR	LPM at 3.4 BAR	LPM at 4.1 BAR	LPM at 4.8 BAR
450	276	239	196	129			
500	307	291	255	208	142		
550	333	323	295	257	210	137	
600	367	367	354	323	288	249	198

### 9008P-0, 9018P-0

#### U.S. Units

RPM	GPM at 10 PSI	GPM at 20 PSI	GPM at 30 PSI	GPM at 40 PSI	GPM at 50 PSI	GPM at 60 PSI
800	70	64	53	34		
900	83	79	70	58	42	
1000	96	92	86	78	67	52

### 9008P-0, 9018P-0

#### Metric Units

RPM	LPM at 0.7 BAR	LPM at 1.4 BAR	LPM at 2.1 BAR	LPM at 2.8 BAR	LPM at 3.4 BAR	LPM at 4.1 BAR
800	314	243	200	128		
900	363	299	265	220	161	
1000	327	348	327	296	254	198

# Gear Driven, Cast Iron

## Series 9047C



### Features

- Parallel oil-bath gear drive
- Max. fluid temperature: 140° F/60° C
- Impeller: Nylon
- Pump shaft rotation: Counter clockwise when looking at the shaft end
- Life Guard silicon carbide seal standard for increased life and dry-run protection
- Life Guard seals are the industry standard on OEM equipment
- Available in NPT and BSP self-priming versions

### Order Information

Model Number	Max GPM	Max LPM	Max PSI	Max BAR	Max RPM	PTO Output	Port Sizes
9047C	213	805	180	12.4	540	1-3/8" (SAE) 540 RPM Male	2" NPT inlet x 1-1/2" NPT outlet
9047C-SP	195	740	170	11.7	540	1-3/8" (SAE) 540 RPM Male	2" NPT inlet x 2" NPT outlet
9047C-BSP	195	740	170	11.7	540	1-3/8" (SAE) 540 RPM Male	2" BSP inlet x 2" BSP outlet
3430-0779	Seal & O-ring repair kit						

### 9047C

### U.S. Units

RPM	GPM at 20 PSI	GPM at 30 PSI	GPM at 40 PSI	GPM at 50 PSI	GPM at 60 PSI	GPM at 70 PSI	GPM at 80 PSI	GPM at 90 PSI	GPM at 100 PSI	GPM at 110 PSI	GPM at 120 PSI	GPM at 130 PSI	GPM at 140 PSI	GPM at 150 PSI	GPM at 160 PSI	GPM at 170 PSI	GPM at 180 PSI
450	189	189	188	188	186	184	176	168	140	119	66	-	-	-	-	-	-
500	199	199	199	198	197	196	195	194	193	186	172	145	106	-	-	-	-
540	213	211	211	210	209	209	208	207	206	205	201	195	192	174	148	116	66

### 9047C

### Metric Units

RPM	LPM at 1.4 BAR	LPM at 2.1 BAR	LPM at 2.8 BAR	LPM at 3.4 BAR	LPM at 4.1 BAR	LPM at 4.8 BAR	LPM at 5.5 BAR	LPM at 6.2 BAR	LPM at 6.9 BAR	LPM at 7.6 BAR	LPM at 8.3 BAR	LPM at 8.9 BAR	LPM at 9.7 BAR	LPM at 10.3 BAR	LPM at 11.0 BAR	LPM at 11.7 BAR	LPM at 12.4 BAR
450	715	715	712	710	705	695	665	635	530	450	250	-	-	-	-	-	-
500	755	755	755	750	745	742	740	735	730	705	650	550	400	-	-	-	-
540	805	800	800	795	790	790	789	785	778	775	760	740	725	660	560	440	250

### 9047C-SP, 9047C-BSP

### U.S. Units

RPM	GPM at 20 PSI	GPM at 30 PSI	GPM at 40 PSI	GPM at 50 PSI	GPM at 60 PSI	GPM at 70 PSI	GPM at 80 PSI	GPM at 90 PSI	GPM at 100 PSI	GPM at 110 PSI	GPM at 120 PSI	GPM at 130 PSI	GPM at 140 PSI	GPM at 150 PSI	GPM at 160 PSI
450	174	173	169	166	157	140	119	92	61	26	-	-	-	-	-
500	185	182	180	178	174	172	164	153	132	119	95	69	20	-	-
540	195	194	194	193	190	186	184	181	174	162	148	127	99	79	53

### 9047C-SP, 9047C-BSP

### Metric Units

RPM	LPM at 1.4 BAR	LPM at 2.1 BAR	LPM at 2.8 BAR	LPM at 3.4 BAR	LPM at 4.1 BAR	LPM at 4.8 BAR	LPM at 5.5 BAR	LPM at 6.2 BAR	LPM at 6.9 BAR	LPM at 7.6 BAR	LPM at 8.3 BAR	LPM at 8.9 BAR	LPM at 9.7 BAR	LPM at 10.3 BAR	LPM at 11.0 BAR
450	660	655	640	630	595	530	450	350	230	100	-	-	-	-	-
500	700	690	680	675	660	650	620	580	500	450	360	260	75	-	-
540	740	735	735	730	720	705	695	685	660	615	560	480	375	300	200



# Pedestal Mount, Cast Iron & Stainless Steel

## Series 9202C and 9202S



### Upgrade Options:

- Increase dry-run and abrasive resistance with Life Guard Seals
  - Life Guard seals are the OEM standard
- Extend pump life with Stainless Steel
  - Fact: Chemical corrosion, pump cavitation, and abrasive wear are key factors in pump life
  - 316 Stainless Steel pumps provide superior chemical corrosion resistance, while maintaining material strength to prolong the life against abrasive wear
  - 316 Stainless Steel resists cavitation pitting of pumps, extending the wear life
  - Drop in replacements for cast iron pumps

### Features

- Available in cast iron and 316 stainless steel for extended pump life
- Pedestal mount, direct drive
- Port sizes: 1-1/4" NPT inlet, 1" NPT outlet
- Max. fluid temperature: 140°F/60°C
- Impeller: Nylon (cast iron standard); polypropylene (stainless standard)
- Pump shaft rotation: Counter clockwise when looking at the shaft end, 9202S-R is Clockwise
- Pump seals: Viton®/ceramic standard (Life Guard silicon carbide (B) available); Life Guard silicon carbide standard in stainless steel pumps
- Life Guard seals are the industry standard on OEM equipment
- Weight: 18 lbs./8.2 kg

### Order Information

Model Number	Max GPM	Max LPM	Max PSI	Max BAR	Max RPM	Shaft Output
9202C	103	390	170	11.7	6000	5/8" (15.9 mm) solid shaft
9202S	103	390	170	11.7	6000	5/8" (15.9 mm) stainless steel shaft
9202S-R	103	390	170	11.7	6000	5/8" (15.9 mm) stainless steel shaft
3430-0332	Seal and o-ring repair kit					
3430-0589	Life Guard silicon carbide seal kit					

Life Guard silicon carbide seal - Add suffix "B" (i.e.: 9202C-B)

### 9202C, 9202S, 9202S-R

### U.S. Units

RPM	10 PSI		20 PSI		40 PSI		60 PSI		80 PSI		100 PSI		120 PSI		140 PSI	
	GPM	HP	GPM	HP	GPM	HP	GPM	HP	GPM	HP	GPM	HP	GPM	HP	GPM	HP
2400	50	1.3	46	1.2												
3600	67	3.7	66	3.7	62	3.5	34	2.6								
4200	75	5.7	75	5.7	75	5.7	66	5.3	44	4.2						
5000	88	9.3	88	9.3	88	9.3	88	9.3	77	8.6	60	7.5	24	6.4		
6000	103	15.6	103	15.6	103	15.6	103	15.6	103	15.6	100	15.5	91	14.8	75	14

### 9202C, 9202S, 9202S-R

### Metric Units

RPM	0.7 BAR		1.4 BAR		2.8 BAR		4.1 BAR		5.5 BAR		6.9 BAR		8.3 BAR		9.7 BAR	
	LPM	HP	LPM	HP	LPM	HP	LPM	HP	LPM	HP	LPM	HP	LPM	HP	LPM	HP
2400	189	1.3	174	1.2												
3600	254	3.7	250	3.7	235	3.5	129	2.6								
4200	284	5.7	284	5.7	284	5.7	250	5.3	167	4.2						
5000	333	9.3	333	9.3	333	9.3	333	9.3	291	8.6	227	7.5	91	6.4		
6000	390	15.6	390	15.6	390	15.6	390	15.6	390	15.6	379	15.5	344	14.8	284	14

Viton® is a registered trademark of DuPont. Hypro® is a registered trademark of Pentair.

# Pedestal Mount, Cast Iron & Stainless Steel

## Series 9203C and 9203S



### Upgrade Options:

- Increase dry-run and abrasive resistance with Life Guard Seals
  - Life Guard seals are the OEM standard
- Extend pump life with Stainless Steel
  - Fact: Chemical corrosion, pump cavitation, and abrasive wear are key factors in pump life
  - 316 Stainless Steel pumps provide superior chemical corrosion resistance, while maintaining material strength to prolong the life against abrasive wear
  - 316 Stainless Steel resists cavitation pitting of pumps, extending the wear life
  - Drop in replacements for cast iron pumps

### Features

- Available in cast iron and 316 stainless steel for extended pump life
- Pedestal mount, direct drive
- Port sizes: 1-1/2" NPT inlet, 1-1/4" NPT outlet
- 220 x 200 Universal flange available (U)
- Max. fluid temperature: 140°F/60°C
- Impeller: Nylon (cast iron standard); polypropylene (stainless standard); GTX available
- Pump shaft rotation: Counter clockwise when looking at the shaft end; 9203C-R is clockwise
- Pump seals: Cast Iron models – Viton®/ceramic standard; Life Guard silicon carbide (B) available; Stainless Steel models – Life Guard silicon carbide standard
- Life Guard seals are the industry standard on OEM equipment
- Stainless steel models now available with universal flanges
- Weight: 19 lbs./8.6 kg

### For Flanged Connections You Will Also Need:

- Universal Flange Gasket  Universal Flange Clamp

See 250 for details

### Order Information

Model Number	Max GPM	Max LPM	Max PSI	Max PSI (BAR)	Max RPM	Shaft Output
9203C †	140	530	170	11.7	6000	5/8" (15.9 mm) solid shaft
9203C-R (CW)	140	530	170	11.7	6000	5/8" (15.9 mm) solid shaft
9203S †	140	530	170	11.7	6000	5/8" (15.9 mm) stainless steel shaft
9203S-R (CW)	140	530	170	11.7	6000	5/8" (15.9 mm) stainless steel shaft
3430-0332	Seal and o-ring repair kit					
3430-0589	Life Guard silicon carbide seal kit					

† Universal Flange (220 x 200) - Add Suffix "U" (i.e.: 9203C-U)  
Life Guard silicon carbide seal - Add suffix "B" (i.e.: 9203C-B)

### 9203C, 9203S, 9203C-R, 9203S-R

### U.S. Units

RPM	10 PSI		20 PSI		40 PSI		60 PSI		80 PSI		100 PSI		120 PSI		140 PSI	
	GPM	HP	GPM	HP	GPM	HP	GPM	HP	GPM	HP	GPM	HP	GPM	HP	GPM	HP
2400	80	1.9	65	1.8												
3600	105	5.3	105	5.3	92	5.0	50	3.7								
4200	122	8.2	120	7.9	115	7.7	98	7.1	56	5.3						
5000	140	12.6	140	12.6	138	12.6	130	12.2	118	11.6	88	9.9	45	7.2		
5500	140	14.9	140	14.9	138	14.9	135	15.2	130	15.2	118	14.4	90	12.5	60	9.8
6000	140	17.1	140	17.1	140	17.5	140	18.0	135	18.2	132	18	125	18.2	103	16.3

### 9203C, 9203S, 9203C-R, 9203S-R

### Metric Units

RPM	0.7 BAR		1.4 BAR		2.8 BAR		4.1 BAR		5.5 BAR		6.9 BAR		8.3 BAR		9.7 BAR	
	LPM	HP	LPM	HP	LPM	HP	LPM	HP	LPM	HP	LPM	HP	LPM	HP	LPM	HP
2400	303	1.9	246	1.8												
3600	397	5.3	397	5.3	348	5.0	189	3.7								
4200	462	8.2	454	7.9	435	7.7	371	7.1	212	5.3						
5000	530	12.6	530	12.6	522	12.6	492	12.2	447	11.6	333	9.9	170	7.2		
5500	530	14.9	530	14.9	522	14.9	511	15.2	492	15.2	447	14.4	341	12.5	227	9.8
6000	530	17.1	530	17.1	530	17.5	530	18.0	511	18.2	500	18	473	18.2	409	16.3

# Pedestal Mount, Cast Iron & Stainless Steel, Self-Priming

## Series 9203C-SP and 9203S-SP



### Upgrade Options:

- Increase dry-run and abrasive resistance with Life Guard Seals
  - Life Guard seals are the OEM standard
- Extend pump life with Stainless Steel
  - Fact: Chemical corrosion, pump cavitation, and abrasive wear are key factors in pump life
  - 316 Stainless Steel pumps provide superior chemical corrosion resistance, while maintaining material strength to prolong the life against abrasive wear
  - 316 Stainless Steel resists cavitation pitting of pumps, extending the wear life
  - Drop in replacements for cast iron pumps

### Features

- Available in cast iron and 316 stainless steel for extended pump life
- Pedestal mount, direct drive
- Port sizes: 1-1/2" NPT inlet, 1-1/4" NPT outlet (9203C-SP, 9203S-SP); 2" NPT inlet, 2" NPT outlet (9203C-R-SP)
- Max. fluid temperature: 140°F/60°C
- Impeller: Nylon (cast iron standard); polypropylene (stainless steel); GTX available
- Pump shaft rotation: Counter clockwise when looking at the shaft end; 9203C-R-SP is clockwise
- Pump seals: Cast Iron models – Viton®/ceramic standard; Life Guard silicon carbide (B) available; Stainless Steel models – Life Guard silicon carbide standard
- Life Guard seals are the industry standard on OEM equipment
- Weight: 31.7 lbs./14.4 kg – Stainless Steel; 29 lbs./13.2 kg – Cast Iron

### Order Information

Model Number	Max GPM	Max LPM	Max PSI	Max BAR	Max RPM	Shaft Output
9203C-SP	120	454	157	10.8	6000	5/8" (15.9 mm) solid shaft
9203C-R-SP (CW)	140	530	155	10.7	6000	5/8" (15.9 mm) solid shaft
9203S-SP	120	454	157	10.8	6000	5/8" (15.9 mm) stainless steel shaft
3430-0332	Seal and o-ring repair kit					
3430-0589	Life Guard silicon carbide seal kit					
3430-0480SP	Self priming chamber kit					
3430-0482SP	Self priming chamber kit for reverse rotation ONLY					

Life Guard silicon carbide seal - Add suffix "B" (i.e.: 9203C-SP-B)

### 9203C-R-SP

### U.S. Units

RPM	20 PSI		40 PSI		60 PSI		80 PSI		100 PSI		120 PSI		140 PSI	
	GPM	HP	GPM	HP	GPM	HP	GPM	HP	GPM	HP	GPM	HP	GPM	HP
3600	80	3.8	43	2.9										
4200	102	6.1	76	5.4	38	4								
5000	127	10.5	109	9.8	86	8.7	55	7.2	18	5.4				
5500	135	13.5	125	13.1	110	12.3	83	10.9	57	9.3	21	6.9		
6000	138	15.7	132	15.7	122	15.1	111	14.1	93	13.2	67	12.2	32	9.5

### 9203C-R-SP

### Metric Units

RPM	1.4 BAR		2.8 BAR		4.1 BAR		5.5 BAR		6.9 BAR		8.3 BAR		9.7 BAR	
	LPM	HP	LPM	HP	LPM	HP	LPM	HP	LPM	HP	LPM	HP	LPM	HP
4200	386	6.1	288	5.4	144	4								
5000	481	10.5	413	9.8	326	8.7	208	7.2	68	5.4				
5500	511	13.5	473	13.1	416	12.3	314	10.9	216	9.3	79	6.9		
6000	522	15.7	500	15.7	462	15.1	420	14.1	352	13.2	254	12.2	121	9.5

### 9203C-SP, 9203S-SP

### U.S. Units

RPM	20 PSI		40 PSI		60 PSI		80 PSI		100 PSI		120 PSI		140 PSI	
	GPM	HP	GPM	HP	GPM	HP	GPM	HP	GPM	HP	GPM	HP	GPM	HP
3600	101	4.2	60	3.4										
4200	118	6.7	97	6.1	54	4.7								
5000	120	10.1	119	10.3	110	10.1	78	8.7	25	5.8				
5500	120	12.1	119	12.7	116	13.2	110	12.8	79	11.0	29	7.6		
6000	120	14.3	119	15.0	116	15.7	114	16.0	110	16.0	82	14.0	40	10.6

### 9203C-SP, 9203S-SP

### Metric Units

RPM	1.4 BAR		2.8 BAR		4.1 BAR		5.5 BAR		6.9 BAR		8.3 BAR		9.7 BAR	
	LPM	HP	LPM	HP	LPM	HP	LPM	HP	LPM	HP	LPM	HP	LPM	HP
3600	382	4.2	227	3.4										
4200	447	6.7	367	6.1	204	4.7								
5000	458	10.1	450	10.3	416	10.1	295	8.7	95	5.8				
5500	458	12.1	450	12.7	439	13.2	416	12.8	299	11.0	110	7.6		
6000	458	14.3	450	15.0	439	15.7	432	16.0	416	16.0	310	14.0	157	10.6

# Pedestal Mount, Cast Iron

## Series 9205C



### Upgrade Options:

- Increase dry-run and abrasive resistance with Life Guard Seals
  - Life Guard seals are the OEM standard

### Features

- Pedestal mount, direct drive
- Port sizes: 2" NPT inlet, 1-1/2" NPT outlet
- Max. fluid temperature: 140°F/60°C
- Housing: Cast iron
- Impeller: Nylon
- Pump shaft rotation: Counter clockwise when looking at the shaft end
- Pump seals: Viton®/ceramic standard; Life Guard silicon carbide (B) available
- Life Guard seals are the industry standard on OEM equipment
- Weight: 47 lbs./21.4 kg

### Order Information

Model Number	Max GPM	Max LPM	Max PSI	Max BAR	Max RPM	Shaft Output
9205C	180	681	196	13.5	4200	7/8" [22.2 mm] solid keyed shaft
3430-0537	Seal and o-ring repair kit					
3430-0646	Life Guard silicon carbide seal kit					

Life Guard silicon carbide seal - Add suffix "B" (i.e.: 9205C-B)

### 9205C

### U.S. Units

RPM	20 PSI		40 PSI		60 PSI		80 PSI		100 PSI		120 PSI		140 PSI		160 PSI	
	GPM	HP	GPM	HP	GPM	HP	GPM	HP	GPM	HP	GPM	HP	GPM	HP	GPM	HP
3000	165	11.4	164	11.7	154	11.6	104	9.5								
3400	175	14.8	175	15.5	173	16.3	168	16.3	127	14.2	43	8.7				
3800	180	18.2	180	18.8	180	19.8	178	21.1	173	21.8	156	20.7	112	17.5		
4200	180	21.9	180	22.0	180	24.0	180	25.3	180	26.9	177	27.9	173	28.1	157	26.4

### 9205C

### Metric Units

RPM	1.4 BAR		2.8 BAR		4.1 BAR		5.5 BAR		6.9 BAR		8.3 BAR		9.7 BAR		11.0 BAR	
	LPM	HP	LPM	HP	LPM	HP	LPM	HP	LPM	HP	LPM	HP	LPM	HP	LPM	HP
3000	625	11.4	621	11.7	583	11.6	394	9.5								
3400	662	14.8	662	15.5	655	16.3	636	16.3	481	14.2	163	8.7				
3800	681	18.2	681	18.8	681	19.8	674	21.1	655	21.8	591	20.7	424	17.5		
4200	681	21.9	681	22.0	681	24.0	681	25.3	681	26.9	670	27.9	655	28.1	594	26.4

# Pedestal Mount, Cast Iron, Self-Priming

## Series 9205C-SP



### Upgrade Options:

- Increase dry-run and abrasive resistance with Life Guard Seals
  - Life Guard seals are the OEM standard

### Features

- Pedestal mount, direct drive
- Port sizes:
  - 2" NPT inlet, 2" NPT outlet [9205C-SP]
  - 2" BSP inlet, 2" BSP outlet [9205C-BSP]
- Max. fluid temperature: 140°F/60°C
- Housing: Cast iron
- Impeller: Nylon
- Pump shaft rotation: Counter clockwise when looking at the shaft end
- Pump seals: Viton®/ceramic standard; Life Guard silicon carbide (B) available
- Life Guard seals are the industry standard on OEM equipment
- Weight: 48 lbs./21.8 kg

### Order Information

Model Number	Max GPM	Max LPM	Max PSI	Max BAR	Max RPM	Shaft Output
9205C-SP	160	606	145	10.0	3800	7/8" (22.2 mm) solid keyed shaft
9205C-BSP	160	606	145	10.0	3800	7/8" (22.2 mm) solid keyed shaft
3430-0537	Seal and o-ring repair kit					
3430-0646	Life Guard silicon carbide seal kit					
3430-0481SP	Self priming chamber kit					

Life Guard silicon carbide seal - Add suffix "B" (i.e.: 9205C-SP-B)

### 9205C-SP, 9205C-BSP

### U.S. Units

RPM	GPM at 40 PSI	GPM at 50 PSI	GPM at 60 PSI	GPM at 70 PSI	GPM at 80 PSI	GPM at 90 PSI	GPM at 100 PSI	GPM at 110 PSI	GPM at 120 PSI	GPM at 130 PSI	GPM at 140 PSI
3400	155	154	153	150	131	110	84	35			
3600	158	157	156	155	153	137	114	88	58		
3800	160	159	158	157	156	155	142	123	102	74	28

### 9205C-SP, 9205C-BSP

### Metric Units

RPM	LPM at 2.8 BAR	LPM at 3.4 BAR	LPM at 4.1 BAR	LPM at 4.8 BAR	LPM at 5.5 BAR	LPM at 6.2 BAR	LPM at 6.9 BAR	LPM at 7.6 BAR	LPM at 8.3 BAR	LPM at 8.9 BAR	LPM at 9.7 BAR
3400	587	583	579	568	496	416	318	132			
3600	598	594	591	587	579	518	432	333	220		
3800	606	602	598	594	591	587	538	466	383	280	106

# Pedestal Mount, Cast Iron & Stainless Steel

## Series 9206C and 9206S



### Upgrade Options:

- Increase dry-run and abrasive resistance with Life Guard Seals
  - Life Guard seals are the OEM standard
- Extend pump life with Stainless Steel
  - Fact: Chemical corrosion, pump cavitation, and abrasive wear are key factors in pump life
  - 316 Stainless Steel pumps provide superior chemical corrosion resistance, while maintaining material strength to prolong the life against abrasive wear
  - 316 Stainless Steel resists cavitation pitting of pumps, extending the wear life
  - Drop in replacements for cast iron pumps

### Features

- Available in cast iron and 316 stainless steel for extended pump life
- Pedestal mount, direct drive
- Port sizes: 2" NPT inlet, 1-1/2" NPT outlet
- 220 x 220 (U) and 300 x 220 (-3U models) universal flange available
- Max. fluid temperature: 140°F/60°C
- Impeller: Nylon (standard in cast iron); polypropylene (standard in stainless steel); GTX available
- Pump shaft rotation: Counter clockwise when looking at the shaft end
- Pump seals: Cast Iron models – Viton®/ceramic standard; Life Guard silicon carbide (B) available; Stainless Steel models – Life Guard silicon carbide standard
- Life Guard seals are the industry standard on OEM equipment
- Weight: 23 lbs./10.5 kg

### For Flanged Connections You Will Also Need:

- Universal Flange Gasket
- Universal Flange Clamp

See page 252 for details

### Order Information

Model Number	Max GPM	Max LPM	Max PSI	Max BAR	Max RPM	Shaft Output
9206C*	225	852	80	5.5	4200	5/8" ( 15.9 mm) solid shaft
9206S	225	852	80	5.5	4200	5/8" ( 15.9 mm) stainless steel shaft
3430-0332	Seal and o-ring repair kit					
3430-0589	Life Guard silicon carbide seal kit					

\*Universal Flange (220 x 220) - Add Suffix "U" (i.e.: 9206C-U),  
 Universal Flange (300 x 220) - Add Suffix "3U" (i.e.: 9206C-3U),  
 Life Guard silicon carbide seal - Add suffix "B" (i.e.: 9206C-B)

### 9206C, 9206S, 9206C-U, 9206S-3U

### U.S. Units

RPM	10 PSI		20 PSI		30 PSI		40 PSI		50 PSI		60 PSI		70 PSI		80 PSI	
	GPM	HP	GPM	HP	GPM	HP	GPM	HP	GPM	HP	GPM	HP	GPM	HP	GPM	HP
2400	171	2.3	114	2.0												
3600	225	7.0	225	7.1	225	7.5	196	7.3	143	6.1						
4200	225	9.2	225	9.4	225	10.7	225	11.0	225	11.3	202	10.9	158	9.5	80	6.4

### 9206C, 9206S, 9206C-U, 9206S-3U

### Metric Units

RPM	0.7 BAR		1.4 BAR		2.1 BAR		2.8 BAR		3.4 BAR		4.1 BAR		4.8 BAR		5.5 BAR	
	LPM	HP	LPM	HP	LPM	HP	LPM	HP	LPM	HP	LPM	HP	LPM	HP	LPM	HP
2400	647	2.3	432	2.0												
3600	852	7.0	852	7.1	852	7.5	742	7.3	541	6.1						
4200	852	9.2	852	9.4	852	10.7	852	11.0	852	11.3	765	10.9	598	9.5	303	6.4

# Pedestal Mount, Cast Iron

## Series 9208



### Features

- 5" ANSI-flanged inlet x 4" ANSI-flanged outlet
- 316 stainless steel impeller for superior corrosion resistance
- 9208 version includes a solid 416 stainless steel shaft for corrosion resistance
- The 9208 shaft diameter is 1.63" (41.3 mm) to allow direct coupling to electric motors
- Life Guard silicon carbide seal for premium abrasion resistance and dry run protection
- Life Guard seals are the industry standard on OEM equipment
- Pump shaft rotation: Counter clockwise when looking at the shaft end

### Order Information

Model Number	Max GPM	Max LPM	Max PSI	Max BAR	Max RPM	Shaft Output
9208C	1400	5300	85	5.9	3000	1-5/8" (41.3 mm) solid keyed Stainless Steel shaft
3430-0604	Life Guard silicon carbide seal kit					

### 9208C

### U.S. Units

RPM	20 PSI		40 PSI		60 PSI	
	GPM	HP	GPM	HP	GPM	HP
1750	607	10.8				
2500	1071	32.3	852	31.0	474	24.4
2750	1052	38.5	1027	42.0	788	38.2

### 9208C

### Metric Units

RPM	1.4 BAR		2.8 BAR		4.1 BAR	
	LPM	HP	LPM	HP	LPM	HP
1750	2298	10.8				
2500	4054	32.3	3225	31.0	1794	24.4
2750	3982	38.5	3888	42.0	2983	38.2

# Pedestal Mount, Polypropylene

## Series 9203P-S



### Upgrade Options:

- Increase dry-run and abrasive resistance with Life Guard Seals
  - Life Guard seals are the OEM standard

### Features

- Pedestal mount
- For belt and pulley drive
- Port sizes: 1-1/2" NPT inlet, 1-1/4" NPT outlet
- Max. fluid temperature: 140°F/60°C
- Housing: Polypropylene
- Impeller: Polypropylene
- Pump shaft rotation: Counter clockwise 9203P-S, when looking at the shaft end; 9203P-SR is clockwise
- Pump seals: Viton®/ceramic standard; Life Guard silicon carbide (B) available
- Life Guard seals are the industry standard on OEM equipment
- Weight: 14 lbs./6.4 kg

### Order Information

Model Number	Max GPM	Max LPM	Max PSI	Max BAR	Max RPM	Shaft Output
9203P-S	100	379	82	5.7	4200	7/8" (22.2 mm) solid keyed stainless steel shaft
9203P-SR	100	379	82	5.7	4200	7/8" (22.2 mm) solid keyed stainless steel shaft
3430-0333	Seal and o-ring repair kit					
3430-0590	Life Guard silicon carbide seal kit					

Life Guard silicon carbide seal - Add suffix "B" [i.e.: 9203P-S-B]

### 9203P-S, 9203P-SR

### U.S. Units

RPM	10 PSI		20 PSI		30 PSI		40 PSI		50 PSI		60 PSI		70 PSI		80 PSI	
	GPM	HP	GPM	HP	GPM	HP	GPM	HP	GPM	HP	GPM	HP	GPM	HP	GPM	HP
2400	55	1.5	49	1.4	32	1.1										
3600	89	4.4	87	4.3	81	4.1	71	3.9	58	3.6	37	3.1				
4200	100	6.7	100	6.6	97	6.5	90	6.3	82	6.0	71	5.7	60	5.2	39	4.4

### 9203P-S, 9203P-SR

### Metric Units

RPM	0.7 BAR		1.4 BAR		2.1 BAR		2.8 BAR		3.4 BAR		4.1 BAR		4.8 BAR		5.5 BAR	
	LPM	HP	LPM	HP	LPM	HP	LPM	HP	LPM	HP	LPM	HP	LPM	HP	LPM	HP
2400	208	1.5	185	1.4	121	1.1										
3600	337	4.4	329	4.3	307	4.1	269	3.9	220	3.6	140	3.1				
4200	379	6.7	379	6.6	367	6.5	341	6.3	310	6.0	269	5.7	227	5.2	148	4.4



# Flange Mount, Polypropylene

## Series 9213P



### Upgrade Options:

- Increase dry-run and abrasive resistance with Life Guard Seals
  - Life Guard seals are the OEM standard

### Features

- Mounts clockwise rotation (when looking at the shaft end) — for direct mount to gasoline engines
- Shaft: 3/4" (19 mm) hollow, 416 stainless steel
- Port size: 1-1/2" NPT inlet, 1-1/4" NPT outlet
- Max. fluid temperature: 140°F/60°C
- Housing: Polypropylene
- Impeller: Polypropylene
- Flange bolt pattern for 5 hp gas engine
- Pump seals: Viton®/ceramic standard; Life Guard silicon carbide (B) available
- Life Guard seals are the industry standard on OEM equipment
- Weight: 19 lbs./8.6 kg

### Order Information

Model Number	Max GPM	Max LPM	Max PSI	Max BAR	Max RPM	PTO Output
9213P	91	344	65	4.5	3600	3/4" hollow keyed stainless steel shaft for direct coupling to 5hp engine
3430-0333	Seal and o-ring repair kit					
3430-0590	Life Guard silicon carbide seal kit					

Life Guard silicon carbide seal - Add suffix "B" (i.e.: 9213P-B)

### 9213P — Based on 5.5 HP HONDA® Engine U.S. Units

GPM at 0 PSI	GPM at 10 PSI	GPM at 20 PSI	GPM at 30 PSI	GPM at 40 PSI	GPM at 50 PSI	GPM at 60 PSI
92	91	88	81	70	58	42

### 9213P — Based on 5.5 HP HONDA® Engine Metric Units

LPM at 0.0 BAR	LPM at 0.7 BAR	LPM at 1.4 BAR	LPM at 2.1 BAR	LPM at 2.8 BAR	LPM at 3.4 BAR	LPM at 4.1 BAR
348	344	333	307	265	220	159

Honda® is a registered trademark of Honda Motor Co., Ltd.

Viton® is a registered trademark of DuPont. Hypro® is a registered trademark of Pentair Ltd.

# Pedestal Mount, Clutch-Driven, Polypropylene

## Series 9260P



### Upgrade Options:

- Increase dry-run and abrasive resistance with Life Guard Seals
  - Life Guard seals are the OEM standard

### Features

- Pedestal mount with DC clutch drive
- Port sizes: 1-1/2" NPT inlet, 1-1/4" NPT outlet
- Max. fluid temperature: 140°F/60°C
- Housing: Polypropylene
- Impeller: Polypropylene
- Pump shaft rotation: Counter clockwise 9260P, when looking at the shaft end; 9260P-R is clockwise
- Pump seals: Viton®/ceramic standard; Life Guard silicon carbide (B) available
- Life Guard seals are the industry standard on OEM equipment
- Clutch: 12 volt with 5-1/2" (140 mm) diameter A-section pulley (part # 2526-0011)
- Weight: 19 lbs./8.6 kg

### Order Information

Model Number	Max GPM	Max LPM	Max PSI	Max BAR	Max RPM	Rotation
9260P	100	379	82	5.7	4200	CCW
9260P-R	100	379	82	5.7	4200	CW
3430-0333	Seal and o-ring repair kit					
3430-0590	Life Guard silicon carbide seal kit					

Life Guard silicon carbide seal - Add suffix "B" (i.e.: 9260P-B)

### 9260P, 9260P-R

### U.S. Units

RPM	10 PSI		20 PSI		30 PSI		40 PSI		50 PSI		60 PSI		70 PSI		80 PSI	
	GPM	HP	GPM	HP	GPM	HP	GPM	HP	GPM	HP	GPM	HP	GPM	HP	GPM	HP
2400	55	1.5	49	1.4	32	1.1										
3600	89	4.4	87	4.3	81	4.1	71	3.9	58	3.6	37	3.1				
4200	100	6.7	100	6.6	97	6.5	90	6.3	82	6.0	71	5.7	60	5.2	39	4.4

### 9260P, 9260P-R

### Metric Units

RPM	0.7 BAR		1.4 BAR		2.1 BAR		2.8 BAR		3.4 BAR		4.1 BAR		4.8 BAR		5.5 BAR	
	LPM	HP	LPM	HP	LPM	HP	LPM	HP	LPM	HP	LPM	HP	LPM	HP	LPM	HP
2400	208	1.5	185	1.4	121	1.1										
3600	337	4.4	329	4.3	307	4.1	269	3.9	220	3.6	140	3.1				
4200	379	6.7	379	6.6	367	6.5	341	6.3	310	6.0	269	5.7	227	5.2	148	4.4

# Pedestal Mount, Clutch-Driven, Cast Iron & Stainless Steel

## Series 9262C-C and 9262S-C



### Upgrade Options:

- Increase dry-run and abrasive resistance with Life Guard Seals
  - Life Guard seals are the OEM standard
- Extend pump life with Stainless Steel
  - Fact: Chemical corrosion, pump cavitation, and abrasive wear are key factors in pump life
  - 316 Stainless Steel pumps provide superior chemical corrosion resistance, while maintaining material strength to prolong the life against abrasive wear
  - 316 Stainless Steel resists cavitation pitting of pumps, extending the wear life
  - Drop in replacements for cast iron pumps

### Features

- Pedestal mount with DC clutch drive
- Double "A" groove pulley (5"/125 mm diameter)
- Port sizes: 1-1/4" NPT inlet, 1" NPT outlet
- Max. fluid temperature: 140°F/60°C
- Available in cast iron and 316 stainless steel for extended pump life
- Impeller: Nylon (standard in cast iron); polypropylene (standard in stainless steel); GTX available
- Pump shaft rotation: Counter clockwise when looking at the shaft end; Clockwise for -CR models
- Pump seals: Cast Iron models – Viton®/ceramic standard; Life Guard silicon carbide (B) available; Stainless Steel models – Life Guard silicon carbide standard
- Life Guard seals are the industry standard on OEM equipment
- Amp draw: 45 watts at 12 volts
- Weight: 23 lbs./10.5 kg

### Order Information

Model Number	Max GPM	Max LPM	Max PSI	Max PSI	Max RPM	Rotation
9262C-C	88	333	114	7.9	5000	CCW*
9262S-C	145	549	114	7.9	5000	CCW*
9262S-CR	145	549	114	7.9	5000	CW*
3430-0332	Seal and o-ring repair kit					
3430-0589	Life Guard silicon carbide seal kit					

Life Guard silicon carbide seal - Add suffix "B" (i.e.: 9262C-CB) \*CCW (counterclockwise) CW (clockwise) are determined when looking at the shaft end.

### 9262C-C

### U.S. Units

RPM	10 PSI		20 PSI		40 PSI		60 PSI		80 PSI		100 PSI	
	GPM	HP	GPM	HP	GPM	HP	GPM	HP	GPM	HP	GPM	HP
2400	50	1.3	46	1.2								
3600	67	3.7	66	3.7	62	3.5	25	2.8				
4200	75	5.7	75	5.7	75	5.7	66	5.3	40	4.6		
5000	88	9.3	88	9.3	88	9.3	88	9.3	77	8.6	60	7.5

### 9262C-C

### Metric Units

RPM	0.7 BAR		1.4 BAR		2.8 BAR		4.1 BAR		5.5 BAR		6.9 BAR	
	LPM	HP	LPM	HP	LPM	HP	LPM	HP	LPM	HP	LPM	HP
2400	189	1.3	174	1.2								
3600	254	3.7	250	3.7	235	3.5	95	2.8				
4200	284	5.7	284	5.7	284	5.7	250	5.3	151	4.6		
5000	333	9.3	333	9.3	333	9.3	333	9.3	291	8.6	227	7.5

### 9262S-C, 9262S-CR

### U.S. Units

RPM	10 PSI		20 PSI		40 PSI		60 PSI		80 PSI		100 PSI	
	GPM	HP	GPM	HP	GPM	HP	GPM	HP	GPM	HP	GPM	HP
2400	73	1.4	55	1.2								
3600	112	4.5	109	4.5	86	4.0	25	2.8				
4200	128	7.1	127	7.1	116	6.8	92	6.1	40	4.6		
5000	145	11.8	145	11.8	143	11.7	133	11.3	115	10.4	86	9.1

### 9262S-C, 9262S-CR

### Metric Units

RPM	0.7 BAR		1.4 BAR		2.8 BAR		4.1 BAR		5.5 BAR		6.9 BAR	
	LPM	HP	LPM	HP	LPM	HP	LPM	HP	LPM	HP	LPM	HP
2400	276	1.4	208	1.2								
3600	424	4.5	413	4.5	326	4.0	95	2.8				
4200	484	7.1	481	7.1	439	6.8	348	6.1	151	4.6		
5000	549	11.8	549	11.8	541	11.7	503	11.3	435	10.4	326	9.1

# Pedestal Mount, Clutch-Driven, Cast Iron & Stainless Steel, Self-Priming

## Series 9263C-SP and 9263S-SP



### Upgrade Options:

- Increase dry-run and abrasive resistance with Life Guard Seals
  - Life Guard seals are the OEM standard
- Extend pump life with Stainless Steel
  - Fact: Chemical corrosion, pump cavitation, and abrasive wear are key factors in pump life
  - 316 Stainless Steel pumps provide superior chemical corrosion resistance, while maintaining material strength to prolong the life against abrasive wear
  - 316 Stainless Steel resists cavitation pitting of pumps, extending the wear life
  - Drop in replacements for cast iron pumps

### Features

- Available in cast iron and 316 stainless steel for extended pump life
- Double "A" groove pulley (5"/125 mm diameter)
- Pedestal mount with DC clutch drive
- Max fluid temperature: 140° F/60° C
- Impeller: Nylon (standard in cast iron); polypropylene (standard in stainless steel); GTX available
- Pump seals: Cast Iron models - Viton®/ceramic standard; Life Guard silicon carbide (B) available; Stainless Steel models - Life Guard silicon carbide standard
- Life Guard seals are the industry standard on OEM equipment
- Amp draw: 45 watts at 12 volts

### Order Information

Model Number	Max GPM	Max LPM	Max PSI	Max BAR	Max RPM	Rotation	Port Sizes
9263C-CR-SP	127	481	110	7.6	5000	CW*	2" NPT inlet x 2" NPT outlet
9263C-CR-SP-B	127	481	110	7.6	5000	CW*	2" NPT inlet x 2" NPT outlet
9263C-C-SP	120	454	110	7.6	5000	CCW*	1-1/2" NPT inlet x 1-1/4" NPT outlet
9263S-C-SP	120	454	110	7.6	5000	CCW*	1-1/2" NPT inlet x 1-1/4" NPT outlet
3430-0332	Seal and o-ring repair kit						
3430-0589	Life Guard silicon carbide seal kit						

Life Guard silicon carbide seal - Add suffix "B" [i.e.: 9263-CR-SP-B] \*CCW (counterclockwise) CW (clockwise) are determined when looking at the shaft end.

### 9263C-CR-SP, 9263C-CR-SP-B

### U.S. Units

RPM	20 PSI		30 PSI		40 PSI		50 PSI		60 PSI		70 PSI		80 PSI		90 PSI		100 PSI		
	GPM	HP	GPM	HP	GPM	HP	GPM	HP	GPM	HP	GPM	HP	GPM	HP	GPM	HP	GPM	HP	
3600	80	3.8	64	3.4	43	2.9	17	2.6											
4200	102	6.1	90	5.8	76	5.4	59	4.7	38	4.0	16	3.7							
5000	127	10.5	119	10.2	109	9.8	99	9.3	86	8.7	70	7.9	55	7.2	37	6.2	18	5.4	

### 9263C-CR-SP, 9263C-CR-SP-B

### Metric Units

RPM	1.4 BAR		2.1 BAR		2.8 BAR		3.4 BAR		4.1 BAR		4.8 BAR		5.5 BAR		6.2 BAR		6.9 BAR		
	LPM	HP	LPM	HP	LPM	HP	LPM	HP	LPM	HP	LPM	HP	LPM	HP	LPM	HP	LPM	HP	
3600	303	3.8	242	3.4	163	2.9	64	2.6											
4200	386	6.1	341	5.8	288	5.4	223	4.7	144	4.0	61	3.7							
5000	481	10.5	450	10.2	413	9.8	375	9.3	326	8.7	265	7.9	208	7.2	140	6.2	68	5.4	

### 9263C-C-SP, 9263S-C-SP

### U.S. Units

RPM	20 PSI		30 PSI		40 PSI		50 PSI		60 PSI		70 PSI		80 PSI		90 PSI		100 PSI		
	GPM	HP	GPM	HP	GPM	HP	GPM	HP	GPM	HP	GPM	HP	GPM	HP	GPM	HP	GPM	HP	
3600	101	4.2	84	3.9	60	3.4	25	2.6											
4200	118	6.7	112	6.7	97	6.1	79	5.5	54	4.7	23	4.0							
5000	120	10.1	120	10.3	119	10.3	117	10.2	110	10.1	96	9.6	78	8.7	52	7.2	25	5.8	

### 9263C-C-SP, 9263S-C-SP

### Metric Units

RPM	1.4 BAR		2.1 BAR		2.8 BAR		3.4 BAR		4.1 BAR		4.8 BAR		5.5 BAR		6.2 BAR		6.9 BAR		
	LPM	HP	LPM	HP	LPM	HP	LPM	HP	LPM	HP	LPM	HP	LPM	HP	LPM	HP	LPM	HP	
3600	382	4.2	318	3.9	227	3.4	95	2.6											
4200	447	6.7	424	6.7	367	6.1	299	5.5	204	4.7	87	4.0							
5000	454	10.1	454	10.3	450	10.3	443	10.2	416	10.1	363	9.6	295	8.7	197	7.2	95	5.8	

# Pedestal Mount, Clutch-Driven, Cast Iron & Stainless Steel

## Series 9263C-C and 9263S-C



### Upgrade Options:

- Increase dry-run and abrasive resistance with Life Guard Seals
  - Life Guard seals are the OEM standard
- Extend pump life with Stainless Steel
  - Fact: Chemical corrosion, pump cavitation, and abrasive wear are key factors in pump life
  - 316 Stainless Steel pumps provide superior chemical corrosion resistance, while maintaining material strength to prolong the life against abrasive wear
  - 316 Stainless Steel resists cavitation pitting of pumps, extending the wear life
  - Drop in replacements for cast iron pumps

### Features

- Available in cast iron and 316 stainless steel for extended pump life
- Pedestal mount with DC clutch drive
- Double "A" groove pulley (5"/125 mm diameter)
- Port sizes: 1-1/2" NPT inlet, 1-1/4" NPT outlet (BSP available on 9263C)
- 220 x 200 universal flange available (U)
- Stainless steel models now available with universal flanges
- Max. fluid temperature: 140°F/60°C
- Impeller: Nylon (standard in cast iron); polypropylene (standard in stainless steel); GTX available
- Pump seals: Cast Iron models – Viton®/ceramic standard; Life Guard silicon carbide (B) available; Stainless Steel models – Life Guard silicon carbide standard
- Life Guard seals are the industry standard on OEM equipment
- Amp draw: 45 watts at 12 volts
- Weight: 23 lbs./10.5 kg

### For Flanged Connections You Will Also Need:

- Universal Flange Gasket
- Universal Flange Clamp

See page 252 for details

### Order Information

Model Number	Max GPM	Max LPM	Max PSI	Max BAR	Max RPM	Rotation
9263C-C † (BSP Version - 9263C-BT)	140	530	114	7.9	5000	CCW*
9263C-CR	140	530	114	7.9	5000	CW*
9263S-C †	140	530	114	7.9	5000	CCW*
9263S-CR	140	530	114	7.9	5000	CW*
3430-0332	Seal and o-ring repair kit					
3430-0589	Life Guard silicon carbide seal kit					

† Universal Flange [220 x 200] - Add Suffix "U" (i.e.: 9263C-C-U)

Life Guard silicon carbide seal - Add suffix "B" (i.e.: 9263C-CB)

\*CCW (counterclockwise) CW (clockwise) are determined when looking at the shaft end.

### 9263C-C, 9263S-C, 9263C-CR, 9263S-CR, 9263C-C-U, 9263S-C-U

### U.S. Units

RPM	10 PSI		20 PSI		40 PSI		60 PSI		80 PSI		100 PSI	
	GPM	HP	GPM	HP	GPM	HP	GPM	HP	GPM	HP	GPM	HP
2400	80	1.9	65	1.8								
3600	105	5.3	105	5.3	92	5.0	50	3.7				
4200	122	8.2	120	7.9	115	7.7	98	7.1	56	5.3		
5000	140	12.6	140	12.6	138	12.6	130	12.2	118	11.6	88	9.9

### 9263C-C, 9263S-C, 9263C-CR, 9263S-CR, 9263C-C-U, 9263S-C-U

### Metric Units

RPM	0.7 BAR		1.4 BAR		2.8 BAR		4.1 BAR		5.5 BAR		6.9 BAR	
	LPM	HP	LPM	HP	LPM	HP	LPM	HP	LPM	HP	LPM	HP
2400	303	1.9	246	1.8								
3600	397	5.3	397	5.3	348	5.0	189	3.7				
4200	462	8.2	454	7.9	435	7.7	371	7.1	212	5.3		
5000	530	12.6	530	12.6	522	12.6	492	12.2	447	11.6	333	9.9

# Hydraulically-Driven, Cast Iron and Stainless Steel

## Series 9302C and 9302S



### Upgrade Options:

- Increase dry-run and abrasive resistance with Life Guard Seals
  - Life Guard seals are the OEM standard
- Extend pump life with Stainless Steel
  - Fact: Chemical corrosion, pump cavitation, and abrasive wear are key factors in pump life
  - 316 Stainless Steel pumps provide superior chemical corrosion resistance, while maintaining material strength to prolong the life against abrasive wear
  - 316 Stainless Steel resists cavitation pitting of pumps, extending the wear life
  - Drop in replacements for cast iron pumps

### Features

- Available in cast iron and 316 stainless steel for extended pump life
- Hydraulic motor drive (for open center, closed center and load-sensing systems)
- Port sizes: 1-1/4" NPT inlet, 1" NPT outlet
- Max. fluid temperature: 140°F/60°C
- Impeller: Cast Iron models – Nylon; Stainless Steel models – Polypropylene
- Motor: internal gear gerotor
- Hydraulic ports: 1/2" NPT inlet, 3/4" NPT outlet-HM Series
- Hydraulic ports on GM1 Series: 7/8" 14 UNF #10 SAE
- Pump seals: Cast Iron models – Viton®/ceramic standard; Life Guard silicon carbide (B) available; Stainless Steel models – Life Guard silicon carbide standard
- Life Guard seals are the industry standard on OEM equipment
- Hydraulic motor seal: double-lip Teflon® and case drain available
- Max. motor psi: 3000 (bar: 207)
- Weight: 26 lbs./11.8 kg

### Order Information

Model Number	Max GPM	Max LPM	Max PSI	Max BAR	Max Hyd. GPM	Max Hyd. LPM	Hydraulic Selection System
9302CT-GM1	63	238	90	6.2	3	11.4	Open/Closed
9302C-HM1C	72	273	150	10.3	13	49.2	Open/Closed
9302C-HM2C	65	246	96	6.6	6	22.7	Open/Closed
9302C-HM4C	72	273	120	8.3	7	26.5	Open/Closed
9302ST-GM1	63	238	90	6.2	3	11.4	Open/Closed
9302S-HM1C	72	273	150	10.3	13	49.2	Open/Closed
9302S-HM2C	65	246	96	6.6	6	22.7	Open/Closed
9302S-HM4C	72	273	120	8.3	7	26.5	Open/Closed
3430-0332	Seal and o-ring repair kit						
3430-0589	Life Guard silicon carbide seal kit						

Life Guard silicon carbide seal - Add suffix "B" (i.e.: 9302CT-GM1-B)

**9302CT-GM1, 9302ST-GM1****U.S. Units**

Hyd. Flow GPM	GPM at 10 PSI	GPM at 20 PSI	GPM at 30 PSI	GPM at 40 PSI	GPM at 50 PSI	GPM at 60 PSI	GPM at 70 PSI	GPM at 80 PSI	GPM at 90 PSI
2.0	51	48	39	21					
2.5	60	59	56	48	37	23			
3.0	63	63	62	61	58	50	39	25	0

**9302CT-GM1, 9302ST-GM1****Metric Units**

Hyd. Flow LPM	LPM at 0.7 BAR	LPM at 1.4 BAR	LPM at 2.1 BAR	LPM at 2.8 BAR	LPM at 3.5 BAR	LPM at 4.2 BAR	LPM at 4.9 BAR	LPM at 5.6 BAR	LPM at 6.3 BAR
7.6	193	182	148	79					
9.5	227	223	212	182	140	87			
11.4	238	238	235	231	220	189	148	95	0

**9302C-HM1C, 9302S-HM1C****U.S. Units**

Hyd. Flow GPM	GPM at 40 PSI	GPM at 50 PSI	GPM at 60 PSI	GPM at 70 PSI	GPM at 80 PSI	GPM at 90 PSI	GPM at 100 PSI	GPM at 110 PSI	GPM at 120 PSI	GPM at 130 PSI	GPM at 140 PSI
11	72	72	71	65	56	45	29				
12	72	72	72	72	70	63	53	40			
13	72	72	72	72	72	71	68	63	56	48	35

**9302C-HM1C, 9302S-HM1C****Metric Units**

Hyd. Flow LPM	LPM at 2.8 BAR	LPM at 3.4 BAR	LPM at 4.1 BAR	LPM at 4.8 BAR	LPM at 5.5 BAR	LPM at 6.2 BAR	LPM at 6.9 BAR	LPM at 7.6 BAR	LPM at 8.3 BAR	LPM at 9.0 BAR	LPM at 9.7 BAR
41.6	273	273	269	246	212	170	110				
45.4	273	273	273	273	265	238	201	151			
49.2	273	273	273	273	273	269	257	238	212	182	132

**9302C-HM2C, 9302S-HM2C****U.S. Units**

Hyd. Flow GPM	GPM at 10 PSI	GPM at 20 PSI	GPM at 30 PSI	GPM at 40 PSI	GPM at 50 PSI	GPM at 60 PSI	GPM at 70 PSI	GPM at 80 PSI	GPM at 90 PSI
4	54	49	42	34	19				
5	59	57	50	42	34	25	11		
6	64	63	60	52	44	36	27	18	9

**9302C-HM2C, 9302S-HM2C****Metric Units**

Hyd. Flow LPM	LPM at 0.7 BAR	LPM at 1.4 BAR	LPM at 2.1 BAR	LPM at 2.8 BAR	LPM at 3.4 BAR	LPM at 4.1 BAR	LPM at 4.8 BAR	LPM at 5.5 BAR	LPM at 6.2 BAR
15.1	204	185	159	129	72				
18.9	223	216	189	159	129	95	42		
22.7	244	238	227	197	167	136	102	68	34

**9302C-HM4C, 9302S-HM4C****U.S. Units**

Hyd. Flow GPM	GPM at 10 PSI	GPM at 20 PSI	GPM at 30 PSI	GPM at 40 PSI	GPM at 50 PSI	GPM at 60 PSI	GPM at 70 PSI	GPM at 80 PSI	GPM at 90 PSI	GPM at 100 PSI	GPM at 110 PSI
6	65	63	59	51	41	29	12				
7	72	72	71	67	60	51	42	31	17		
8	72	72	72	72	70	64	57	50	42	32	16

**9302C-HM4C, 9302S-HM4C****Metric Units**

Hyd. Flow LPM	LPM at 0.7 BAR	LPM at 1.4 BAR	LPM at 2.1 BAR	LPM at 2.8 BAR	LPM at 3.4 BAR	LPM at 4.1 BAR	LPM at 4.8 BAR	LPM at 5.5 BAR	LPM at 6.2 BAR	LPM at 6.9 BAR	LPM at 7.6 BAR
22.7	246	238	223	193	155	110	45				
26.5	273	273	269	254	227	193	159	117	64		
30.3	273	273	273	273	265	242	216	189	159	121	61

# Hydraulically-Driven, Cast Iron & Stainless Steel

## Series 9303C and 9303S



### Upgrade Options:

- Increase dry-run and abrasive resistance with Life Guard Seals
  - Life Guard seals are the OEM standard
- Extend pump life with Stainless Steel
  - Fact: Chemical corrosion, pump cavitation, and abrasive wear are key factors in pump life
  - 316 Stainless Steel pumps provide superior chemical corrosion resistance, while maintaining material strength to prolong the life against abrasive wear
  - 316 Stainless Steel resists cavitation pitting of pumps, extending the wear life
  - Drop in replacements for cast iron pumps

### Features

- Available in cast iron and 316 stainless steel for extended pump life
- Hydraulic motor drive (for open center, closed center and load-sensing systems)
- Port sizes: 1-1/2" NPT inlet, 1-1/4" NPT outlet
- 220 x 200 universal flange available (U)
- Max. fluid temperature: 140°F/60°C
- Impeller: Cast Iron models – Nylon; (GTX available)  
Stainless Steel models – Polypropylene
- Motor: internal gear gerotor
- Hydraulic ports: 1/2" NPT inlet, 3/4" NPT outlet
- Pump seals: Cast Iron models – Viton®/ceramic standard; Life Guard silicon carbide (B) available;  
Stainless Steel models – Life Guard silicon carbide standard
- Life Guard seals are the industry standard on OEM equipment
- Hydraulic motor seal: double-lip Teflon® and case drain available
- Max. motor psi: 3000 (bar: 207)
- Stainless steel models now available with universal flanges
- Weight: 26 lbs./11.8 kg

### For Flanged Connections You Will Also Need:

- Universal Flange Gasket
- Universal Flange Clamp

See page 252 for details

### Order Information

Model Number	Max GPM	Max LPM	Max PSI	Max BAR	Max Hyd. GPM	Max Hyd. LPM	Hydraulic Selection System
9303C-HM1C	114	432	130	9.0	13	49.2	Open/Closed
9303C-HM2C	97	367	95	6.5	6	22.7	Open/Closed
9303C-HM3C	125	473	98	6.8	24	90.8	Open/Closed
9303C-HM4C	115	435	93	6.4	7	26.5	Open/Closed
9303C-HM5C	147	556	145	10.0	16	60.6	Open/Closed
9303S-HM1C	114	432	130	9.0	13	49.2	Open/Closed
9303S-HM2C	97	367	95	6.5	6	22.7	Open/Closed
9303S-HM3C	125	473	98	6.8	24	90.8	Open/Closed
9303S-HM4C	115	435	93	6.4	7	26.5	Open/Closed
9303S-HM5C	147	556	145	10.0	16	60.6	Open/Closed
3430-0332	Seal and o-ring repair kit						
3430-0589	Life Guard silicon carbide seal kit						

Universal Flange (220 x 200) - Add suffix "U" (i.e.: 9303C-HM3C-U)  
Life Guard silicon carbide seal - Add suffix "B" (i.e.: 9303C-HM1C-B)

Teflon® is a registered trademark of E.I. DuPont de Nemours and Co.  
Viton® is a registered trademark of DuPont. Hypro® is a registered trademark of Pentair.



**9303C-HM1C, 9303S-HM1C****U.S. Units**

Hyd. Flow GPM	GPM at 20 PSI	GPM at 30 PSI	GPM at 40 PSI	GPM at 50 PSI	GPM at 60 PSI	GPM at 70 PSI	GPM at 80 PSI	GPM at 90 PSI	GPM at 100 PSI	GPM at 110 PSI	GPM at 120 PSI
11	104	101	96	90	82	71	60	47	31		
12	110	109	107	105	101	92	81	67	53	36	9
13	112	111	109	107	104	102	96	85	76	63	33

**9303C-HM1C, 9303S-HM1C****Metric Units**

Hyd. Flow LPM	LPM at 1.4 BAR	LPM at 2.1 BAR	LPM at 2.8 BAR	LPM at 3.4 BAR	LPM at 4.1 BAR	LPM at 4.8 BAR	LPM at 5.5 BAR	LPM at 6.2 BAR	LPM at 6.9 BAR	LPM at 7.6 BAR	LPM at 8.3 BAR
41.6	394	382	363	341	310	269	227	178	117		
45.4	416	413	405	397	382	348	307	254	201	136	34
49.2	424	420	413	405	394	386	363	322	288	238	125

**9303C-HM2C, 9303S-HM2C****U.S. Units**

Hyd. Flow GPM	GPM at 10 PSI	GPM at 20 PSI	GPM at 30 PSI	GPM at 40 PSI	GPM at 50 PSI	GPM at 60 PSI	GPM at 70 PSI	GPM at 80 PSI	GPM at 90 PSI
4	70	60	45	25					
5	83	74	65	50	37	22	4		
6	94	86	80	72	62	50	37	22	7

**9303C-HM2C, 9303S-HM2C****Metric Units**

Hyd. Flow LPM	LPM at 0.7 BAR	LPM at 1.4 BAR	LPM at 2.1 BAR	LPM at 2.8 BAR	LPM at 3.4 BAR	LPM at 4.1 BAR	LPM at 4.8 BAR	LPM at 5.5 BAR	LPM at 6.2 BAR
15.1	265	227	170	95					
18.9	314	280	246	189	140	83	15		
22.7	356	326	303	273	235	189	140	83	26

**9303C-HM3C, 9303S-HM3C****U.S. Units**

Hyd. Flow GPM	GPM at 10 PSI	GPM at 20 PSI	GPM at 30 PSI	GPM at 40 PSI	GPM at 50 PSI	GPM at 60 PSI	GPM at 70 PSI	GPM at 80 PSI	GPM at 90 PSI
15	100	92	83	69	47				
18	116	114	108	100	90	76	55	33	
20	125	123	120	114	107	96	85	71	50

**9303C-HM3C, 9303S-HM3C****Metric Units**

Hyd. Flow LPM	LPM at 0.7 BAR	LPM at 1.4 BAR	LPM at 2.1 BAR	LPM at 2.8 BAR	LPM at 3.4 BAR	LPM at 4.1 BAR	LPM at 4.8 BAR	LPM at 5.5 BAR	LPM at 6.2 BAR
56.8	379	348	314	261	178				
68.1	439	432	409	379	341	288	208	125	
75.7	473	466	454	432	405	363	322	269	189

**9303C-HM4C, 9303S-HM4C****U.S. Units**

Hyd. Flow GPM	GPM at 10 PSI	GPM at 20 PSI	GPM at 30 PSI	GPM at 40 PSI	GPM at 50 PSI	GPM at 60 PSI	GPM at 70 PSI	GPM at 80 PSI	GPM at 90 PSI
5	84	76	66	52	34				
6	97	92	86	78	67	50	25		
7	110	104	98	91	82	69	55	38	14

**9303C-HM4C, 9303S-HM4C****Metric Units**

Hyd. Flow LPM	LPM at 0.7 BAR	LPM at 1.4 BAR	LPM at 2.1 BAR	LPM at 2.8 BAR	LPM at 3.4 BAR	LPM at 4.1 BAR	LPM at 4.8 BAR	LPM at 5.5 BAR	LPM at 6.2 BAR
18.9	318	288	250	197	129				
22.7	367	348	326	295	254	189	95		
26.5	416	394	371	344	310	261	208	144	53

**9303C-HM5C, 9303S-HM5C****U.S. Units**

Hyd. Flow GPM	GPM at 30 PSI	GPM at 40 PSI	GPM at 50 PSI	GPM at 60 PSI	GPM at 70 PSI	GPM at 80 PSI	GPM at 90 PSI	GPM at 100 PSI	GPM at 110 PSI	GPM at 120 PSI	GPM at 130 PSI
13	113	105	97	86	73	59	44				
14	128	123	116	108	98	88	74	61	44		
15	135	132	126	119	110	100	89	77	66	50	20
16	145	142	137	132	126	117	107	95	83	70	55

**9303C-HM5C, 9303S-HM5C****Metric Units**

Hyd. Flow LPM	LPM at 2.1 BAR	LPM at 2.8 BAR	LPM at 3.4 BAR	LPM at 4.1 BAR	LPM at 4.8 BAR	LPM at 5.5 BAR	LPM at 6.2 BAR	LPM at 6.9 BAR	LPM at 7.6 BAR	LPM at 8.3 BAR	LPM at 9.0 BAR
49.2	428	397	367	326	276	223	167				
53.0	485	466	439	409	371	333	280	231	167		
56.8	511	500	477	450	416	379	337	291	250	189	76
60.6	549	538	519	500	477	443	405	360	314	265	208

# Hydraulically-Driven, Cast Iron & Stainless Steel, Self-Priming

## Series 9303C-SP and 9303S-SP



### Upgrade Options:

- Increase dry-run and abrasive resistance with Life Guard Seals
  - Life Guard seals are the OEM standard
- Extend pump life with Stainless Steel
  - Fact: Chemical corrosion, pump cavitation, and abrasive wear are key factors in pump life
  - 316 Stainless Steel pumps provide superior chemical corrosion resistance, while maintaining material strength to prolong the life against abrasive wear
  - 316 Stainless Steel resists cavitation pitting of pumps, extending the wear life
  - Drop in replacements for cast iron pumps

### Features

- Available in cast iron and 316 stainless steel for extended pump life
- Hydraulic motor drive (for open center, closed center and load-sensing systems)
- Port sizes: 1-1/2" NPT inlet, 1-1/4" NPT outlet
- Max. fluid temperature: 140°F/60°C
- Impeller: Cast Iron models – Nylon; (GTX available)  
Stainless Steel models – Polypropylene
- Motor: internal gear gerotor
- Hydraulic ports: 1/2" NPT inlet, 3/4" NPT outlet
- Max. motor psi: 3000 (bar: 207)
- Pump seals: Cast Iron models – Viton®/ceramic standard; Life Guard silicon carbide (B) available; Stainless Steel models – Life Guard silicon carbide standard
- Life Guard seals are the industry standard on OEM equipment
- Hydraulic motor seal: double-lip Teflon® and case drain available
- Weight: 38 lbs./17.3 kg

### Order Information

Model Number	Max GPM	Max LPM	Max PSI	Max BAR	Max Hyd. GPM	Max Hyd. LPM	Hydraulic Selection System
9303C-HM1C-SP	122	462	130	9.0	13	49.2	Open/Closed
9303C-HM2C-SP	104	398	80	5.5	6	22.7	Open/Closed
9303C-HM3C-SP	120	454	95	6.5	24	90.8	Open/Closed
9303C-HM4C-SP	99	375	97	6.7	7	26.5	Open/Closed
9303C-HM5C-SP	140	530	140	9.7	16	60.5	Open/Closed
9303S-HM1C-SP	114	432	130	9.0	13	49.2	Open/Closed
9303S-HM2C-SP	97	361	95	6.5	6	22.7	Open/Closed
9303S-HM3C-SP	125	473	98	6.8	20	75.7	Open/Closed
9303S-HM4C-SP	115	435	93	6.4	7	26.5	Open/Closed
9303S-HM5C-SP	147	556	145	9.9	16	60.5	Open/Closed
3430-0589	Life Guard silicon carbide seal kit						
3430-0480SP	Self priming chamber kit						

Life Guard silicon carbide seal - Add suffix "B" (i.e.: 9303C-HM1C-SP-B)

Teflon® is a registered trademark of E.I. DuPont de Nemours and Co.  
Viton® is a registered trademark of DuPont. Hypro® is a registered trademark of Pentair.

**9303C-HM1C-SP, 9303S-HM1C-SP****U.S. Units**

Hyd. Flow GPM	GPM at 10 PSI	GPM at 20 PSI	GPM at 30 PSI	GPM at 40 PSI	GPM at 50 PSI	GPM at 60 PSI	GPM at 70 PSI	GPM at 80 PSI	GPM at 90 PSI	GPM at 100 PSI	GPM at 110 PSI
11	119	111	102	89	75	58	42	25			
12	122	120	113	104	94	81	69	55	39	24	
13	122	121	119	111	102	90	78	65	52	39	26

**9303C-HM1C-SP, 9303S-HM1C-SP****Metric Units**

Hyd. Flow LPM	LPM at 0.7 BAR	LPM at 1.4 BAR	LPM at 2.1 BAR	LPM at 2.8 BAR	LPM at 3.4 BAR	LPM at 4.1 BAR	LPM at 4.8 BAR	LPM at 5.5 BAR	LPM at 6.2 BAR	LPM at 6.9 BAR	LPM at 7.6 BAR
41.6	450	420	386	337	284	220	159	95			
45.4	462	454	428	394	356	307	261	208	148	91	
49.2	462	458	450	420	386	341	295	246	197	148	98

**9303C-HM2C-SP, 9303S-HM2C-SP****U.S. Units**

Hyd. Flow GPM	GPM at 10 PSI	GPM at 20 PSI	GPM at 30 PSI	GPM at 40 PSI	GPM at 50 PSI	GPM at 60 PSI	GPM at 70 PSI
4	57	43	26				
5	80	67	53	39	23		
6	98	88	78	67	55	42	29

**9303C-HM2C-SP, 9303S-HM2C-SP****Metric Units**

Hyd. Flow LPM	LPM at 0.7 BAR	LPM at 1.4 BAR	LPM at 2.1 BAR	LPM at 2.8 BAR	LPM at 3.4 BAR	LPM at 4.1 BAR	LPM at 4.8 BAR
15.1	216	163	98				
18.9	303	254	201	148	87		
22.7	371	333	295	254	208	159	110

**9303C-HM3C-SP, 9303S-HM3C-SP****U.S. Units**

Hyd. Flow GPM	GPM at 10 PSI	GPM at 20 PSI	GPM at 30 PSI	GPM at 40 PSI	GPM at 50 PSI	GPM at 60 PSI	GPM at 70 PSI	GPM at 80 PSI
15	104	90	74	55	23			
18	119	113	102	87	69	46		
20	120	119	114	106	91	74	55	33

**9303C-HM3C-SP, 9303S-HM3C-SP****Metric Units**

Hyd. Flow LPM	LPM at 0.7 BAR	LPM at 1.4 BAR	LPM at 2.1 BAR	LPM at 2.8 BAR	LPM at 3.4 BAR	LPM at 4.1 BAR	LPM at 4.8 BAR	LPM at 5.5 BAR
56.8	394	341	280	208	87			
68.1	450	428	386	329	261	174		
75.7	454	450	432	401	344	280	208	125

**9303C-HM4C-SP, 9303S-HM4C-SP****U.S. Units**

Hyd. Flow GPM	GPM at 10 PSI	GPM at 20 PSI	GPM at 30 PSI	GPM at 40 PSI	GPM at 50 PSI	GPM at 60 PSI	GPM at 70 PSI	GPM at 80 PSI
5	72	60	46	30	15			
6	87	79	66	52	38	27	13	
7	95	91	84	71	58	42	30	16

**9303C-HM4C-SP, 9303S-HM4C-SP****Metric Units**

Hyd. Flow LPM	LPM at 0.7 BAR	LPM at 1.4 BAR	LPM at 2.1 BAR	LPM at 2.8 BAR	LPM at 3.4 BAR	LPM at 4.1 BAR	LPM at 4.8 BAR	LPM at 5.5 BAR
18.9	273	227	174	114	57			
22.7	329	299	250	197	144	102	49	
26.5	360	344	318	269	220	159	114	61

**9303C-HM5C-SP, 9303S-HM5C-SP****U.S. Units**

Hyd. Flow GPM	GPM at 10 PSI	GPM at 20 PSI	GPM at 30 PSI	GPM at 40 PSI	GPM at 50 PSI	GPM at 60 PSI	GPM at 70 PSI	GPM at 80 PSI	GPM at 90 PSI	GPM at 100 PSI	GPM at 110 PSI
13	114	111	102	89	75	58	42	25			
14	118	117	113	104	94	81	69	55	39	24	
15	122	121	119	111	102	90	78	65	52	39	26

**9303C-HM5C-SP, 9303S-HM5C-SP****Metric Units**

Hyd. Flow LPM	LPM at 0.7 BAR	LPM at 1.4 BAR	LPM at 2.1 BAR	LPM at 2.8 BAR	LPM at 3.4 BAR	LPM at 4.1 BAR	LPM at 4.8 BAR	LPM at 5.5 BAR	LPM at 6.2 BAR	LPM at 6.9 BAR	LPM at 7.6 BAR
49.2	432	420	386	337	284	220	159	95			
53.0	447	443	428	394	356	307	261	208	148	91	
56.8	462	458	450	420	386	341	295	246	197	148	98

# Hydraulically-Driven, Polypropylene

## Series 9303P



### Upgrade Options:

- Increase dry-run and abrasive resistance with Life Guard Seals
  - Life Guard seals are the OEM standard

### Features

- Hydraulic motor drive (for open center, closed center and load-sensing systems)
- Port sizes: 1-1/2" NPT inlet, 1-1/4" NPT outlet
- Max. fluid temperature: 140°F/60°C
- Housing: Polypropylene
- Impeller: Polypropylene
- Motor: internal gear gerotor
- Hydraulic ports: 1/2" NPT inlet, 3/4" NPT outlet
- Pump seals: Viton®/ceramic standard; Life Guard silicon carbide (B) available
- Life Guard seals are the industry standard on OEM equipment
- Hydraulic motor seal: double-lip Teflon® and case drain available
- Max. motor psi: 3000 (bar: 207)
- Weight: 21 lbs./9.5 kg

### Order Information

Model Number	Max GPM	Max LPM	Max PSI	Max BAR	Max Hyd. GPM	Max Hyd. LPM	Hydraulic Selection System
9303P-HM1C	110	416	130	9.0	13	49.2	Open/Closed
9303P-HM2C	82	310	95	6.5	6	22.7	Open/Closed
9303P-HM3C	110	416	93	6.4	24	90.8	Open/Closed
9303P-HM4C	82	310	84	5.3	7	26.5	Open/Closed
9303P-HM5C	113	427	120	8.3	16	60.5	Open/Closed
3430-0445	Seal and o-ring repair kit						
3430-0593	Life Guard silicon carbide seal kit						

Life Guard silicon carbide seal - Add suffix "B" (i.e.: 9303P-HM1C-B)

## 9303P-HM1C

U.S. Units

Hyd. Flow GPM	GPM at 10 PSI	GPM at 20 PSI	GPM at 30 PSI	GPM at 40 PSI	GPM at 50 PSI	GPM at 60 PSI	GPM at 70 PSI	GPM at 80 PSI	GPM at 90 PSI	GPM at 100 PSI	GPM at 110 PSI	GPM at 120 PSI
11	93	90	86	80	74	67	59	49	36	18		
12	102	99	95	91	87	81	74	66	55	39	19	
13	109	106	103	99	94	88	82	74	65	54	42	28

## 9303P-HM1C

Metric Units

Hyd. Flow LPM	LPM at 0.7 BAR	LPM at 1.4 BAR	LPM at 2.1 BAR	LPM at 2.8 BAR	LPM at 3.4 BAR	LPM at 4.1 BAR	LPM at 4.8 BAR	LPM at 5.5 BAR	LPM at 6.2 BAR	LPM at 6.9 BAR	LPM at 7.6 BAR	LPM at 8.3 BAR
41.6	352	341	326	303	280	254	223	185	136	68		
45.4	386	375	360	344	329	307	280	250	208	148	72	
49.2	413	401	390	375	356	333	310	280	246	204	159	106

## 9303P-HM2C

U.S. Units

Hyd. Flow GPM	GPM at 10 PSI	GPM at 20 PSI	GPM at 30 PSI	GPM at 40 PSI	GPM at 50 PSI	GPM at 60 PSI	GPM at 70 PSI	GPM at 80 PSI	GPM at 90 PSI
5	65	56	46	38	20				
6	74	72	64	56	48	38	21		
7	80	75	70	62	57	48	40	28	9

## 9303P-HM2C

Metric Units

Hyd. Flow LPM	LPM at 0.7 BAR	LPM at 1.4 BAR	LPM at 2.1 BAR	LPM at 2.8 BAR	LPM at 3.4 BAR	LPM at 4.1 BAR	LPM at 4.8 BAR	LPM at 5.5 BAR	LPM at 6.2 BAR
18.9	246	212	174	144	76				
22.7	280	273	242	212	182	144	79		
26.5	303	284	265	235	216	182	151	106	34

## 9303P-HM3C

U.S. Units

Hyd. Flow GPM	GPM at 10 PSI	GPM at 20 PSI	GPM at 30 PSI	GPM at 40 PSI	GPM at 50 PSI	GPM at 60 PSI	GPM at 70 PSI	GPM at 80 PSI	GPM at 90 PSI
15	85	80	70	60	44				
18	100	97	92	84	76	63	48		
20	109	108	104	99	90	82	71	60	39

## 9303P-HM3C

Metric Units

Hyd. Flow LPM	LPM at 0.7 BAR	LPM at 1.4 BAR	LPM at 2.1 BAR	LPM at 2.8 BAR	LPM at 3.4 BAR	LPM at 4.1 BAR	LPM at 4.8 BAR	LPM at 5.5 BAR	LPM at 6.2 BAR
56.8	322	303	265	227	167				
68.1	379	367	348	318	288	238	182		
75.7	413	409	394	375	341	310	269	227	148

## 9303P-HM4C

U.S. Units

Hyd. Flow GPM	GPM at 10 PSI	GPM at 20 PSI	GPM at 30 PSI	GPM at 40 PSI	GPM at 50 PSI	GPM at 60 PSI	GPM at 70 PSI	GPM at 80 PSI
5	60	52	41	26				
6	70	66	58	48	37	21		
7	80	76	70	63	55	45	32	15

## 9303P-HM4C

Metric Units

Hyd. Flow LPM	LPM at 0.7 BAR	LPM at 1.4 BAR	LPM at 2.1 BAR	LPM at 2.8 BAR	LPM at 3.4 BAR	LPM at 4.1 BAR	LPM at 4.8 BAR	LPM at 5.5 BAR
18.9	227	197	155	98				
22.7	265	250	220	182	140	79		
26.5	303	288	265	238	208	170	121	57

## 9303P-HM5C

U.S. Units

Hyd. Flow GPM	GPM at 10 PSI	GPM at 20 PSI	GPM at 30 PSI	GPM at 40 PSI	GPM at 50 PSI	GPM at 60 PSI	GPM at 70 PSI	GPM at 80 PSI	GPM at 90 PSI	GPM at 100 PSI	GPM at 110 PSI
12	94	92	86	78	68	58	44	15			
13	100	98	94	88	79	70	60	48	25		
14	108	107	104	100	94	86	77	68	57	42	
15	113	112	110	106	100	93	86	78	68	56	40

## 9303P-HM5C

Metric Units

Hyd. Flow LPM	LPM at 0.7 BAR	LPM at 1.4 BAR	LPM at 2.1 BAR	LPM at 2.8 BAR	LPM at 3.4 BAR	LPM at 4.1 BAR	LPM at 4.8 BAR	LPM at 5.5 BAR	LPM at 6.2 BAR	LPM at 6.9 BAR	LPM at 7.6 BAR
45.4	356	348	326	295	257	220	167	57			
49.2	379	371	356	333	299	265	227	182	95		
53.0	409	405	394	379	356	326	291	257	216	159	
56.8	428	424	416	401	379	352	326	295	257	212	151

# Hydraulically-Driven, Cast Iron

## Series 9305C



### Upgrade Options:

- Increase dry-run and abrasive resistance with Life Guard Seals
  - Life Guard seals are the OEM standard

### Features

- Available in cast iron
- Hydraulic motor drive (for open center, closed center and load-sensing systems)
- Port sizes: 2" NPT inlet, 1-1/2" NPT outlet
- Max. fluid temperature: 140°F/60°C
- Impeller: Nylon
- Motor: internal gear gerotor
- Hydraulic ports: 1/2" NPT inlet, 3/4" NPT outlet
- Max. motor psi: 3000 (bar: 207)
- Pump seals: Viton®/ceramic standard; Life Guard silicon carbide (B) available
- Life Guard seals are the industry standard on OEM equipment
- Hydraulic motor seal: double-lip Teflon® and case drain available
- Weight: 48 lbs./21.8 kg

### Order Information

Model Number	Max GPM	Max LPM	Max PSI	Max BAR	Max Hyd. GPM	Max Hyd. LPM	Hydraulic Selection System
9305C-HM3C	182	689	156	10.8	19	72	Open/Closed
3430-0500	Seal and o-ring repair kit						
3430-0601	Life Guard silicon carbide seal kit						

Life Guard silicon carbide seal - Add suffix "B" (i.e.: 9305C-HM3C-B)

### 9305C-HM3C

### U.S. Units

Hyd. Flow GPM	GPM at 50 PSI	GPM at 60 PSI	GPM at 70 PSI	GPM at 80 PSI	GPM at 90 PSI	GPM at 100 PSI	GPM at 110 PSI	GPM at 120 PSI	GPM at 130 PSI	GPM at 140 PSI
17	173	164	148	127	97	70	44	14		
18	177	175	168	154	135	109	87	62	34	
19	180	179	177	167	151	134	115	95	72	44

### 9305C-HM3C

### Metric Units

Hyd. Flow LPM	LPM at 3.4 BAR	LPM at 4.1 BAR	LPM at 4.8 BAR	LPM at 5.5 BAR	LPM at 6.2 BAR	LPM at 6.9 BAR	LPM at 7.6 BAR	LPM at 8.3 BAR	LPM at 9.0 BAR	LPM at 9.7 BAR
64.4	655	621	560	481	367	265	167	53		
68.1	670	662	636	583	511	413	329	235	129	
71.9	685	678	670	632	572	507	435	360	273	167

Teflon® is a registered trademark of E.I. DuPont de Nemours and Co.

Viton® is a registered trademark of DuPont. Hypro® is a registered trademark of Pentair.

# Hydraulically-Driven, Cast Iron, Self-Priming

## Series 9305C-SP and 9305C-BSP



### Upgrade Options:

- Increase dry-run and abrasive resistance with Life Guard Seals
  - Life Guard seals are the OEM standard

### Features

- Available in cast iron
- Hydraulic motor drive (for open center, closed center and load-sensing systems)
- Port sizes: 2" NPT inlet, 2" NPT outlet (Model 9305C-HM3C-SP), 2" BSP inlet, 2" BSP outlet (Model 9305C-HM3C-BSP)
- Max. fluid temperature: 140°F/60°C
- Impeller: Nylon
- Motor: internal gear gerotor
- Hydraulic ports: 1/2" NPT inlet, 3/4" NPT outlet
- Max. motor psi: 3000 (bar: 207)
- Pump seals: Viton®/ceramic standard; Life Guard silicon carbide (B) available
- Life Guard seals are the industry standard on OEM equipment
- Hydraulic motor seal: double-lip Teflon® and case drain available
- Weight: 59 lbs./26.8 kg

### Order Information

Model Number	Max GPM	Max LPM	Max PSI	Max BAR	Max Hyd. GPM	Max Hyd LPM	Hydraulic Selection System
9305C-HM3C-SP	155	587	143	9.9	19	72	Open/Closed
9305C-HM3C-BSP	155	587	143	9.9	19	72	Open/Closed
3430-0601	Life Guard silicon carbide seal kit						
3430-0481SP	Self priming chamber kit						

Life Guard silicon carbide seal - Add suffix "B" (i.e.: 9305C-HM3C-B-SP)

### 9305C-HM3C-SP, 9305C-HM3C-BSP

### U.S. Units

Hyd. Flow GPM	GPM at 30 PSI	GPM at 40 PSI	GPM at 50 PSI	GPM at 60 PSI	GPM at 70 PSI	GPM at 80 PSI	GPM at 90 PSI	GPM at 100 PSI	GPM at 110 PSI	GPM at 120 PSI	GPM at 130 PSI
17	148	145	135	118	100	81	60	37	17		
18	150	149	147	138	120	102	81	60	38	14	
19	153	152	150	147	140	120	104	85	66	45	28

### 9305C-HM3C-SP, 9305C-HM3C-BSP

### Metric Units

Hyd. Flow LPM	LPM at 2.1 BAR	LPM at 2.8 BAR	LPM at 3.4 BAR	LPM at 4.1 BAR	LPM at 4.8 BAR	LPM at 5.5 BAR	LPM at 6.2 BAR	LPM at 6.9 BAR	LPM at 7.6 BAR	LPM at 8.3 BAR	LPM at 9.0 BAR
64.4	560	549	511	447	379	307	227	140	64		
68.1	568	564	556	522	454	386	307	227	144	53	
71.9	579	575	568	556	553	454	394	322	250	170	106

Teflon® is a registered trademark of E.I. DuPont de Nemours and Co.

Viton® is a registered trademark of DuPont. Hypro® is a registered trademark of Pentair.

# Hydraulically-Driven, Cast Iron & Stainless Steel

## Series 9306C and 9306S



### Upgrade Options:

- Increase dry-run and abrasive resistance with Life Guard Seals
  - Life Guard seals are the OEM standard
- Extend pump life with Stainless Steel
  - Fact: Chemical corrosion, pump cavitation, and abrasive wear are key factors in pump life
  - 316 Stainless Steel pumps provide superior chemical corrosion resistance, while maintaining material strength to prolong the life against abrasive wear
  - 316 Stainless Steel resists cavitation pitting of pumps, extending the wear life
  - Drop in replacements for cast iron pumps

### Features

- Hydraulic motor drive (for open center, closed center and load-sensing systems)
- Port sizes: 2" NPT inlet, 1-1/2" NPT outlet; 220 x 220 (U) Universal flange available
- Max. fluid temperature: 140°F/60°C
- Available in cast iron and 316 stainless steel for extended pump life
- Impeller: Nylon (cast iron models); polypropylene (stainless steel models); (GTX available)
- Motor: internal gear gerotor
- Hydraulic ports: 1/2" NPT inlet, 3/4" NPT outlet
- Max. motor psi: 3000 (bar: 207)
- Pump seals: Cast Iron models – Viton®/ceramic standard; Life Guard silicon carbide (B) available; Stainless Steel models – Life Guard silicon carbide standard
- Life Guard seals are the industry standard on OEM equipment
- Hydraulic motor seal: double-lip Teflon® and case drain available
- Weight: 33 lbs./15 kg

### For Flanged Connections You Will Also Need:

- Universal Flange Gasket
- Universal Flange Clamp

See page 252 for details

### Order Information

Model Number	Max GPM	Max LPM	Max PSI	Max BAR	Max Hyd. GPM	Max Hyd. LPM	Hydraulic Selection System
9306C-HM1C*	207	784	127	8.8	13	49.2	Open/Closed
9306C-HM3C*	214	810	128	8.8	24	90.8	Open/Closed
9306C-HM5C*	212	803	140	9.6	17	64.4	Open/Closed
9306S-HM1C	207	784	127	8.8	13	49.2	Open/Closed
9306S-HM3C	214	810	128	8.8	24	90.8	Open/Closed
9306S-HM5C	212	803	140	9.6	17	64.4	Open/Closed
3430-0332	Seal and o-ring repair kit						
3430-0589	Life Guard silicon carbide seal kit						

\*Universal Flange (220 x 220) - Add Suffix "U" (i.e.: 9306C-HM3C-U) - Life Guard silicon carbide seat - Add suffix "B" (i.e.: 9306C-HM3C-B)

### 9306C-HM1C, 9306S-HM1C, 9306C-HM1C-U, 9306S-HM1C-U

### U.S. Units

Hyd. Flow GPM	GPM at 30 PSI	GPM at 40 PSI	GPM at 50 PSI	GPM at 60 PSI	GPM at 70 PSI	GPM at 80 PSI	GPM at 90 PSI	GPM at 100 PSI	GPM at 110 PSI	GPM at 120 PSI
11	207	200	186	155	122	88	44			
12	207	207	196	179	149	119	88	53		
13	207	207	207	195	171	144	115	85	53	20

### 9306C-HM1C, 9306S-HM1C, 9306C-HM1C-U, 9306S-HM1C-U

### Metric Units

Hyd. Flow LPM	LPM at 2.1 BAR	LPM at 2.8 BAR	LPM at 3.4 BAR	LPM at 4.1 BAR	LPM at 4.8 BAR	LPM at 5.5 BAR	LPM at 6.2 BAR	LPM at 6.9 BAR	LPM at 7.6 BAR	LPM at 8.3 BAR
41.6	784	757	704	587	462	333	167			
45.4	784	784	742	678	564	450	333	201		
49.2	784	784	784	738	647	545	435	322	201	76

### 9306C-HM3C, 9306S-HM3C, 9306C-HM3C-U, 9306S-HM3C-U

### U.S. Units

Hyd. Flow GPM	GPM at 40 PSI	GPM at 50 PSI	GPM at 60 PSI	GPM at 70 PSI	GPM at 80 PSI	GPM at 90 PSI	GPM at 100 PSI	GPM at 110 PSI	GPM at 120 PSI
18	190	179	159	90					
20	214	203	199	181	139	49			
22	214	214	214	210	198	176	127	16	
24	214	214	214	214	214	210	190	154	101

### 9306C-HM3C, 9306S-HM3C, 9306C-HM3C-U, 9306S-HM3C-U

### Metric Units

Hyd. Flow LPM	LPM at 2.8 BAR	LPM at 3.4 BAR	LPM at 4.1 BAR	LPM at 4.8 BAR	LPM at 5.5 BAR	LPM at 6.2 BAR	LPM at 6.9 BAR	LPM at 7.6 BAR	LPM at 8.3 BAR
68.1	719	678	602	341					
75.7	810	768	753	685	526	185			
83.3	810	810	810	795	750	666	481	61	
90.8	810	810	810	810	810	795	719	583	382

### 9306C-HM5C, 9306S-HM5C, 9306C-HM5C-U, 9306S-HM5C-U

### U.S. Units

Hyd. Flow GPM	GPM at 40 PSI	GPM at 50 PSI	GPM at 60 PSI	GPM at 70 PSI	GPM at 80 PSI	GPM at 90 PSI	GPM at 100 PSI	GPM at 110 PSI	GPM at 120 PSI	GPM at 130 PSI
15	212	212	212	187	150	114	65	19		
16	212	212	212	212	189	158	125	87	42	
17	212	212	212	212	212	189	162	133	102	58

### 9306C-HM5C, 9306S-HM5C, 9306C-HM5C-U, 9306S-HM5C-U

### Metric Units

Hyd. Flow LPM	LPM at 2.8 BAR	LPM at 3.4 BAR	LPM at 4.1 BAR	LPM at 4.8 BAR	LPM at 5.5 BAR	LPM at 6.2 BAR	LPM at 6.9 BAR	LPM at 7.6 BAR	LPM at 8.3 BAR	LPM at 9.0 BAR
56.8	803	803	803	708	568	432	246	72		
60.6	803	803	803	803	715	598	473	329	159	
64.4	803	803	803	803	803	715	613	503	386	220

Teflon® is a registered trademark of E.I. DuPont de Nemours and Co.

Viton® is a registered trademark of DuPont. Hypro® is a registered trademark of Pentair.



# Hydraulically-Driven, Cast Iron & Stainless Steel-3U Flanged

## Series 9306C-3U and 9306S-3U



### Upgrade Options:

- Increase dry-run and abrasive resistance with Life Guard Seals
  - Life Guard seals are the OEM standard
- Extend pump life with Stainless Steel
  - Fact: Chemical corrosion, pump cavitation, and abrasive wear are key factors in pump life
  - 316 Stainless Steel pumps provide superior chemical corrosion resistance, while maintaining material strength to prolong the life against abrasive wear
  - 316 Stainless Steel resists cavitation pitting of pumps, extending the wear life
  - Drop in replacements for cast iron pumps

### Features

- Hydraulic motor drive (for open center, closed center and load-sensing systems)
- Port Sizes: 300 x 220 (3U) Universal flange
- Max. fluid temperature: 140°F/60°C
- Available in cast iron and 316 stainless steel for extended pump life
- Impeller: Nylon (cast iron models); polypropylene (stainless steel models); (GTX available)
- Motor: internal gear gerotor
- Hydraulic ports: 1/2" NPT inlet, 3/4" NPT outlet
- Max. motor psi: 3000 (bar: 207)
- Pump seals: Cast Iron models – Viton®/ceramic standard; Life Guard silicon carbide (B) available; Stainless Steel models – Life Guard silicon carbide
- Life Guard seals are the industry standard on OEM equipment
- Hydraulic motor seal: double-lip Teflon® and case drain available
- Weight: 33 lbs./15 kg

### For Flanged Connections You Will Also Need:

- Universal Flange Gasket    Universal Flange Clamp

See page 252 for details

### Order Information

Model Number	Max GPM	Max LPM	Max PSI	Max BAR	Max Hyd. GPM	Max Hyd. LPM	Hydraulic Selection System
9306C-HM1C-3U	283	1071	127	8.8	13	49.2	Open/Closed
9306C-HM3C-3U	322	1219	128	8.8	24	90.3	Open/Closed
9306C-HM5C-3U	312	1181	140	9.6	17	64.4	Open/Closed
9306S-HM1C-3U	283	1071	127	8.8	13	49.2	Open/Closed
9306S-HM3C-3U	322	1219	128	8.8	24	90.3	Open/Closed
9306S-HM5C-3U	312	1181	140	9.6	17	64.4	Open/Closed
3430-0332	Seal and o-ring repair kit						
3430-0589	Life Guard silicon carbide seal kit						

Life Guard silicon carbide seal - Add suffix "B" (i.e.: 9306C-HM1C-B3U)

### 9306C-HM1C-3U, 9306S-HM1C-3U

### U.S. Units

Hyd. Flow GPM	GPM at 30 PSI	GPM at 40 PSI	GPM at 50 PSI	GPM at 60 PSI	GPM at 70 PSI	GPM at 80 PSI	GPM at 90 PSI	GPM at 100 PSI	GPM at 110 PSI	GPM at 120 PSI
11	255	225	190	155	122	88	44	5		
12	271	242	211	179	149	119	88	53	19	
13	283	258	226	199	171	144	115	85	53	24

### 9306C-HM1C-3U, 9306S-HM1C-3U

### Metric Units

Hyd. Flow LPM	LPM at 2.1 BAR	LPM at 2.8 BAR	LPM at 3.4 BAR	LPM at 4.1 BAR	LPM at 4.8 BAR	LPM at 5.5 BAR	LPM at 6.2 BAR	LPM at 6.9 BAR	LPM at 7.6 BAR	LPM at 8.3 BAR
41.6	965	852	719	587	462	333	167	19		
45.4	1026	916	799	678	564	450	333	201	72	
49.2	1071	977	856	753	647	545	435	322	201	91

### 9306C-HM3C-3U, 9306S-HM3C-3U

### U.S. Units

Hyd. Flow GPM	GPM at 30 PSI	GPM at 40 PSI	GPM at 50 PSI	GPM at 60 PSI	GPM at 70 PSI	GPM at 80 PSI	GPM at 90 PSI	GPM at 100 PSI	GPM at 110 PSI	GPM at 120 PSI
18	285	256	213	165	90					
20	308	297	268	233	192	139	49			
22	312	312	308	288	255	219	176	127	16	
24	322	322	320	316	298	265	231	196	154	101

### 9306C-HM3C-3U, 9306S-HM3C-3U

### Metric Units

Hyd. Flow LPM	LPM at 2.1 BAR	LPM at 2.8 BAR	LPM at 3.4 BAR	LPM at 4.1 BAR	LPM at 4.8 BAR	LPM at 5.5 BAR	LPM at 6.2 BAR	LPM at 6.9 BAR	LPM at 7.6 BAR	LPM at 8.3 BAR
68.1	1079	969	806	624	341					
75.7	1166	1124	1014	882	727	526	185			
83.3	1181	1161	1166	1090	965	829	666	481	61	
90.8	1219	1219	1211	1196	1128	1003	874	742	583	382

### 9306C-HM5C-3U, 9306S-HM5C-3U

### U.S. Units

Hyd. Flow GPM	GPM at 30 PSI	GPM at 40 PSI	GPM at 50 PSI	GPM at 60 PSI	GPM at 70 PSI	GPM at 80 PSI	GPM at 90 PSI	GPM at 100 PSI	GPM at 110 PSI	GPM at 120 PSI	GPM at 130 PSI
15	285	269	242	212	182	149	112	68	19		
16	308	291	269	242	212	179	149	115	78	37	
17	312	312	297	270	242	214	187	154	122	82	44

### 9306C-HM5C-3U, 9306S-HM5C-3U

### Metric Units

Hyd. Flow LPM	LPM at 2.1 BAR	LPM at 2.8 BAR	LPM at 3.4 BAR	LPM at 4.1 BAR	LPM at 4.8 BAR	LPM at 5.5 BAR	LPM at 6.2 BAR	LPM at 6.9 BAR	LPM at 7.6 BAR	LPM at 8.3 BAR	LPM at 8.9 BAR
56.8	1079	1018	916	802	689	564	424	257	72		
60.6	1166	1101	1018	916	802	677	564	435	307	159	
64.4	1181	1181	1124	1022	916	810	708	583	462	310	167

Teflon® is a registered trademark of E.I. DuPont de Nemours and Co.

Viton® is a registered trademark of DuPont. Hypro® is a registered trademark of Pentair.

# Hydraulically-Driven, Cast Iron

## Series 9307C



### For Flanged Connections You Will Also Need:

- Universal Flange Gasket
- Universal Flange Clamp

See page 252 for details

### Features

- Hydraulic motor drive (for open center, closed center and load-sensing systems)
- Port sizes: 3" NPT inlet, 2" NPT outlet
- 300 x 220 universal flange available (U)
- Max. fluid temperature: 140°F/60°C
- Impeller: stainless steel
- Motor: external gear
- Hydraulic ports: -10 SAE inlet and -12 SAE outlet
- Max. motor psi: 3000 (bar: 207)
- Pump seals: Life Guard silicon carbide standard
- Life Guard seals are the industry standard on OEM equipment
- Weight: 86 lbs./39 kg

### Order Information

Model Number	Max GPM	Max LPM	Max PSI	Max BAR	Max Hyd. GPM	Max Hyd. LPM	Hydraulic Selection System
9307C-GM10	370	1400	135	9.3	20	75.7	Open/Closed
9307C-GM12	370	1400	135	9.3	23	87.1	Open/Closed
3430-0604	Life Guard silicon carbide seal kit						

\*Universal Flange (300 x 220) - Add Suffix "U" (i.e.: 9307C-GM10-U)

### 9307C-GM10, 9307C-GM10-U

### U.S. Units

Hyd. Flow GPM	GPM at 30 PSI	GPM at 40 PSI	GPM at 50 PSI	GPM at 60 PSI	GPM at 70 PSI	GPM at 80 PSI	GPM at 90 PSI	GPM at 100 PSI	GPM at 110 PSI
16	282	253	219	168	73				
17	318	288	258	222	174	95			
18	346	318	291	258	222	166	90		
19	361	361	338	311	281	250	201	137	
20	370	370	351	328	301	275	241	184	106

### 9307C-GM10, 9307C-GM10-U

### Metric Units

Hyd. Flow LPM	LPM at 2.1 BAR	LPM at 2.8 BAR	LPM at 3.4 BAR	LPM at 4.1 BAR	LPM at 4.8 BAR	LPM at 5.5 BAR	LPM at 6.2 BAR	LPM at 6.9 BAR	LPM at 7.6 BAR
60.6	1067	958	829	636	276				
64.4	1204	1090	977	840	659	360			
68.1	1310	1204	1101	977	840	628	341		
71.9	1366	1366	1279	1177	1064	946	761	519	
75.7	1400	1400	1329	1241	1139	1041	912	696	401

### 9307C-GM12, 9307C-GM12-U

### U.S. Units

Hyd. Flow GPM	GPM at 30 PSI	GPM at 40 PSI	GPM at 50 PSI	GPM at 60 PSI	GPM at 70 PSI	GPM at 80 PSI	GPM at 90 PSI	GPM at 100 PSI	GPM at 110 PSI
16	222	180	115						
17	246	212	166	92					
18	274	245	209	157	58				
19	302	272	242	203	150				
20	326	298	271	240	196	142			
21	345	324	297	269	238	194	140		
22		345	322	297	270	236	193	138	
23		370	344	323	299	273	235	194	137

### 9307C-GM12, 9307C-GM12-U

### Metric Units

Hyd. Flow LPM	LPM at 2.1 BAR	LPM at 2.8 BAR	LPM at 3.4 BAR	LPM at 4.1 BAR	LPM at 4.8 BAR	LPM at 5.5 BAR	LPM at 6.2 BAR	LPM at 6.9 BAR	LPM at 7.6 BAR
60.6	840	681	435						
64.4	931	802	628	348					
68.1	1037	927	791	594	220				
71.9	1143	1030	916	768	568				
75.7	1234	1128	1026	908	742	537			
79.5	1306	1226	1124	1018	901	734	530		
83.3		1306	1219	1124	1022	893	731	522	
87.1		1400	1302	1223	1132	1033	889	734	519

# Hydraulically-Driven, Cast Iron with ForceField Technology

## Series 9307CWS



### For Flanged Connections You Will Also Need:

- Universal Flange Gasket
- Universal Flange Clamp

See page 252 for details

### Order Information

Model Number	Max GPM	Max LPM	Max PSI	Max BAR	Max Hyd. GPM	Max Hyd. LPM	Hydraulic Selection System
9307CWS-GM12	370	1400	135	9.8	23	87.1	Open/Closed

- ForceField seal technology to protect your pump against today's harshest application environments:
  - Eliminates dry run failures
  - Eliminates chemical and fertilizer bonding failures
  - Prevents costly in-season downtime
  - Maintenance-free operation
  - Self-regulating chamber designed to provide pressure when needed and safe serviceability when it is not needed
  - Direct drop-in for current 9307 designs
- Components designed for today's high volume liquid fertilizer application on large capacity sprayers:
  - Hydraulic motor includes a case drain for maximum motor life
  - 316 stainless steel impeller
  - Two-piece shaft design includes 416 stainless steel wet end and 8620 hardened steel drive end
  - Bearings designed to handle continuous high volume pump loading
- Capable of flows over 370 GPM (1400 LPM) at 40 PSI (2.8 BAR)
- 300 universal flange inlet x 220 universal flange outlet
- One-year warranty that includes pump, motor and seals



### 9307CWS-GM12: Performance in water

#### U.S. Units

Hyd. Flow GPM	GPM at 30 PSI	GPM at 40 PSI	GPM at 50 PSI	GPM at 60 PSI	GPM at 70 PSI	GPM at 80 PSI	GPM at 90 PSI	GPM at 100 PSI	GPM at 110 PSI
16	222	180	115						
17	246	212	166	92					
18	274	245	209	157	58				
19	302	272	242	203	150				
20	326	298	271	240	196	142			
21	345	324	297	269	238	194	140		
22	345	345	322	297	270	236	193	138	
23	370	370	344	323	299	273	235	194	137

### 9307CWS-GM12: Performance in water

#### Metric Units

Hyd. Flow LPM	LPM at 2.1 BAR	LPM at 2.8 BAR	LPM at 3.4 BAR	LPM at 4.1 BAR	LPM at 4.8 BAR	LPM at 5.5 BAR	LPM at 6.2 BAR	LPM at 6.9 BAR	LPM at 7.6 BAR
60.6	840	681	435						
64.4	931	802	628	348					
68.1	1037	927	791	594	220				
71.9	1143	1030	916	768	568				
75.7	1234	1128	1026	908	742	537			
79.5	1306	1226	1124	1018	901	734	530		
83.3	1306	1306	1219	1124	1022	893	731	522	
87.1	1400	1400	1302	1223	1132	1033	889	734	519

### 9307CWS-GM12: Performance in 28% liquid fertilizer

#### U.S. Units

Hyd. Flow GPM	GPM at 40 PSI	GPM at 50 PSI	GPM at 60 PSI	GPM at 70 PSI	GPM at 80 PSI	GPM at 90 PSI	GPM at 100 PSI	GPM at 110 PSI	GPM at 120 PSI	GPM at 130 PSI	GPM at 140 PSI
16	228	204	159	100							
17	234	219	190	147	49						
18	247	247	223	194	146	49					
19	255	255	239	221	191	151	55				
20	260	260	252	240	220	191	150	63			
21	260	260	254	248	237	224	196	159	87		
22	260	260	254	248	240	230	214	194	159	101	
23	260	260	254	249	249	242	237	227	211	174	133

### 9307CWS-GM12: Performance in 28% liquid fertilizer

#### Metric Units

Hyd. Flow LPM	LPM at 2.8 BAR	LPM at 3.4 BAR	LPM at 4.1 BAR	LPM at 4.8 BAR	LPM at 5.5 BAR	LPM at 6.2 BAR	LPM at 6.9 BAR	LPM at 7.6 BAR	LPM at 8.3 BAR	LPM at 9.0 BAR	LPM at 9.7 BAR
60.6	863	772	602	379	-						
64.4	886	829	719	556	185						
68.1	935	935	844	734	553	185					
71.9	965	965	905	836	723	572	208				
75.7	984	984	954	908	833	723	568	238			
79.5	984	984	961	939	897	848	742	602	329		
83.3	984	984	961	939	908	871	810	734	602	382	
87.1	984	984	961	942	942	916	897	859	799	659	503

# Hydraulically-Driven, Cast Iron

## Series 9308C



### Features

- 5" ANSI-flanged inlet x 4" ANSI-flanged outlet
- 316 stainless steel impeller for superior corrosion resistance
- 9308 versions include a two-piece shaft design with a 416 stainless steel wet end and hardened 8620 drive end for extended life
- Life Guard silicon carbide seal for premium abrasion resistance and dry-run protection
- Life Guard seals are the industry standard on OEM equipment

### Order Information

Model Number	Max GPM	Max LPM	Max PSI	Max BAR	Max Hyd GPM	Max Hyd LPM	Hydraulic Selection System
9308C-PM15	900	3407	58	4.0	16	60.6	Open/Closed
9308C-GM25	1078	4081	72	5.0	28	106	Open/Closed
9308CX	Pump head only						
3430-0604	Life Guard silicon carbide seal kit						

### 9308C-PM15

#### U.S. Units

Hyd. Flow GPM	GPM at 10 PSI	GPM at 20 PSI	GPM at 30 PSI	GPM at 40 PSI	GPM at 50 PSI
8	430				
12	656	656	416		
16	900	900	900	778	607

### 9308C-PM15

#### Metric Units

Hyd. Flow LPM	LPM at 0.7 BAR	LPM at 1.4 BAR	LPM at 2.1 BAR	LPM at 2.8 BAR	LPM at 3.5 BAR
30.3	1628				
45.7	2483	2483	1575		
60.6	3407	3407	3407	2945	2298

### 9308C-GM25

#### U.S. Units

Hyd. Flow GPM	GPM at 20 PSI	GPM at 30 PSI	GPM at 40 PSI	GPM at 50 PSI	GPM at 60 PSI	GPM at 70 PSI
17	520					
23	828	828	667	296		
28	1078	1078	965	845	667	380

### 9308C-GM25

#### Metric Units

Hyd. Flow LPM	LPM at 1.4 BAR	LPM at 2.1 BAR	LPM at 2.8 BAR	LPM at 3.5 BAR	LPM at 4.1 BAR	LPM at 4.8 BAR
64.3	1968					
87.1	3134	3134	2525	1120		
106	4081	4081	3653	3199	2525	1438

# Belt-Driven, Cast Iron, Self-Priming

## Series 9400C-SP



### Upgrade Options:

- Increase dry-run and abrasive resistance with Life Guard Seals
  - Life Guard seals are the OEM standard

### Features

- Drive: 12-groove belt
- Spring-loaded belt tensioner
- Stainless steel wear ring
- Stainless steel pump shaft, standard
- Port sizes: 1-1/2" NPT inlet, 1-1/4" NPT outlet
- Max. fluid temperature: 140°F/60°C
- Housing: Cast iron
- Impeller: Nylon
- Pump shaft rotation: Counter clockwise when looking at shaft end
- Pump seals: Viton®/ceramic standard; Life Guard silicon carbide (B) available
- Life Guard seals are the industry standard on OEM equipment
- Weight: 57 lbs./25.9 kg

### Order Information

Model Number	Max GPM	Max LPM	Max PSI	Max BAR	Max RPM	PTO Output
9403C-540-SP	120	454	99	6.8	600	1-3/8" female, 6 spline shaft
9403C-540Q-SP	120	454	99	6.8	600	1-3/8" 6 spline quick coupler
9403C-540S-SP	120	454	99	6.8	600	1" [25.4 mm] solid shaft
9403C-1000-SP	120	454	99	6.8	1000	1-3/8" female, 21-spline shaft
9403C-1000L-SP	120	454	99	6.8	1000	1-3/4" female, 20-spline shaft
3430-0332	Seal kit standard					
3430-0589	Life Guard silicon carbide seal kit					
3430-0480SP	Self priming chamber kit					

Life Guard silicon carbide seal - Add suffix "B" (i.e.: 9403C-540-SP-B)

### 9403C-540-SP

#### U.S. Units

RPM	GPM at 10 PSI	GPM at 20 PSI	GPM at 30 PSI	GPM at 40 PSI	GPM at 50 PSI	GPM at 60 PSI	GPM at 70 PSI	GPM at 80 PSI	GPM at 90 PSI
500	114	113	101	83	60	27			
540	120	119	116	102	85	62	32		
600	120	120	120	119	110	97	78	54	24

### 9403C-540-SP

#### Metric Units

RPM	LPM at 0.7 BAR	LPM at 1.4 BAR	LPM at 2.1 BAR	LPM at 2.8 BAR	LPM at 3.4 BAR	LPM at 4.1 BAR	LPM at 4.8 BAR	LPM at 5.5 BAR	LPM at 6.2 BAR
500	432	428	382	314	227	102			
540	454	450	439	386	322	235	121		
600	454	454	454	450	416	367	295	204	91

### 9403C-1000-SP

#### U.S. Units

RPM	GPM at 10 PSI	GPM at 20 PSI	GPM at 30 PSI	GPM at 40 PSI	GPM at 50 PSI	GPM at 60 PSI	GPM at 70 PSI	GPM at 80 PSI	GPM at 90 PSI
800	111	109	94	74	47	21			
900	120	119	116	102	85	62	32		
1000	120	120	120	119	110	97	78	54	24

### 9403C-1000-SP

#### Metric Units

RPM	LPM at 0.7 BAR	LPM at 1.4 BAR	LPM at 2.1 BAR	LPM at 2.8 BAR	LPM at 3.4 BAR	LPM at 4.1 BAR	LPM at 4.8 BAR	LPM at 5.5 BAR	LPM at 6.2 BAR
800	420	413	356	280	178	79			
900	454	450	439	386	322	235	121		
1000	454	454	454	450	416	367	295	204	91

Viton® is a registered trademark of DuPont. Hypro® is a registered trademark of Pentair.

# Belt-Driven, Cast Iron, Polypropylene & Stainless Steel

## Series 9400 Belt Drive



### Upgrade Options:

- Increase dry-run and abrasive resistance with Life Guard Seals
  - Life Guard seals are the OEM standard
- Extend pump life with Stainless Steel
  - Fact: Chemical corrosion, pump cavitation, and abrasive wear are key factors in pump life
  - 316 Stainless Steel pumps provide superior chemical corrosion resistance, while maintaining material strength to prolong the life against abrasive wear
  - 316 Stainless Steel resists cavitation pitting of pumps, extending the wear life
  - Drop in replacements for cast iron pumps

### Features

- Available in cast iron, polypropylene and 316 stainless steel for extended pump life
- Drive: 12-groove belt
- Spring-loaded belt tensioner
- Stainless steel wear ring
- Stainless steel pump shaft, standard
- Port sizes: 9402 models – 1-1/4" NPT inlet, 1" NPT outlet; 9403 models – 1-1/2" NPT inlet, 1-1/4" NPT outlet
- 220 x 200 universal flange available (U)
- Max. fluid temperature: 140°F/60°C
- Impeller: Cast Iron models – Nylon; Poly & Stainless Steel models – Polypropylene
- Pump shaft rotation: Counter clockwise when looking at shaft end
- Pump seals: Viton®/ceramic standard; Life Guard silicon carbide (B) available
- Life Guard seals are the industry standard on OEM equipment
- Weight: 40-45 lbs./18.2-20.5 kg

### For Flanged Connections You Will Also Need:

- Universal Flange Gasket     Universal Flange Clamp

See page 252 for details

### Order Information

Model Number	Max GPM	Max LPM	Max PSI	Max BAR	Max RPM	PTO Output
9402C-540	76	283	95	6.5	600	1-3/8" female, 6-spline shaft
9402C-540Q	76	283	95	6.5	600	1-3/8" 6-spline quick coupler
9402C-540S	76	283	95	6.5	600	1" [25.4 mm] solid shaft
9402C-1000	76	283	95	6.5	1000	1-3/8" female, 21-spline shaft
9402C-1000L	76	283	95	6.5	1000	1-3/4" female, 20-spline shaft
9402C-1000S	76	283	95	6.5	1000	1" [25.4 mm] solid shaft
9403C-540†	140	530	104	7.2	600	1-3/8" female, 6-spline shaft
9403C-540Q†	140	530	104	7.2	600	1-3/8" 6-spline quick coupler
9403C-540S†	140	530	104	7.2	600	1" [25.4 mm] solid shaft
9403C-1000†	140	530	104	7.2	1000	1-3/8" female, 21-spline shaft
9403C-1000L†	140	530	104	7.2	1000	1-3/4" female, 20-spline shaft
9403C-1000-MTZ*	164	617	113	7.8	1000	38 mm female, 8-spline shaft
9403C-1000-MTZ-KIT*	Includes pump, Anti-rotation Kit and Vent Line kit					
9403C-1000S†	140	530	104	7.2	1000	1" [25.4 mm] solid shaft
9403P-540	91	344	83	5.7	600	1-3/8" female, 6-spline shaft
9403P-540Q	91	344	83	5.7	600	1-3/8" 6-spline quick coupler
9403P-540S	91	344	83	5.7	600	1" [25.4 mm] solid shaft
9403P-1000	86	326	83	5.7	1000	1-3/8" female, 21-spline shaft
9403P-1000L	86	326	83	5.7	1000	1-3/4" female, 20-spline shaft
9403P-1000S	86	326	83	5.7	1000	1" [25.4 mm] solid shaft
9403S-540	140	530	104	7.2	540	1-3/8" female, 6-spline shaft
9403S-540Q	140	530	104	7.2	540	1-3/8" 6-spline quick coupler
9403S-540S	140	530	104	7.2	540	1" [25.4 mm] solid shaft
9403S-1000	140	530	104	7.2	1000	1-3/8" female, 21-spline shaft
9403S-1000L	140	530	104	7.2	1000	1-3/4" female, 20-spline shaft
9403S-1000S	140	530	104	7.2	1000	1" [25.4 mm] solid shaft
3430-0332	Seal and o-ring repair kit					
3430-0476	Seal, o-ring, belt and gasket repair kit for 540 rpm drives					
3430-0477	Seal, o-ring, belt and gasket repair kit for 1000 rpm drives					
3430-0589	Life Guard silicon carbide seal kit					
3430-0333	Seal and o-ring repair kit (polypropylene)					
3430-0478	Seal, o-ring, belt and gasket repair kit for 540 rpm drives (polypropylene)					
3430-0479	Seal, o-ring, belt and gasket repair kit for 1000 rpm drives (polypropylene)					
3430-0590	Life Guard silicon carbide seal kit (polypropylene)					
3430-0796*	Anti-Rotation Kit for MTZ pump					

†Universal Flange (220 x 200) - Add Suffix "U" (i.e.: 9403C-1000S-U)

Life Guard silicon carbide seal - Add suffix "B" (i.e.: 9402C-540-B)

Available for order through Hypro-EU only (Cambridge, UK)

Viton® is a registered trademark of DuPont. Hypro® is a registered trademark of Pentair.

\* For tractors MTZ 80 and 82.

**9402C-540 U.S. Units**

RPM	GPM at 20 PSI	GPM at 30 PSI	GPM at 40 PSI	GPM at 50 PSI	GPM at 60 PSI	GPM at 70 PSI	GPM at 80 PSI	GPM at 90 PSI
450	61	58	50	36				
500	67	66	62	56	42			
540	71	71	70	65	58	44		
600	76	76	76	75	73	66	56	42

**9402C-540 Metric Units**

RPM	LPM at 1.4 BAR	LPM at 2.1 BAR	LPM at 2.8 BAR	LPM at 3.4 BAR	LPM at 4.1 BAR	LPM at 4.8 BAR	LPM at 5.5 BAR	LPM at 6.2 BAR
450	231	220	189	136				
500	254	250	235	212	159			
540	269	269	265	246	220	167		
600	288	288	288	284	276	250	212	159

**9402C-1000 U.S. Units**

RPM	GPM at 20 PSI	GPM at 30 PSI	GPM at 40 PSI	GPM at 50 PSI	GPM at 60 PSI	GPM at 70 PSI	GPM at 80 PSI	GPM at 90 PSI	GPM at 100 PSI
800	68	67	64	57	41				
900	74	74	73	71	64	54	41		
1000	76	76	76	76	76	72	65	56	43

**9402C-1000 Metric Units**

RPM	LPM at 1.4 BAR	LPM at 2.1 BAR	LPM at 2.8 BAR	LPM at 3.4 BAR	LPM at 4.1 BAR	LPM at 4.8 BAR	LPM at 5.5 BAR	LPM at 6.2 BAR	LPM at 6.9 BAR
800	257	254	242	216	155				
900	280	280	276	269	242	204	155		
1000	288	288	288	288	288	273	246	212	163

**9403C-540, 9403S-540 U.S. Units**

RPM	GPM at 20 PSI	GPM at 30 PSI	GPM at 40 PSI	GPM at 50 PSI	GPM at 60 PSI	GPM at 70 PSI	GPM at 80 PSI	GPM at 90 PSI	GPM at 100 PSI
450	107	99	86	50					
500	121	116	106	93	76	42			
540	129	127	120	111	98	80	50		
600	140	138	135	130	121	112	94	73	40

**9403C-540, 9403S-540 Metric Units**

RPM	LPM at 1.4 BAR	LPM at 2.1 BAR	LPM at 2.8 BAR	LPM at 3.4 BAR	LPM at 4.1 BAR	LPM at 4.8 BAR	LPM at 5.5 BAR	LPM at 6.2 BAR	LPM at 6.9 BAR
450	405	375	326	189					
500	458	439	401	352	288	159			
540	488	481	454	420	371	303	189		
600	530	522	511	492	458	424	356	276	151

**9403C-1000, 9403S-1000 U.S. Units**

RPM	GPM at 20 PSI	GPM at 30 PSI	GPM at 40 PSI	GPM at 50 PSI	GPM at 60 PSI	GPM at 70 PSI	GPM at 80 PSI	GPM at 90 PSI	GPM at 100 PSI
800	115	106	96	80	56				
900	129	127	120	111	98	80	50		
1000	140	139	137	133	128	119	100	76	46

**9403C-1000, 9403S-1000 Metric Units**

RPM	LPM at 1.4 BAR	LPM at 2.1 BAR	LPM at 2.8 BAR	LPM at 3.4 BAR	LPM at 4.1 BAR	LPM at 4.8 BAR	LPM at 5.5 BAR	LPM at 6.2 BAR	LPM at 6.9 BAR
800	435	401	363	303	212				
900	488	481	454	420	371	303	189		
1000	530	526	519	503	485	450	379	288	174

**9403C-1000-MTZ U.S. Units**

RPM	GPM at 10 PSI	GPM at 20 PSI	GPM at 30 PSI	GPM at 40 PSI	GPM at 50 PSI	GPM at 60 PSI	GPM at 70 PSI	GPM at 80 PSI	GPM at 90 PSI	GPM at 100 PSI	GPM at 110 PSI
800	136	132	123	112	98	70	45				
900	150	149	145	135	125	115	97	72	35		
1000	163	162	160	155	150	140	130	115	95	75	45

**9403C-1000-MTZ Metric Units**

RPM	LPM at 0.7 Bar	LPM at 1.4 Bar	LPM at 2.1 Bar	LPM at 2.8 Bar	LPM at 3.4 Bar	LPM at 4.1 Bar	LPM at 4.8 Bar	LPM at 5.5 Bar	LPM at 6.2 Bar	LPM at 6.9 Bar	LPM at 7.6 Bar
800	515	500	466	424	371	265	170				
900	568	564	549	511	473	435	367	273	132		
1000	617	613	606	587	568	530	492	435	360	284	170

# Gas Engine-Driven PowerPro, Cast Iron

Models 1521C-65, 1521C-65M



## Upgrade Options:

- Increase dry-run and abrasive resistance with Life Guard Seals
  - Life Guard seals are the OEM standard

## Features

- PowerPro Engine (EPA & CARB certified)
- Closed coupled, gas engine-driven
- Max. fluid temperature: 140°F/60°C
- Housing: cast iron
- Impeller: Nylon
- Pump seals: Viton®/ceramic standard; Life Guard silicon carbide available
- Life Guard seals are the industry standard on OEM equipment
- Weight: 65 lbs./29.4kg

## Order Information

Model Number	Max GPM	Max LPM	Max PSI	Max BAR	Port Size	Engine Mfr. & HP
1521C-65	110	416	80	5.5	1-1/2" x 1-1/4"	PowerPro 6.5 hp
1521C-65M	Same as 1521C-65 with mounting base					
1538	1-1/2" x 1-1/4" centrifugal pump. DOES NOT include Engine. (Must use 5/8" threaded shaft engine)					
3430-0332	Seal and o-ring repair kit					
3430-0589	Life Guard silicon carbide seal kit					

### 1521C-65, 1521C-65M

### U.S. Units

GPM at 10 PSI	GPM at 20 PSI	GPM at 30 PSI	GPM at 40 PSI	GPM at 50 PSI	GPM at 60 PSI	GPM at 70 PSI
110	106	96	88	80	60	30

### 1521C-65, 1521C-65M

### Metric Units

LPM at 0.7 BAR	LPM at 1.4 BAR	LPM at 2.1 BAR	LPM at 2.8 BAR	LPM at 3.4 BAR	LPM at 4.1 BAR	LPM at 4.8 BAR
416	401	363	333	303	227	114

# Gas Engine-Driven PowerPro, Cast Iron

Models 1552C-130, 1522C-130E



## Features

- PowerPro Engine (EPA & CARB certified)
- Closed coupled, gas engine-driven
- Max. fluid temperature: 140°F/60°C
- Housing: cast iron
- Impeller: Nylon
- Pump seals: Viton®/ceramic standard
- Weight: 110 lbs./50kg

## Order Information

Model Number	Max GPM	Max (LPM)	Max PSI	Max BAR	Port Size	Engine Mfr. & HP
1552C-130	170	644	150	10.3	2" x 1-1/2"	PowerPro 13 hp
1552C-130E	170	644	150	10.3	2" x 1-1/2"	PowerPro 13 hp w/ electric start
1551	2" x 1-1/2" centrifugal pump kit. DOES NOT include engine. (Must use 1" threaded shaft engine)					
3430-0464	Seal and o-ring repair kit					

### 1552C-130, 1552C-130E

### U.S. Units

GPM at 20 PSI	GPM at 40 PSI	GPM at 60 PSI	GPM at 80 PSI	GPM at 100 PSI	GPM at 120 PSI	GPM at 140 PSI
170	166	148	120	92	65	35

### 1552C-130, 1552C-130E

### Metric Units

LPM at 1.4 BAR	LPM at 2.8 BAR	LPM at 4.1 BAR	LPM at 5.5 BAR	LPM at 6.9 BAR	LPM at 8.3 BAR	LPM at 9.7 BAR
644	628	560	454	348	246	132



# Gas Engine-Driven PowerPro, Cast Iron, Self-Priming

Models 1522C-65SP



## Upgrade Options:

- Increase dry-run and abrasive resistance with Life Guard Seals
  - Life Guard seals are the OEM standard

## Features

- PowerPro Engine (EPA & CARB certified)
- Closed coupled, gas engine-driven
- Max. fluid temperature: 140°F/60°C
- Housing: cast iron
- Impeller: Nylon
- Pump seals: Viton®/ceramic standard; Life Guard silicon carbide available
- Life Guard seals are the industry standard on OEM equipment
- Fill Port 3/4" NPT

## Order Information

Model Number	Max GPM	Max LPM	Max PSI	Max BAR	Port Size	Engine Mfg. & HP
1522C-65SP	130	492	65	4.5	2" x 2"	PowerPro 6.5 hp
1538-SP*	2" x 2" centrifugal pump kit. does not include engine.					
3430-0332	Seal and o-ring repair kit					
3430-0589	Life Guard silicon carbide seal kit					

\* Must use threaded-shaft engine.

## 1522C-65SP

## U.S. Units

GPM at 0 PSI	GPM at 10 PSI	GPM at 20 PSI	GPM at 30 PSI	GPM at 35 PSI	GPM at 40 PSI	GPM at 50 PSI	GPM at 60 PSI	GPM at 65 PSI
130	121	108	93	85	76	56	34	0

## 1522C-65SP

## Metric Units

LPM at 0 BAR	LPM at 0.7 BAR	LPM at 1.4 BAR	LPM at 2.1 BAR	LPM at 2.4 BAR	LPM at 2.8 BAR	LPM at 3.4 BAR	LPM at 4.1 BAR	LPM at 4.5 BAR
492	458	409	352	322	288	212	129	0

# Gas Engine-Driven PowerPro, Cast Iron, Self-Priming

Models 1552C-130SP, 1552C-130ESP



## Features

- PowerPro Engine (EPA & CARB certified)
- Closed coupled, gas engine-driven
- Max. fluid temperature: 140°F/60°C
- Housing: cast iron
- Impeller: Nylon
- Pump seals: Viton®/ceramic standard
- Fill Port 1" NPT

## Order Information

Model Number	Max GPM	Max LPM	Max PSI	Max BAR	Port Size	Engine Mfg. & HP
1552C-130SP	163	617	147	10.1	2" x 2"	PowerPro 13 hp
1552C-130ESP	163	617	147	10.1	2" x 2"	PowerPro 13 hp w/ electric start
1551-SP*	2" x 2" centrifugal pump kit. Does not include engine.					
1551-BSP*	2" x 2" centrifugal pump kit. (BSP threads) Does not include engine.					
3430-0464	Seal and o-ring repair kit					

\* Must use threaded-shaft engine.

## 1552C-130SP, 1552C-130ESP

## U.S. Units

GPM at 0 PSI	GPM at 20 PSI	GPM at 40 PSI	GPM at 60 PSI	GPM at 80 PSI	GPM at 100 PSI	GPM at 120 PSI	GPM at 140 PSI	GPM at 147 PSI
163	161	148	122	100	75	51	27	0

## 1552C-130SP, 1552C-130ESP

## Metric Units

LPM at 0 BAR	LPM at 1.4 BAR	LPM at 12.8 BAR	LPM at 4.1 BAR	LPM at 5.5 BAR	LPM at 6.9 BAR	LPM at 8.3 BAR	LPM at 9.7 BAR	LPM at 10.1 BAR
617	609	560	462	379	284	193	102	0

Viton® is a registered trademark of DuPont. Hypro® is a registered trademark of Pentair.

# Gas Engine-Driven, Cast Iron

## Models 1536 and 1539



### Upgrade Options:

- Increase dry-run and abrasive resistance with Life Guard Seals
  - Life Guard seals are the OEM standard

### Features

- Briggs & Stratton® engine (EPA & CARB certified)
- Close-coupled, gas engine-driven
- Max. fluid temperature: 140°F/60°C
- Housing: cast iron
- Impeller: Nylon
- Pump seals: Viton®/ceramic standard; Life Guard silicon carbide available
- Life Guard seals are the industry standard on OEM equipment
- Weight: 53 lbs./24.1 kg

### Order Information

Model Number	Max GPM	Max LPM	Max PSI	Max BAR	Port Size	Engine Mfg. & HP
1536	110	416	75	5.2	1-1/2" x 1-1/4"	Briggs & Stratton® 5.5 hp
1539	Same as model 1536 without mounting base					
1538*	1-1/2" x 1-1/4" centrifugal pump kit. DOES NOT include engine.					
3430-0332	Seal and o-ring repair kit					
3430-0589	Life Guard silicon carbide seal kit					

\* Must use threaded shaft engine.

### 1536, 1539

### U.S. Units

GPM at 10 PSI	GPM at 20 PSI	GPM at 30 PSI	GPM at 40 PSI	GPM at 50 PSI	GPM at 60 PSI
110	106	96	87	73	50

### 1536, 1539

### Metric Units

LPM at 0.7 BAR	LPM at 1.4 BAR	LPM at 2.1 BAR	LPM at 2.8 BAR	LPM at 3.4 BAR	LPM at 4.1 BAR
416	401	363	329	276	189

Briggs & Stratton® is a registered trademark of Briggs & Stratton Corporation.

# Gas Engine-Driven, Cast Iron

## Models 1537 and 1540



### Upgrade Options:

- Increase dry-run and abrasive resistance with Life Guard Seals
  - Life Guard seals are the OEM standard

### Features

- Honda® engine (EPA & CARB certified)
- Close-coupled, gas engine-driven
- Max. fluid temperature: 140°F/60°C
- Housing: cast iron
- Impeller: Nylon
- Pump seals: Viton®/ceramic standard; Life Guard silicon carbide available
- Life Guard seals are the industry standard on OEM equipment
- Weight: 53 lbs./24.1 kg

### Order Information

Model Number	Max GPM	Max LPM	Max PSI	Max BAR	Port Size	Engine Mfg. & HP
1537	110	416	80	5.5	1-1/2" x 1-1/4"	Honda® 5.5 hp
1540	Same as model 1537 without mounting base					
1538*	1-1/2" x 1-1/4" centrifugal pump kit. DOES NOT include engine.					
3430-0332	Seal and o-ring repair kit					
3420-0589	Life Guard silicon carbide seal kit					

\* Must use threaded shaft engine.

### 1537, 1540

### U.S. Units

GPM at 10 PSI	GPM at 20 PSI	GPM at 30 PSI	GPM at 40 PSI	GPM at 50 PSI	GPM at 60 PSI	GPM at 70 PSI
110	106	96	88	80	60	30

### 1537, 1540

### Metric Units

LPM at 0.7 BAR	LPM at 1.4 BAR	LPM at 2.1 BAR	LPM at 2.8 BAR	LPM at 3.4 BAR	LPM at 4.1 BAR	LPM at 4.8 BAR
416	401	363	333	303	227	114

Honda® is a registered trademark of Honda Motor Co., Ltd.  
Hypro is a registered trademark of Pentair Ltd.

# Gas Engine-Driven, Cast Iron, Self-Priming

Models 1536-SP and 1539-SP



## Upgrade Options:

- Increase dry-run and abrasive resistance with Life Guard Seals
  - Life Guard seals are the OEM standard

## Features

- Briggs & Stratton® engine (EPA & CARB certified)
- Max. fluid temperature: 140°F/60°C
- Housing: cast iron
- Impeller: Nylon
- Pump seals: Viton®/ceramic standard; Life Guard silicon carbide available
- Life Guard seals are the industry standard on OEM equipment
- Fill Port 3/4" NPT
- Weight: 72 lbs./32.7 kg

## Order Information

Model Number	Max GPM	Max LPM	Max PSI	Max BAR	Port Size	Engine Mfr. & HP
1536-SP	100	379	65	4.5	2" x 2"	Briggs & Stratton® 5.5 hp
1539-SP	Same as model 1536-SP without mounting base					
1538-SP*	2" x 2" centrifugal pump kit. DOES NOT include engine.					
3430-0332	Seal kit standard					
3430-04825P	Self-primer conversion kit					
3430-0589	Life Guard silicon carbide seal kit					

\* Must use threaded shaft engine.

### 1536-SP, 1539-SP

### U.S. Units

GPM at 10 PSI	GPM at 20 PSI	GPM at 30 PSI	GPM at 40 PSI	GPM at 50 PSI	GPM at 60 PSI
92	81	67	55	40	15

### 1536-SP, 1539-SP

### Metric Units

LPM at 0.7 BAR	LPM at 1.4 BAR	LPM at 2.1 BAR	LPM at 2.8 BAR	LPM at 3.4 BAR	LPM at 4.1 BAR
348	307	254	208	151	57

Briggs & Stratton® is a registered trademark of Briggs & Stratton Corporation.

# Gas Engine-Driven, Cast Iron, Self-Priming

Models 1537-SP and 1540-SP



## Upgrade Options:

- Increase dry-run and abrasive resistance with Life Guard Seals
  - Life Guard seals are the OEM standard

## Features

- Honda® engine (EPA & CARB certified)
- Max. fluid temperature: 140°F/60°C
- Housing: cast iron
- Impeller: Nylon
- Pump seals: Viton®/ceramic standard; Life Guard silicon carbide available
- Life Guard seals are the industry standard on OEM equipment
- Fill Port 3/4" NPT
- Weight: 78 lbs./35 kg

## Order Information

Model Number	Max GPM	Max LPM	Max PSI	Max BAR	Port Size	Engine Mfr. & HP
1537-SP	106	401	75	5.2	2" x 2"	Honda® 5.5 hp
1540-SP	Same as model 1537-SP without mounting base					
1538-SP*	2" x 2" centrifugal pump kit. DOES NOT include engine.					
3430-0332	Seal kit standard					
3430-04825P	Self-primer conversion kit					
3430-0589	Life Guard silicon carbide seal kit					

\* Must use threaded shaft engine.

### 1537-SP, 1540-SP

### U.S. Units

GPM at 10 PSI	GPM at 20 PSI	GPM at 30 PSI	GPM at 40 PSI	GPM at 50 PSI	GPM at 60 PSI
98	87	73	60	44	21

### 1537-SP, 1540-SP

### Metric Units

LPM at 0.7 BAR	LPM at 1.4 BAR	LPM at 2.1 BAR	LPM at 2.8 BAR	LPM at 3.4 BAR	LPM at 4.1 BAR
371	329	276	227	167	79

Viton® is a registered trademark of DuPont.

Honda® is a registered trademark of Honda Motor Co., Ltd.  
Hypro is a registered trademark of Pentair.

# Gas Engine-Driven, Cast Iron

## Series 1550



- Honda® engine (EPA & CARB certified)
- Close-coupled, gas engine-driven
- Max. fluid temperature: 140°F/60°C
- Housing: cast iron
- Pump seals: Viton®/ceramic
- Impeller: Nylon
- Weight: 105 lbs./47.7 kg; SP and BSP: 125 lbs./56.8 kg

### Order Information

Model Number	Max GPM	Max LPM	Max PSI	Max BAR	Port Size	Engine Mfgr. & HP	Self Priming
1550	150	568	140	9.7	2" x 1-1/2"	Honda® 9 hp	No
1550-SP	155	587	135	9.3	2" x 2"	Honda® 9 hp	Yes
1550-BSP†	155	587	135	9.3	2" x 2"	Honda® 9 hp	Yes
1551*	2" x 1-1/2" centrifugal pump kit. DOES NOT include engine.						
1551-SP*	2" x 2" centrifugal pump kit. DOES NOT include engine.						
3430-0464	Seal, o-ring, and gasket repair kit						
3430-0779	Life Guard silicon carbide seal kit						

\* Must use threaded shaft engine. † BSP Threads

### 1550 U.S. Units

GPM at 20 PSI	GPM at 40 PSI	GPM at 60 PSI	GPM at 80 PSI	GPM at 100 PSI	GPM at 120 PSI	GPM at 140 PSI
145	130	107	87	69	45	16

### 1550-SP, 1550-BSP U.S. Units

GPM at 10 PSI	GPM at 20 PSI	GPM at 40 PSI	GPM at 60 PSI	GPM at 80 PSI	GPM at 100 PSI	GPM at 120 PSI
145	141	118	93	71	49	28

### 1550 Metric Units

LPM at 1.4 BAR	LPM at 2.8 BAR	LPM at 4.1 BAR	LPM at 5.5 BAR	LPM at 6.9 BAR	LPM at 8.3 BAR	LPM at 9.7 BAR
549	492	405	329	261	170	61

### 1550-SP, 1550-BSP Metric Units

LPM at 0.7 BAR	LPM at 1.4 BAR	LPM at 2.1 BAR	LPM at 2.8 BAR	LPM at 3.4 BAR	LPM at 4.1 BAR	LPM at 4.8 BAR
549	534	447	352	269	185	106

Viton® is a registered trademark of DuPont.

Honda® is a registered trademark of Honda Motor Co., Ltd.  
Hypro is a registered trademark of Pentair.

# Understanding Mechanical Seal Options

## Standard

Industry tested and proven



### Common Uses:

Less demanding applications; minimal dry run or abrasive solution

**Material:** Carbon on Ceramic

**How it Works:** Mechanical seals depend on their seal face conditions of flatness and finish to maintain their sealing function while allowing the shaft to rotate. A spring ensures the seal faces stay in contact to prevent leaking. Elastomers are mated with adjacent shaft and housing components to complete the sealing system.

### Pro:

- Dependable life when protected
- from dry run and abrasives
- Least expensive option

### Con:

- Minimal dry run resistance
- Limited service life in abrasive solutions
- Susceptible to chemical & fertilizer bonding failures

## Life Guard

The OEM standard



### Common Uses:

Suited for broad spraying applications including abrasive solutions

**Material:** Silicon Carbide

**Advantages over Standard:** The hardness of Silicon Carbide approaches that of diamond and allows the seal to have outstanding service life when pumping abrasive solutions. Carbon graphite flakes are embedded into the silicon carbide faces to increase lubricity and provide survivability against incidental dry run and thermal shock.

### Pro:

- Extended service life in abrasive solutions
- Enhanced dry run resistance
- Drop-in replacement for standard seal

### Con:

- Does not eliminate dry run failure
- Susceptible to chemical & fertilizer bonding failures
- Increased cost

## ForceField Technology

The premium choice



### Common Uses:

Applications where downtime must be avoided.

**Material:** Carbon on Silicon

**Advantages over Life Guard:** ForceField wet seal technology protects seals by using a barrier fluid to keep them cool and lubricated, even while the pump is running dry. ForceField technology actively maintains a positive pressure differential between the chamber barrier fluid and the pumping solution, which prevents chemical bonding of the seal faces. The result is increased life and maintenance free operation.

### Pro:

- Eliminates dry run failure
- Prevents chemical & fertilizer bonding failures
- Maintenance-free operation
- Warranted for one full year

### Con:

- Not a drop-in replacement for standard or Life Guard seals
- Increased cost

# Life Guard Silicon Carbide Pump Seals

Specially designed to prolong seal life



## Side by Side Comparison

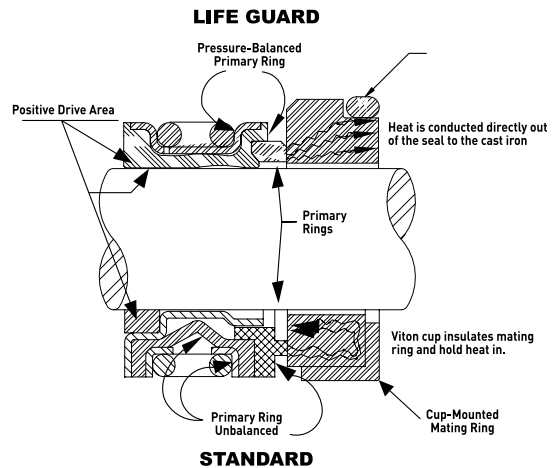

The drawing to the right represents a cross sectional view of a Life Guard Premium Silicon Carbide Seal (top) and a standard seal (bottom). There are three key differences shown in the drawing: material, mating rings and balance.

### Material:

The Life Guard seal utilizes silicon carbide (SiC) for its seal surfaces (primary ring and mating ring). This is more abrasion resistant than the carbon graphite and ceramic used in standard seals. SiC also runs cooler if the pump is run dry, improving the life of the seal.

### Mating Rings:

The O-ring style of the Life Guard seal mating ring allows heat to dissipate into the pump casting. This keeps the seal at a lower temperature and dramatically improves the chances of the seal to survive a dry-run episode.

### Balance:

The bellows and primary ring of the Life Guard seal are pressure balanced. This results in cooler operation at higher pressures.

Life Guard silicon carbide seals are available in the following models: Pedestal mount, Flange mount, Clutch-driven, Hydraulically-driven, Belt-driven, and Gas Engine-driven.

### LIFE TEST IN ABRASIVE SOLUTION

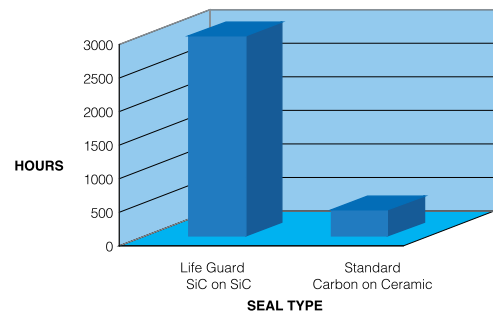

### DRY-RUN SURVIVABILITY (5 MINUTES/CYCLE)

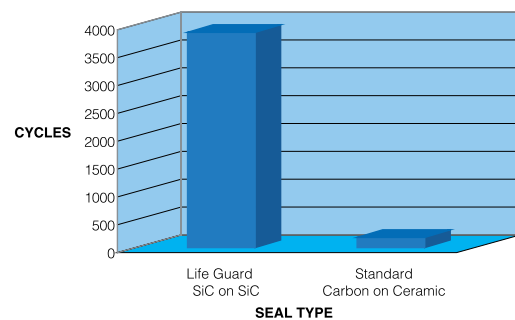

## Life Guard Silicon Carbide Seal Kits

Part Number	Pump Series/Model #	Size		Description	Estimated Weight Ea.
		US	Metric		
3430-0589	9200, 9300 and 9400 Cast and Stainless	5/8"	15.9 mm	Mechanical seal and o-ring	4 oz./114 g
3430-0593	9303P	5/8"	15.9 mm	Mechanical seal, o-ring, gasket and washer for under acorn nut	4 oz./114 g
3430-0601	9305C and 9305C-SP	5/8"	15.9 mm	Mechanical seal and o-ring	4 oz./114 g
3430-0590	All Poly Models	3/4"	19 mm	Mechanical seal, o-ring, gasket and washer for under acorn nut	4 oz./114 g
3430-0604	9307 Series	1-3/8"	35 mm	Mechanical seal, o-ring and gasket	4 oz./114 g
3430-0646	9205 Models	3/4"	19 mm	Mechanical seal and o-ring	4 oz./114 g
3430-0591	9000C-O and 9000C-O-SP	3/4"	19 mm	Mechanical seal and o-ring	4 oz./114 g

# Self-Priming Adaptor (SPA)

Provides Fast Self-Priming for Closed Impeller Centrifugal Pumps



- Creates self-priming capability for all standard centrifugal pump models
- Increases priming efficiency over open impeller transfer pumps and self-priming centrifugal pumps
- Allows the use of a single, high efficiency pump for both tank filling and spraying
- Constructed out of 304 stainless steel for corrosion resistance
- Protects the pump's mechanical seal from dry-run during priming operations for on-board loading
- Guards against unexpected dry-run conditions during spraying application, if system were to function automatically
- Allows centrifugal pumps to be mounted in tight-fitting configurations while maintaining priming and flow performance capabilities
- SPA can be mounted in nearby remote location up to 10 ft (3 m) from pump

## Order Information

Model Number	Description
1530-0024S	2" NPT Self-Priming Adaptor
1530-0028S	2" NPT High Volume Self-Priming Adaptor
3430-0700	Mounting Kit

## Self-Priming Adaptor Configuration

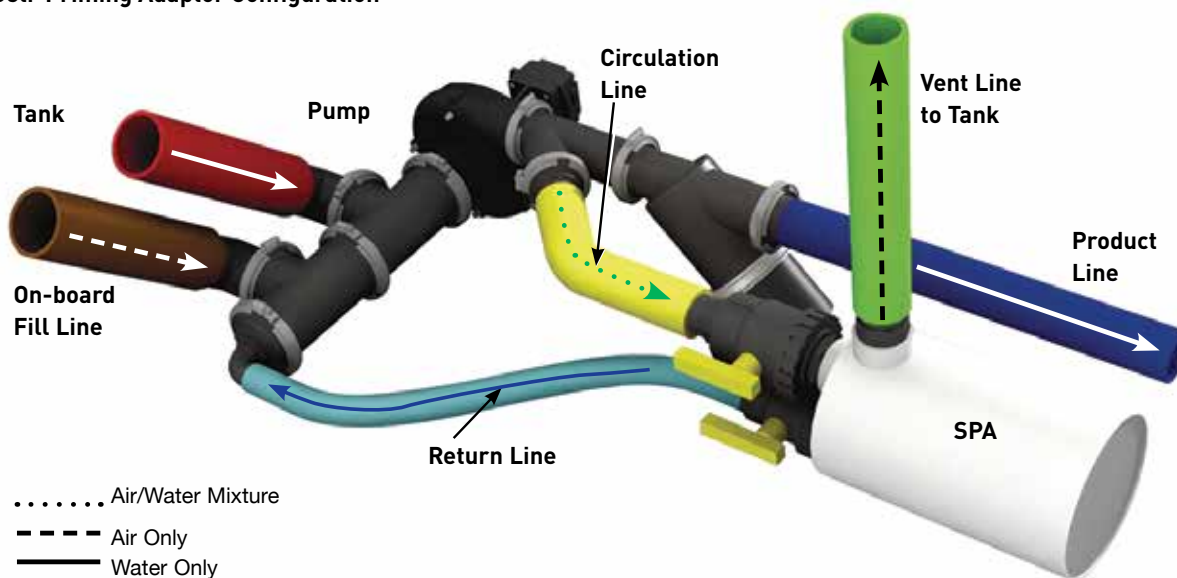

## How the Self-Priming Adaptor Works

To facilitate pump priming, liquid is circulated through the pump and eye of the impeller. The attached Self-Priming Adaptor (SPA) stores an initial amount of liquid for the priming operation. The SPA, when activated with two ball valves, separates the air from the liquid being circulated and releases it back to the atmosphere through the vent line. Only liquid returns back to the pump inlet, thereby eliminating the inlet suction line of air. Once the pump is primed, pump pressure and flow increases. Flow is directed to the tank. The operator then closes the two ball valves, shutting off the circulation path between the pump and SPA.

# Centrifugal Pump Accessories

## 12 Volt Clutch



Part Number	Shaft Size	Pulley Type	Max. HP	Max. RPM	Max. AMPS @ 12V	Pump Model	Est. Weight Ea.
2526-0011	7/8" (19 mm)	5.25" (140 mm)-A	30	5000	4.85	9203P, 9253P-C, 9500P-S, 9205C, 9205C-SP	8 lbs./3.6kg
3430-0592	5/8" (15.9 mm)	5.00" (125 mm) Double Groove-A	30	5000	3.75	9202C, 9203C, 9206C, 9203C-R, 9262C-C, 9263C-C, 9263C-CR, 9203C-SP, 92625-C, 9263S-C, 9263S-CR, 9263C-C-SP, 9263C-CR-SP	9 lbs./4.1kg

## Vent Line Kit



Part Number	Description	Est. Weight Ea.
3430-0456	Vent line kit with 25' (6.3 m) long, 1/4" ID vinyl hose, 1/8" NPT x 1/4" HB 90° nylon elbow fitting, 1/8" NPT x 1/4" HB straight polypropylene fitting, plastic hose clamp and plastic cable tie. Works with all Hypro centrifugals.	14 oz./397g
3430-0797	Push-to-connect vent line kit with 25' (6.3 m) long, 1/4" polyethylene tubing, 1/8" MNPT x 1/4" push-to-connect straight, 1/8" MNPT x 1/4" push-to-connect 90° elbow, and plastic cable ties. Works with all Hypro centrifugal pumps.	14 oz./397g

## PTO Mounting Clips



Part Number	Pump Series	Est. Weight Ea.
1520-0034	9000C-0 (not for 9040 Series)	4 lbs./1.8 kg

## Hydraulic Test Kit



Part Number	Description	Est. Weight Ea.
3430-0650	Hydraulic test kit with pressure and tank fixtures with flow meter and digital pressure gauges. Works with all Hypro HM series motors.	20 lbs./9.1 kg

## Centrifugal Pump Repair Tools

Part Number	Pump Series	Description
3010-0061	9000	Main bearing support tool
3010-0064	9000, 9200, 9300	Support bar/sleeve extractor
3010-0066	9200, 9300	Wire brush
3010-0067	9200, 9300	Wire brush holder
3010-0084	9000, 9200, 9300	Internal/external retaining ring pliers
3010-0167	9000, 9300	Internal/external retaining ring pliers
3010-0168	9000, 9200, 9300	Tool box
3020-0008	9300	Allen wrench; 1/4" hex
3020-0009	9200, 9300	Allen wrench; 1/16" hex
3430-0650	9300	Hydraulic test kit



# Transfer Pump Selection

## Material Options:

### Aluminum



**Typical Use:** Water Transfer

The aluminum construction does not lend itself well to chemical transfer.

**Options include:**  
2" and 3" semi-trash and 3" trash

### Cast Iron



**Typical Use:** Liquid Fertilizer Transfer

Cast iron transfer pumps have thicker castings and stand up well to high density liquid fertilizers.

**Options include:**  
2" and 3" models available

### Polypropylene



**Typical Use:** Chemical Transfer

Polypropylene has excellent corrosion resistance to virtually all Agricultural chemicals.

**Options include:**  
2" and 3" models available

## Drive Options:

### Gas Engine



**Typical Use:**  
Outdoor applications in a mobile environment such as on a sprayer nurse/tender trailer.

### Hydraulic Motor



**Typical Use:**  
Applications where a smaller footprint is desired and hydraulic power is available.

### Electric Motor



**Typical Use:**  
Indoor and outdoor stationary applications where electrical power is available.

# Polypropylene, Gas Engine-Driven, 2 in. & 3 in.

## 1542P and 1543P



1542P-65SP



1543P-130SP

- Multiple gas engine options, including field proven Hypro PowerPro, Honda® and Briggs & Stratton® engines (EPA & CARB certified – North America; EC/CE Listed - Europe)
- Housings: 2" x 2" Polypropylene or 3" x 3" polypropylene – highest performance available in a 3" transfer pump with highest efficiency and horsepower on the market
- Pump Seals: EPDM Mechanical
- Suction Lift: 25 ft./7.62 m
- Poly impeller with stainless steel insert (3"); Nylon impeller (2")
- 2" versions available with or without frame

### Order Information 2" Gas Engine-Driven

Model Number	Max GPM	Max LPM	Max PSI	Max BAR	Port Size	Impeller Profile	Engine Mfrg. & HP
1542P-65SP	200	757	58	4.0	2" x 2" NPT	5 vane	PowerPro 6.5 hp
1542P-65SPM	200	757	58	4.0	2" x 2" NPT	5 vane	PowerPro 6.5 hp with frame
1542P-65ESP	200	757	58	4.0	2" x 2" NPT	5 vane	PowerPro 6.5 hp w/ elec. start
1442P-65SP	200	757	58	4.0	2" x 2" NPT	5 vane	6.5 HP EC/CE listed
1542P-160HSP	200	757	58	4.0	2" x 2" NPT	5 vane	Honda® GX160
1542P-200HSP	200	757	58	4.0	2" x 2" NPT	5 vane	Honda® GX200
1542P-950BSP	200	757	58	4.0	2" x 2" NPT	5 vane	Briggs & Stratton® 950
1542P-55SP	150	568	58	4.0	2" x 2" NPT	3 vane	PowerPro 6.5 hp
1542P-550BSP	150	568	58	4.0	2" x 2" NPT	3 vane	Briggs & Stratton® 550
3410-0041	Cam lock kit						
3430-0690	Pump head kit for 1542P-55SP with EPDM seal						
3430-0691	Pump head kit for 1542P-65SP with EPDM seal						
3430-0635	EPDM seal kit						
3430-0659	Viton seal kit						

### 1542P-55SP, 1542P-550BSP

#### U.S. Units

GPM at 0 PSI	GPM at 10 PSI	GPM at 20 PSI	GPM at 30 PSI	GPM at 40 PSI	GPM at 50 PSI	GPM at 58 PSI
150	147	131	108	80	48	0

### 1542P-55SP, 1542P-550BSP

#### Metric Units

LPM at 0 BAR	LPM at 0.7 BAR	LPM at 1.4 BAR	LPM at 2.1 BAR	LPM at 2.8 BAR	LPM at 3.4 BAR	LPM at 4.0 BAR
568	556	496	409	303	182	0

### 1542P-65SP, 1542P-200HSP, 1542P-950BSP

#### U.S. Units

GPM at 0 PSI	GPM at 10 PSI	GPM at 20 PSI	GPM at 30 PSI	GPM at 40 PSI	GPM at 50 PSI	GPM at 58 PSI
200	182	162	136	106	65	0

### 1542P-65SP, 1542P-200HSP, 1542P-950BSP

#### Metric Units

LPM at 0 BAR	LPM at 0.7 BAR	LPM at 1.4 BAR	LPM at 2.1 BAR	LPM at 2.8 BAR	LPM at 3.4 BAR	LPM at 4.0 BAR
757	689	613	515	401	246	0

### Order Information 3" Gas Engine-Driven

Model Number	Max GPM	Max LPM	Max PSI	Max BAR	Port Size	Impeller Profile	Engine Mfrg. & HP
1543P-130SP	440	1666	54	3.7	3" x 3" NPT	5 vane	PowerPro 13 HP
1543P-130ESP	440	1666	54	3.7	3" x 3" NPT	5 vane	PowerPro 13 HP w/ elec. start
1543P-130ESP-01	440	1666	54	3.7	300 x 300 UF	5 vane	PowerPro 13 HP w/ elec. start
1543-390EHSP	440	1666	54	3.7	3" x 3" NPT	5 vane	Honda® GX390 w/ elec. start
3410-0042	Cam lock kit						
3430-0692	Pump head kit with EPDM seal						
3430-0692-02	Pump head kit with EPDM seal and 3" UF Fittings						
3430-0757	EPDM seal kit						
3430-0838	Viton seal kit						

### 1543P-130SP, 1543P-130ESP, 1543P-390EHSP, 1543P-130ESP-01 U.S. Units

GPM at 0 PSI	GPM at 10 PSI	GPM at 20 PSI	GPM at 30 PSI	GPM at 40 PSI	GPM at 50 PSI	GPM at 58 PSI
440	400	338	269	184	68	0

### 1543P-130SP, 1543P-130ESP, 1543P-390EHSP, 1543P-130ESP-01 Metric Units

LPM at 0 BAR	LPM at 0.7 BAR	LPM at 1.4 BAR	LPM at 2.1 BAR	LPM at 2.8 BAR	LPM at 3.4 BAR	LPM at 4.0 BAR
1666	1514	1279	1018	697	257	0

Viton® is a registered trademark of DuPont.  
Hypro® is a registered trademark of Pentair.

Honda® is a registered trademark of Honda Motor Co., Ltd.  
Briggs & Stratton® is a registered trademark of Briggs & Stratton Corporation.

# Polypropylene, Hydraulically-Driven, 2 in & 3 in.

## Series 9342P and 9343P



- Housing: 2" x 2" or 3" X 3" Polypropylene
- Pump Seals: EPDM Mechanical
- Suction lift: 25 ft./7.62 m
- Poly impeller with stainless steel insert

### Order Information 2" Hydraulically-Driven

Model Number	Max GPM	Max LPM	Max PSI	Max BAR	Port Size	Motor Capacity
9342P-HM1C-5SP	200	757	58	t40	2" x 2" NPT	10 gpm
9342P-HM5C-5SP	206	780	60	41	2" x 2" NPT	11 gpm
3430-0690	Pump head kit for HM1C with EPDM seal					
3430-0691	Pump head kit for HM5C with EPDM seal					
3430-0635	EPDM seal kit					
3430-0659	Viton seal kit					
3410-0041	Cam lock kit					

### Order Information 3" Hydraulically-Driven

Model Number	Max GPM	Max LPM	Max PSI	Max BAR	Port Size	Engine Mfg. & HP
9343P-GM6-SP	450	1703	52	3.6	3" x 3" NPT	Hydraulic
9343P-GM6Y-SP*	450	1703	52	3.6	3" x 3" NPT	Hydraulic
9343P-GM10-SP	484	1832	58	4.0	3" x 3" NPT	Hydraulic
9343P-GM10Y-SP*	484	1832	58	4.0	3" x 3" NPT	Hydraulic
3430-0692	Pump head kit with EPDM seal					
3430-0692-02	Pump head kit with EPDM seal and 3" UF fittings					
3430-0757	EPDM seal kit					
3430-0838	Viton seal kit					
3410-0042	Cam lock kit					

\* Y= case drain motor

### 9342P-HM1C-5SP

#### U.S. Units

Hyd. Flow GPM	GPM at 0 PSI	GPM at 10 PSI	GPM at 20 PSI	GPM at 30 PSI	GPM at 40 PSI	GPM at 50 PSI	GPM at 58 PSI
8	165	145	122	95	57		
9	185	166	144	119	86	0	
10	200	184	164	141	114	80	0

### 9342P-HM1C-5SP

#### Metric Units

Hyd. Flow LPM	LPM at 0 BAR	LPM at 0.7 BAR	LPM at 1.4 BAR	LPM at 2.1 BAR	LPM at 2.8 BAR	LPM at 3.4 BAR	LPM at 4.0 BAR
30.3	625	549	463	358	215		
34.1	700	630	547	449	325	0	
37.9	757	695	620	534	433	301	0

### 9342P-HM5C-5SP

#### U.S. Units

Hyd. Flow GPM	GPM at 0 PSI	GPM at 10 PSI	GPM at 20 PSI	GPM at 30 PSI	GPM at 40 PSI	GPM at 50 PSI	GPM at 60 PSI
9	175	154	123	84	0		
10	192	174	149	118	76	0	
11	206	189	169	145	117	79	0

### 9342P-HM5C-5SP

#### Metric Units

Hyd. Flow LPM	LPM at 0 BAR	LPM at 0.7 BAR	LPM at 1.4 BAR	LPM at 2.1 BAR	LPM at 2.8 BAR	LPM at 3.4 BAR	LPM at 4.1 BAR
34.1	662	582	467	316	0		
37.9	727	658	562	446	288	0	
41.6	780	717	639	550	442	299	0

### 9343P-GM6-SP

#### US Units

Performance	Feet PSI	0	12	23	35	46	58	69	81	92	104	116	127
8 gal/min	GPM	342	316	284	240	176	67	-	-	-	-	-	-
9 gal/min	GPM	378	355	327	294	252	194	103	-	-	-	-	-
10 gal/min	GPM	414	394	371	345	314	276	227	155	52	-	-	-
11 gal/min	GPM	450	433	414	392	368	340	307	265	210	128	28	-

### 9343P-GM6-SP

#### Metric Units

Performance	m BAR	5.1	10.2	12.8	15.3	17.9	20.4	23.0	25.5	28.1	30.6	33.2	35.7
30 l/min	LPM	1110	885	730	495	145	165	-	-	-	-	-	-
35 l/min	LPM	1335	1180	1085	970	825	630	345	35	-	-	-	-
40 l/min	LPM	1545	1425	1355	1270	1185	1080	960	805	600	325	45	-

### 9343P-GM10-SP

#### US Units

Performance	Feet PSI	0	12	23	35	46	58	69	81	92	104	116	127
12 gal/min	GPM	364	340	310	274	227	157	46	-	-	-	-	-
13 gal/min	GPM	391	368	342	312	275	227	158	55	-	-	-	-
14 gal/min	GPM	415	395	373	348	318	282	236	170	74	-	-	-
15 gal/min	GPM	445	426	406	383	357	327	292	247	187	102	7	-
16 gal/min	GPM	484	466	446	425	401	374	344	309	266	211	139	47

### 9343P-GM10-SP

#### Metric Units

Performance	m BAR	5.1	10.2	12.8	15.3	17.9	20.4	23.0	25.5	28.1	30.6	33.2	35.7
45 l/min	LPM	1225	1045	925	775	560	250	43	-	-	-	-	-
50 l/min	LPM	1390	1240	1150	1045	920	760	540	255	-24	-	-	-
55 l/min	LPM	1535	1405	1335	1255	1165	1060	935	780	575	310	35	-
60 l/min	LPM	1730	1610	1540	1470	1390	1305	1215	1105	985	840	665	445

# Polypropylene, Pedestal Mount, 3 in.

## Series 9243P



- Housing: 3" X 3" Polypropylene
- Pump Seals: EPDM Mechanical
- Suction lift: 25 ft./7.62 m
- Poly impeller with stainless steel insert

### Order Information

Model Number	Max GPM	Max LPM	Max PSI	Max BAR	Port Size
9243P-SP	460	1741	54	3.7	3" x 3" NPT
3430-0692	Pump head kit with EPDM seal				
3430-0692-02	Pump head kit with EPDM seal and 3" UF Fittings				
3430-0757	EDPM seal kit				
3430-0838	Viton seal kit				
3410-0042	Cam lock kit				

### 9243P-SP

	Feet	U.S. Units										
		0	12	23	35	46	58	69	81	92	104	116
2900	GPM	380	358	342	312	275	224	160	50	-	-	-
	RPM	HP	7.1	6.8	6.5	6.3	6.0	5.6	5.0	4.2	-	-
3200	GPM	424	405	384	359	331	297	251	193	103	0	
	RPM	HP	9.1	8.9	8.7	8.5	8.3	8.0	7.5	7.0	6.2	5.3
3500	GPM	460	445	425	404	379	353	321	280	227	159	70
	RPM	HP	12.2	11.8	11.4	11.1	10.9	10.6	10.2	9.8	9.2	8.5

### 9243P-SP

	m	Metric Units											
		5.1	10.2	12.8	15.3	17.9	20.4	23.0	25.5	28.1	30.6	33.2	35.7
2900	LPM	1325	1193	1097	980	830	637	376	46	-	-	-	
	RPM	kW	5.0	4.7	4.6	4.4	4.1	3.8	3.4	2.9	-	-	
3200	LPM	1497	1378	1301	1215	1118	996	853	660	403	154	-	
	RPM	kW	6.6	6.4	6.3	6.1	6.0	5.7	5.5	5.2	4.7	4.3	
3500	LPM	1650	1537	1471	1403	1328	1242	1139	1016	866	685	467	208
	RPM	kW	8.7	8.3	8.2	8.0	7.9	7.7	7.5	7.2	6.9	6.5	6.0

# Polypropylene, Electric-Driven, 2 in.

## Series 9742P



- Available with either 5 hp or 7.5 hp 50/60 hz TEFC Baldor electric motor
  - Three phase 230/460 volt motors in both 5 hp & 7.5 hp
  - Single phase 230 volt motor available in 5 hp
- Housing: 2" x 2" Polypropylene
- Pump Seals: EPDM Mechanical
- Suction Lift: 25ft/7.62m
- Nylon impeller

### Order Information 50 Hz

Model Number	Max GPM	Max LPM	Max PSI	Max BAR	Port Size	Engine Mfg. & HP	Mounting Bolts
9742P-050SPT	120	454	32	2.2	2" x 2" NPT	Polypropylene	5/16" or M8
9742P-050SPT3	120	454	32	2.2	2" x 2" NPT	Polypropylene	5/16" or M8
9742P-075SPT3	160	606	37	2.6	2" x 2" NPT	Polypropylene	5/16" or M8

### Order Information 60 Hz

Model Number	Max GPM	Max LPM	Max PSI	Max BAR	Port Size	Engine Mfg. & HP	Mounting Bolts
9742P-050SPT	150	568	47	3.2	2" x 2" NPT	Polypropylene	5/16" or M8
9742P-050SPT3	150	568	47	3.2	2" x 2" NPT	Polypropylene	5/16" or M8
9742P-075SPT3	188	712	54	3.7	2" x 2" NPT	Polypropylene	5/16" or M8

### 9742P-050SPT & 9742P-050SPT3

60 Hz	PSI	0	5	10	15	20	25	30	35	40	45	47
	GPM	150	142	133	123	111	97	84	66	43	9	0
50 Hz	PSI	0	5	10	15	20	25	30	32	-	-	-
	GPM	120	110	100	85	67	42	10	0	-	-	-

### US

### 9742P-050SPT & 9742P-050SPT3

60 Hz	BAR	0	0.3	0.7	1	1.4	1.7	2.1	2.4	2.8	3.1	3.2
	LPM	568	538	503	466	420	367	318	250	163	34	0
50 Hz	BAR	0	0.3	0.7	1	1.4	1.7	2.1	2.2	-	-	-
	LPM	454	416	379	322	254	159	38	0	-	-	-

### Metric

### 9742P-075SPT3

60 Hz	PSI	0	5	10	15	20	25	30	35	40	45	50	54
	GPM	188	185	181	173	163	151	136	120	102	76	44	0
50 Hz	PSI	0	5	10	15	20	25	30	35	37	-	-	-
	GPM	160	155	143	129	112	90	65	20	0	-	-	-

### US

### 9742P-075SPT3

60 Hz	BAR	0	0.3	0.7	1	1.4	1.7	2.1	2.4	2.8	3.1	3.4	3.7
	LPM	712	700	685	655	617	572	515	454	386	288	167	0
50 Hz	BAR	0	0.3	0.7	1	1.4	1.7	2.1	2.4	2.6	-	-	-
	LPM	606	587	541	488	424	341	246	76	0	-	-	-

### Metric

# Cast Iron Gas, Engine-Driven, 2 in. & 3 in.

## Series 1530



1532C-6SP with PowerPro Engine

- Gas engine driven (EPA & CARB certified)
- Suction lift: 20 ft. (6 m)
- Pump seals: fluoroelastomer (viton)
- Flapper valve: EPDM

### Order Information

Model Number	Max GPM	Max LPM	Max PSI	Max BAR	Port Size	Engine Mfg. & HP
1532C-6SP	170	644	42	2.9	2" x 2" NPT	PowerPro 6.5 hp
1532C-160HSP	170	644	42	2.9	2" x 2" NPT	Honda GX160
1533C-13SP	330	1249	60	4.1	3" x 3" NPT	PowerPro 13 hp
1533C-13ESP	330	1249	60	4.1	3" x 3" NPT	PowerPro 13 hp w/ electric start
1533C-390EHSP	330	1249	60	4.1	3" x 3" NPT	Honda GX390 w/ electric start
3430-0673CSP	170	644	42	2.9	Pump head kit for 2" NPT self-priming cast iron transfer pump	
3430-0674CSP	330	1249	60	4.1	Pump head kit for 3" NPT self-priming cast iron transfer pump	

### 1532C-6SP, 1532C-160HSP

U.S. Units									
GPM at 0 PSI	GPM at 5 PSI	GPM at 10 PSI	GPM at 15 PSI	GPM at 20 PSI	GPM at 25 PSI	GPM at 30 PSI	GPM at 35 PSI	GPM at 40 PSI	GPM at 42 PSI
170	155	140	123	106	87	65	42	14	0

### 1532C-6SP, 1532-160HSP

Metric Units									
LPM at 0.0 BAR	LPM at 0.3 BAR	LPM at 0.7 BAR	LPM at 1.0 BAR	LPM at 1.4 BAR	LPM at 1.7 BAR	LPM at 2.1 BAR	LPM at 2.4 BAR	LPM at 2.8 BAR	LPM at 2.9 BAR
644	587	530	466	401	329	246	159	53	0

### 1533C-13SP, 1533C-13ESP, 1533C-390EHSP

U.S. Units													
GPM at 0 PSI	GPM at 5 PSI	GPM at 10 PSI	GPM at 15 PSI	GPM at 20 PSI	GPM at 25 PSI	GPM at 30 PSI	GPM at 35 PSI	GPM at 40 PSI	GPM at 45 PSI	GPM at 50 PSI	GPM at 60 PSI	GPM at 66 PSI	GPM at 66 PSI
330	325	321	315	296	273	248	221	192	161	129	48	0	0

### 1533C-13SP, 1533C-13ESP, 1533C-390EHSP

Metric Units													
LPM at 0.0 BAR	LPM at 0.3 BAR	LPM at 0.7 BAR	LPM at 1.0 BAR	LPM at 1.4 BAR	LPM at 1.7 BAR	LPM at 2.1 BAR	LPM at 2.4 BAR	LPM at 2.8 BAR	LPM at 3.1 BAR	LPM at 3.4 BAR	LPM at 4.1 BAR	LPM at 4.6 BAR	LPM at 4.6 BAR
1249	1230	1215	1192	1120	1033	938	836	726	609	488	181	0	0

# Cast Iron, Pedestal-Mount, 2 in. & 3 in.



3430-0674CSP



9232C-SP

### Order Information

Model Number	Max GPM	Max LPM	Max PSI	Max BAR	Description
9232C-SP	170	644	42	2.9	2" x 2" NPT self priming pedestal-mount cast iron transfer pump
9233C-SP	330	1249	60	4.1	3" x 3" NPT self priming pedestal-mount cast iron transfer pump
3430-0673CSP	170	644	42	2.9	Pump head kit for 2" NPT self-priming cast iron transfer pump
3430-0674CSP	330	1249	60	4.1	Pump head kit for 3" NPT self-priming cast iron transfer pump
3430-0675	Replacement pedestal for 2" NPT self-priming cast iron transfer pump				
3430-0676	Replacement pedestal for 3" NPT self-priming cast iron transfer pump				

### 9232C-SP, 3430-0673CSP

U.S. Units										
GPM at 0 PSI	GPM at 5 PSI	GPM at 10 PSI	GPM at 15 PSI	GPM at 20 PSI	GPM at 25 PSI	GPM at 30 PSI	GPM at 35 PSI	GPM at 40 PSI	GPM at 42 PSI	GPM at 42 PSI
170	155	140	123	106	87	65	42	14	0	0

### 9232C-SP, 3430-0673CSP

Metric Units										
LPM at 0.0 BAR	LPM at 0.3 BAR	LPM at 0.7 BAR	LPM at 1.0 BAR	LPM at 1.4 BAR	LPM at 1.7 BAR	LPM at 2.1 BAR	LPM at 2.4 BAR	LPM at 2.8 BAR	LPM at 2.9 BAR	LPM at 2.9 BAR
644	587	530	466	401	329	246	159	53	0	0

### 9233C-SP, 3430-0674CSP

U.S. Units													
GPM at 0 PSI	GPM at 5 PSI	GPM at 10 PSI	GPM at 15 PSI	GPM at 20 PSI	GPM at 25 PSI	GPM at 30 PSI	GPM at 35 PSI	GPM at 40 PSI	GPM at 45 PSI	GPM at 50 PSI	GPM at 60 PSI	GPM at 66 PSI	GPM at 66 PSI
330	325	321	315	296	273	248	221	192	161	129	48	0	0

### 9233C-SP, 3430-0674CSP

Metric Units													
LPM at 0.0 BAR	LPM at 0.3 BAR	LPM at 0.7 BAR	LPM at 1.0 BAR	LPM at 1.4 BAR	LPM at 1.7 BAR	LPM at 2.1 BAR	LPM at 2.4 BAR	LPM at 2.8 BAR	LPM at 3.1 BAR	LPM at 3.4 BAR	LPM at 4.1 BAR	LPM at 4.6 BAR	LPM at 4.6 BAR
1249	1230	1215	1192	1120	1033	938	836	726	609	488	181	0	0

# Cast Iron, Hydraulically-Driven, 2 in.



9332C-HM\_C-SP

- Housing: cast iron
- Pump seals: fluoroelastomer (viton)
- Suction lift: 20 ft. (6 m)
- Flapper valve: EPDM

## Order Information

Model Number	Max GPM	Max LPM	Max PSI	Max BAR	Hyd. Flow GPM	Hyd. Flow LPM	Port Size
9332C-HM1C-SP	170	644	60	4.1	13	49	2" x 2" NPT
9332C-HM5C-SP	170	644	60	4.1	16	60	2" x 2" NPT

## 9332C-HM1C-SP

### U.S. Units

Hyd. Flow GPM	GPM at 0 PSI	GPM at 5 PSI	GPM at 10 PSI	GPM at 20 PSI	GPM at 30 PSI	GPM at 40 PSI	GPM at 50 PSI	GPM at 60 PSI
8	150	138	124	88	53	0		
9	160	150	140	113	79	48	0	
10	170	163	155	135	108	77	42	0

## 9332C-HM1C-SP

### Metric Units

Hyd. Flow LPM	LPM at 0.0 BAR	LPM at 0.3 BAR	LPM at 0.7 BAR	LPM at 1.4 BAR	LPM at 2.1 BAR	LPM at 2.8 BAR	LPM at 3.4 BAR	LPM at 4.1 BAR
30	568	522	469	333	201	0		
34	606	567	530	428	229	182	0	
38	643	617	587	511	409	291	159	0

## 9332C-HM5C-SP

### U.S. Units

Hyd. Flow GPM	GPM at 0 PSI	GPM at 5 PSI	GPM at 10 PSI	GPM at 20 PSI	GPM at 30 PSI	GPM at 40 PSI	GPM at 50 PSI	GPM at 60 PSI
10	150	138	123	90	55	0		
11	160	150	140	113	79	48	0	
12	170	163	155	135	108	77	42	0

## 9332C-HM5C-SP

### Metric Units

Hyd. Flow LPM	LPM at 0.0 BAR	LPM at 0.3 BAR	LPM at 0.7 BAR	LPM at 1.4 BAR	LPM at 2.1 BAR	LPM at 2.8 BAR	LPM at 3.4 BAR	LPM at 4.1 BAR
38	568	522	466	341	208	0		
42	606	568	530	428	299	182	0	
45	644	617	587	511	409	291	158	0

# Cast Iron, Electric Motor Mount, 2 in. & 3 in.



- Housing: cast iron
- Pump seals: fluoroelastomer (viton)
- Suction lift: 20 ft. (6 m)
- Flapper valve: EPDM

## Order Information

Model Number	Max GPM	Max LPM	Max PSI	Max BAR	Port Size	NEMA Frame
9732C-SPX*	170	644	42	2.9	2" x 2" NPT	182/184TC
9733C-SPX*	330	1249	60	4.1	3" x 3" NPT	215TC

\* Electric Motor not included

## 9732C-SPX

### U.S. Units

GPM at 0 PSI	GPM at 5 PSI	GPM at 10 PSI	GPM at 15 PSI	GPM at 20 PSI	GPM at 25 PSI	GPM at 30 PSI	GPM at 35 PSI	GPM at 40 PSI
170	151	133	113	94	74	52	25	0

## 9732C-SPX

### Metric Units

LPM at 0.0 BAR	LPM at 0.3 BAR	LPM at 0.7 BAR	LPM at 1.0 BAR	LPM at 1.4 BAR	LPM at 1.7 BAR	LPM at 2.1 BAR	LPM at 2.4 BAR	LPM at 2.8 BAR
644	572	503	428	356	280	197	95	0

## 9733C-SPX

### U.S. Units

GPM at 0 PSI	GPM at 5 PSI	GPM at 10 PSI	GPM at 15 PSI	GPM at 20 PSI	GPM at 25 PSI	GPM at 30 PSI	GPM at 35 PSI	GPM at 40 PSI	GPM at 45 PSI	GPM at 50 PSI	GPM at 55 PSI	GPM at 60 PSI	GPM at 61 PSI
330	325	320	310	290	265	230	195	163	133	95	50	11	0

## 9733C-SPX

### Metric Units

LPM at 0.0 BAR	LPM at 0.3 BAR	LPM at 0.7 BAR	LPM at 1.0 BAR	LPM at 1.4 BAR	LPM at 1.7 BAR	LPM at 2.1 BAR	LPM at 2.4 BAR	LPM at 2.8 BAR	LPM at 3.1 BAR	LPM at 3.4 BAR	LPM at 3.8 BAR	LPM at 4.1 BAR	LPM at 4.2 BAR
1249	1230	1211	1173	1098	1003	871	738	617	503	360	190	42	0

# Aluminum Gas Engine-Driven, 2 in. & 3 in.

## Series 1540A



1541A-SP



1543A-65TSP



1543A-65SP

- PowerPro Gas engine driven (EPA & CARB certified)
- Housing: Aluminum
- Pump seals: EPDM Mechanical
- Suction lift:
  - 13 ft./4m (1541A)
  - 23 ft./7.01m (1542A & 1543A)
- Trash pumps will handle 1-1/8" (29 mm) solids
- Transfer pumps will handle 3/8" (9.5mm) solids
- Framed: 1542A & 1543A versions only

### Order Information

Model Number	Max GPM	Max LPM	Max PSI	Max BAR	Port Size	Engine Mfr. & HP
1541A-SP	40	151	28	1.9	2" x 2" BSP	PowerPro 2.5 hp
1542A-65SP	147	556	50	3.4	2" x 2" NPT	PowerPro 6.5 hp
1542A-160HSP	147	556	50	3.4	2" x 2" NPT	Honda® GX160
1542A-550BSP	147	556	50	3.4	2" x 2" NPT	Briggs & Stratton® 550
1543A-65SP	259	980	50	3.4	3" x 3" NPT	PowerPro 6.5 hp
1543A-160HSP	259	980	50	3.4	3" x 3" NPT	Honda® GX160
1543A-65TSP (Trash)	272	1030	50	3.4	3" x 3" NPT	PowerPro 6.5 hp
1543A-160HTSP	272	1030	50	3.4	3" x 3" NPT	Honda® GX160
3430-0791	3" Trash Kit (NPT ports, SAE 3/4" keyed shaft mount)					
3430-0792	2" Transfer Kit (NPT ports, SAE 3/4" keyed shaft mount)					
3430-0793	3" Transfer Kit (NPT ports, SAE 3/4" keyed shaft mount)					

### 1541A-SP

#### U.S. Units

GPM at 0 PSI	GPM at 10 PSI	GPM at 15 PSI	GPM at 20 PSI	GPM at 25 PSI	GPM at 28 PSI
40	28	21	14	7	0

### 1541A-SP

#### Metric Units

LPM at 0 BAR	LPM at 0.7 BAR	LPM at 1.0 BAR	LPM at 1.4 BAR	LPM at 1.7 BAR	LPM at 1.9 BAR
151.4	106.0	79.5	53.0	26.5	0

### 1542A-65SP, 1542A-160HSP, 1542P-550BSP

#### U.S. Units

GPM at 5 PSI	GPM at 10 PSI	GPM at 15 PSI	GPM at 20 PSI	GPM at 25 PSI	GPM at 30 PSI	GPM at 35 PSI	GPM at 40 PSI	GPM at 45 PSI	GPM at 50 PSI
147	144	136.6	124.7	110.2	94.1	78.3	57.1	19.2	0

### 1542A-65SP, 1542A-160HSP, 1542P-550BSP

#### Metric Units

LPM at 0.3 BAR	LPM at 0.7 BAR	LPM at 1.0 BAR	LPM at 1.4 BAR	LPM at 1.7 BAR	LPM at 2.1 BAR	LPM at 2.4 BAR	LPM at 2.8 BAR	LPM at 3.1 BAR	LPM at 3.4 BAR
556.5	545.1	517.1	472	417.2	356.2	296.4	216.1	72.7	0

### 1543A-65SP, 1543A-160HSP

#### U.S. Units

GPM at 5 PSI	GPM at 10 PSI	GPM at 15 PSI	GPM at 20 PSI	GPM at 25 PSI	GPM at 30 PSI	GPM at 35 PSI	GPM at 40 PSI	GPM at 45 PSI	GPM at 50 PSI
259	251.6	233.7	213.6	190.9	162.2	135.8	99.3	56.1	8.7

### 1543A-65SP, 1543A-160HSP

#### Metric Units

LPM at 0.3 BAR	LPM at 0.7 BAR	LPM at 1.0 BAR	LPM at 1.4 BAR	LPM at 1.7 BAR	LPM at 2.1 BAR	LPM at 2.4 BAR	LPM at 2.8 BAR	LPM at 3.1 BAR	LPM at 3.4 BAR
980.4	952.4	884.6	808.6	722.6	614	514.1	375.9	212.4	32.9

### 1543A-65TSP, 1543A-160HTSP

#### U.S. Units

GPM at 5 PSI	GPM at 10 PSI	GPM at 15 PSI	GPM at 20 PSI	GPM at 25 PSI	GPM at 30 PSI	GPM at 35 PSI	GPM at 40 PSI	GPM at 45 PSI	GPM at 50 PSI
272	269.8	241	207.6	179.3	140.4	98.1	50.7	5.4	0

### 1543A-65TSP, 1543A-160HTSP

#### Metric Units

LPM at 0.3 BAR	LPM at 0.7 BAR	LPM at 1.0 BAR	LPM at 1.4 BAR	LPM at 1.7 BAR	LPM at 2.1 BAR	LPM at 2.4 BAR	LPM at 2.8 BAR	LPM at 3.1 BAR	LPM at 3.4 BAR
1029.6	1021.3	912.3	785.8	678.7	531.5	371.3	191.9	20.4	0

Honda® is a registered trademark of Honda Motor Co., Ltd.

Briggs & Stratton® is a registered trademark of Briggs & Stratton Corporation. Hypro® is a registered trademark of Pentair Ltd.

# Aluminum, Gas Engine-Driven, 2 in. & 3 in.

## Series 1570

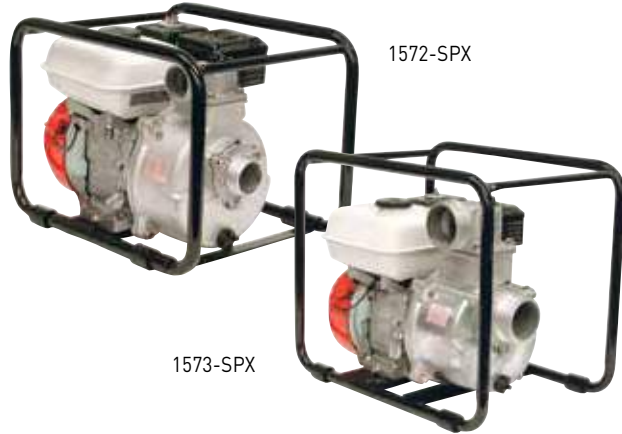

- Honda® engine (EPA & CARB certified)
- Close-coupled, gas engine driven
- Housing: Aluminum
- Pump seals: Buna-N/ceramic
- Inlet valve: Buna-N
- Suction lift: 28 ft./8.53m

### Order Information

Model Number	Max GPM	Max LPM	Max PSI	Max BAR	Port Size	Engine Mfr. & HP
1572-SPX	145	549	50	3.4	2" x 2" NPT	Honda® 4 hp
1573-SPX	280	1060	50	3.4	3" x 3" NPT	Honda® 5.5 hp

### 1572-SPX

### U.S. Units

GPM at 0 PSI	GPM at 5 PSI	GPM at 10 PSI	GPM at 15 PSI	GPM at 20 PSI	GPM at 25 PSI	GPM at 30 PSI	GPM at 35 PSI	GPM at 40 PSI	GPM at 45 PSI	GPM at 50 PSI
145	141	133	125	114	102	87	70	51	24	0

### 1572-SPX

### Metric Units

LPM at 0.0 BAR	LPM at 0.3 BAR	LPM at 0.7 BAR	LPM at 1.0 BAR	LPM at 1.4 BAR	LPM at 1.7 BAR	LPM at 2.1 BAR	LPM at 2.4 BAR	LPM at 2.8 BAR	LPM at 3.1 BAR	LPM at 3.4 BAR
549	534	503	473	432	386	329	265	193	91	

### 1573-SPX

### U.S. Units

GPM at 0 PSI	GPM at 5 PSI	GPM at 10 PSI	GPM at 15 PSI	GPM at 20 PSI	GPM at 25 PSI	GPM at 30 PSI	GPM at 35 PSI	GPM at 40 PSI	GPM at 45 PSI	GPM at 50 PSI
280	268	255	233	211	181	149	115	77	46	0

### 1573-SPX

### Metric Units

LPM at 0.0 BAR	LPM at 0.3 BAR	LPM at 0.7 BAR	LPM at 1.0 BAR	LPM at 1.4 BAR	LPM at 1.7 BAR	LPM at 2.1 BAR	LPM at 2.4 BAR	LPM at 2.8 BAR	LPM at 3.1 BAR	LPM at 3.4 BAR
1060	1014	965	882	799	685	564	435	291	174	

## Transfer Pumps Accessories

### Transfer Pump Cam Lock Kit



Hypro cam lock kits easily add heavy-duty male cam lock connections to the NPT ports of 2" and 3" polypropylene pumps.

- Includes one male cam lock adapter for pump inlet
- Includes one heavy-duty 90° elbow and one male cam lock adapter for the pump outlet
- Prepares transfer pumps for the most common means of quick coupling a hose
- Interchangeable with other cam lock fittings made to MIL-C-27487 specifications

### Order Information

Size	Model Number
2" NPT	3410-0041
3" NPT	3410-0042

Honda® is a registered trademark of Honda Motor Co., Ltd.  
Hypro® is a registered trademark of Pentair.



# Roller Pump Comparisons

**Get up to 10 times longer pump life with Hypro Silver Series XL Roller pumps!**

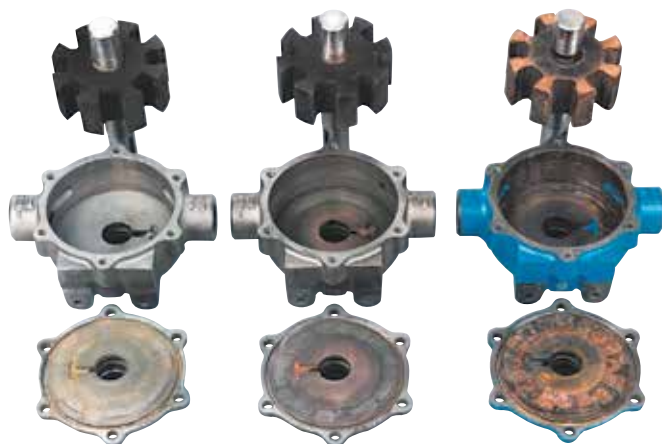

Silver Series XL

Ni-Resist

Cast Iron

These three pump housings were photographed after being tested with a 30:1 mix of water and Roundup® herbicide.

The Ni-Resist and Cast Iron indicate damage from pitting and corrosion, but the Silver Series XL is in like-new condition after more than 1000 hours of use.

### Herbicide Users:

**Get up to 10 times longer pump life!**

- Cast Iron pumps lasted to 140 hours before failure.
- Ni-Resist pumps lasted to 332 hours before failure.
- Silver Series X pumps ran over 1000 hours and still met new pump specs!

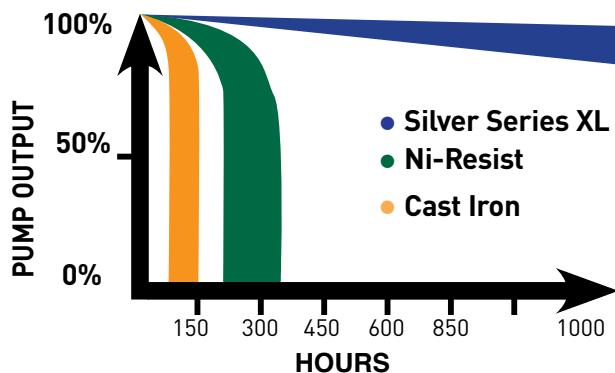

Floating Design, PTFE Coating



Ni-Resist Pumps

### Floating PTFE Coated Rotors

- Floating rotor design and black PTFE coating on metal rotors increases performance and extends pump life
- Standard production in 4001, 4101, 6500, & 7560 Silver Series XL and Ni-Resist pumps

### Clear Coat Finish

- Offers increased protection from chemical attack and from the elements
- Included on all Ni-Resist roller pump

Roundup® is a registered trademark of Monsanto Co.

# Pump Recommendations for Applications

## Which Roller Pump, Rollers and Seals Should You Use?

Material options for rollers and seals are listed in the order of recommendations for usage. These recommendations are only a general guide. For suggestions on specific chemicals or applications, call Pentair's Technical/Applications Department at (800) 445-8360.

Application	Specific Chemicals	Suggestions							
		Housing Materials			Roller Materials			Seal Materials	
		Silver Series XL	Ni-Resist	Cast Iron	Super Roller	Poly Rollers	Teflon® Rollers*	Viton®	Buna-N
WEED CONTROL CHEMICALS	Emulsions, soluble powders, sodium arsenate.	X	X	X	X			X	
	Chemicals containing glyphosate (such as Roundup®) or other acidics	X			X	X	X*	X	
INSECT CONTROL	Emulsions not containing aromatic solvents.	X	X	X	X			X	
BRUSH CONTROL	Heavy-duty sprays using diesel oil for carrier.	X	X	X	X			X	
PEST CONTROL CHEMICALS, FUMIGANTS, ETC.	This category or use includes mosquito sprays, termite control liquids, nematocides, soil and grain fumigants where any of the following chemicals with aromatic solvents are present: Pentachlorophenol, xylene, xylol, benzene, high sulphur fuel or diesel oil. Fumigants containing: ethylene dichloride, ethylene dibromide, carbon tetrachloride, perchlorethylene, trichlorethylene, methyl bromide, and other aromatic solvents.	X	X	X	X			X	
LIQUID FERTILIZERS	Up to 32% nitrogen content, or others if the liquid is atmospheric pressure and the temperature is handled.	X	X			X			X
POWDERED FERTILIZERS	Fertilizers dissolved in water (greenhouse plant food).	X	X	X	X	X		X	X
PUMPING	Large quantities of plain water.	X	X	X	X	X		X	X
SPRAYING	Wettable powder sprays.	X	X	X	X	X		X	X
MATERIAL HANDLING	Heavy abrasive powders in suspension.	X	X	X	X	X		X	X
ACIDS	Mild sulfuric acid for spraying. Mild muriatic acid, inhibited muriatic, etc.	X				X	X*	X	

\*Note: Limit Pressure at 100 psi (6.9 bar) when using Teflon® Rollers.

# Cast Iron, Ni-Resist or Silver Series XL

## Series 4001 4 Roller



- Port size: 3/4" NPT
- Max. fluid temperature: 140°F/60°C
- Housing: Cast Iron (C), Ni-Resist (N) or Silvercast (XL)
- Pump shaft rotation: Clockwise when looking at the shaft end (counter clockwise available)
- Rollers: Super Rollers standard [Poly (T3) and Teflon® (T2)]
- Shaft Seals: Viton® standard
- Available shaft adapters: See page 72
- Special torque arm and base kit is available for gas engines
- Rotor: Cast Iron, Ni-Resist or Silvercast
- Weight: 5 lbs./2.3 kg

Pressure in PSI and BAR	GPM		HP		GPM		HP	
	LPM	HP	LPM	HP	LPM	HP	LPM	HP
	@1100 RPM		@1400 RPM		@1800 RPM			
0 PSI	5.5	.06	7.1	.10	9.1	.14		
0 BAR	20.8	.06	26.9	.10	34.4	.14		
25 PSI	4.9	.14	6.4	.20	8.5	.30		
1.7 BAR	18.5	.14	24.2	.20	32.2	.30		
50 PSI	4.4	.24	5.9	.32	8.0	.46		
3.4 BAR	16.6	.24	22.3	.32	30.3	.46		
75 PSI	4.1	.34	5.6	.44	7.6	.62		
5.2 BAR	15.5	.34	21.2	.44	28.7	.62		
100 PSI	3.8	.41	5.3	.56	7.3	.78		
6.9 BAR	14.4	.41	20.1	.56	27.6	.78		
125 PSI	3.5	.50	5.0	.68	7.0	.95		
8.6 BAR	13.2	.50	18.9	.68	26.5	.95		
150 PSI	3.3	.62	4.8	.78	6.7	1.1		
10.3 BAR	12.5	.62	18.2	.78	25.4	1.1		

### Order Information

Model Number	Max GPM	Max LPM	Max PSI	Max BAR	Max RPM	Shaft Output		
						U.S.	Metric	Shaft
4001C	9.1	34.4	150	10.3	1800	5/8"	15.9 mm	solid
4001C-H	9.1	34.4	150	10.3	1800	1/2"	12.7 mm	hollow
4001	9.1	34.4	150	10.3	1800	5/8"	15.9 mm	solid
4001N-H	9.1	34.4	150	10.3	1800	1/2"	12.7 mm	hollow
4001XL	9.1	34.4	150	10.3	1800	5/8"	15.9 mm	solid
4001XL-H	9.1	34.4	150	10.3	1800	1/2"	12.7 mm	hollow

Teflon® rollers - Add Suffix "T2" - (i.e.: 4001C-T2).  
 Polypropylene rollers - Add Suffix "T3" - (i.e.: 4001C-T3).  
 Reverse rotation\* - Add Suffix "R" - (i.e.: 4001C-R).

# Cast Iron, Ni-Resist or Silver Series XL

## Series 4101 4 Roller



- Port size: 3/4" NPT
- Max. fluid temperature: 140°F/60°C
- Housing: Cast Iron (C), Ni-Resist (N) or Silvercast (XL)
- Pump shaft rotation: Clockwise when looking at the shaft end (counter clockwise available)
- Rollers: Super Rollers standard [Poly (T3) and Teflon® (T2)]
- Shaft Seals: Viton® standard
- Available shaft adapters: See page 72
- Special torque arm and base kit is available for gas engines
- Rotor: Cast Iron, Ni-Resist or Silvercast
- Weight: 5 lbs./2.27 kg

Pressure in PSI and BAR	GPM		HP		GPM		HP	
	LPM	HP	LPM	HP	LPM	HP	LPM	HP
	@1800 RPM		@2200 RPM		@2600 RPM			
0 PSI	5.0	.11	6.2	.14	7.2	.16		
0 BAR	18.9	.11	23.5	.14	27.3	.16		
25 PSI	4.8	.21	5.8	.27	6.9	.30		
1.7 BAR	18.1	.21	21.9	.27	26.1	.30		
50 PSI	4.5	.34	5.6	.40	6.6	.46		
3.4 BAR	17.0	.34	21.2	.40	25.0	.46		
75 PSI	4.2	.45	5.4	.55	6.4	.62		
5.2 BAR	15.9	.45	20.4	.55	24.2	.62		
100 PSI	3.9	.56	5.0	.68	6.0	.76		
6.9 BAR	14.8	.56	18.9	.68	22.7	.76		
125 PSI	3.7	.68	4.7	.82	5.7	.92		
8.6 BAR	14.0	.68	17.8	.82	21.6	.92		
150 PSI	3.4	.78	4.4	.96	5.4	1.08		
10.3 BAR	12.9	.78	16.6	.96	20.4	1.08		

### Order Information

Model Number	Max GPM	Max LPM	Max PSI	Max BAR	Max RPM	Shaft Output		
						U.S.	Metric	Shaft
4101C	7.2	27.3	150	10.3	2600	5/8"	15.9 mm	solid
4101C-H	7.2	27.3	150	10.3	2600	1/2"	12.7 mm	hollow
4101N	7.2	27.3	150	10.3	2600	5/8"	15.9 mm	solid
4101N-H	7.2	27.3	150	10.3	2600	1/2"	12.7 mm	hollow
4101XL	7.2	27.3	150	10.3	2600	5/8"	15.9 mm	solid
4101XL-H	7.2	27.3	150	10.3	2600	1/2"	12.7 mm	hollow

Teflon® rollers - Add Suffix "T2" - (i.e.: 4101C-T2).  
 Polypropylene rollers - Add Suffix "T3" - (i.e.: 4101C-T3).  
 Reverse rotation\* - Add Suffix "R" - (i.e.: 4101C-R).

Teflon® is a registered trademark of E.I. DuPont de Nemours and Co.  
 Viton® is a registered trademark of DuPont. Hypro® is a registered trademark of Pentair.

# Ni-Resist or Silver Series XL

## Series 4001 and 4101 12 volt DC 4 Roller



- Super Rollers and Viton® seals standard
- Locking collar and torque arm come in each package
- Rotor: Ni-Resist (N) or Silvercast (XL)
- Weight: 16-18 lbs./7.3-8.2 kg

Note: All models come in either Ni-Resist or Silver Series XL housings.

### Order Information

Model Number	Max GPM	Max LPM	Max PSI	Max BAR	Max RPM	Shaft Output		
						U.S	Metric	Shaft
4001N-EH	10.4	39.4	30	2.1	1900	1/2"	12.7 mm	hollow
4001N-E2H	9.9	37.5	50	3.4	1600	1/2"	12.7 mm	hollow
4001XL-EH	10.4	39.4	30	2.1	1900	1/2"	12.7 mm	hollow
4001XL-E2H	9.9	37.5	50	3.4	1600	1/2"	12.7 mm	hollow
4101N-EH	7.5	28.4	50	3.4	1900	1/2"	12.7 mm	hollow
4101N-E2H	5.9	22.3	90	6.2	1600	1/2"	12.7 mm	hollow
4101XL-EH	7.5	28.4	50	3.4	1900	1/2"	12.7 mm	hollow
4101XL-E2H	5.9	22.3	90	6.2	1600	1/2"	12.7 mm	hollow

Teflon® rollers - Add Suffix "T2" - (i.e.: 4001N-EHT2).  
 Polypropylene rollers - Add Suffix "T3" - (i.e.: 4001N-EHT3).

### U.S. Units

Series 4101-EH and 4101-E2H	Model 4101N-EH & 4101XL-EH				Model 4101N-E2H & 4101XL-E2H		
	Volts	PSI	AMPS	GPM	PSI	AMPS	GPM
	12.0 (Battery) Engine Off	0	10.0	6.3	0	---	---
5		11.3	6.0	10	8.4	5.3	
10		12.5	5.8	20	11.8	4.8	
15		13.7	5.6	30	13.7	4.65	
20		15.1	5.4	40	16.4	4.4	
25		16.7	5.2	50	19.6	4.05	
30		18.6	5.0	60	22.8	3.65	
35		20.3	4.8	70	25.8	3.20	
40		22.3	4.6	80	28.9	3.00	
45		24.1	4.4	90	31.5	2.75	
13.5 (Alternator) Engine Running	0	10.4	7.5	0	---	---	
	5	11.7	7.0	10	9.1	5.9	
	10	13.0	6.6	20	11.2	5.6	
	15	14.2	6.4	30	13.9	5.25	
	20	15.8	6.2	40	16.9	5.0	
	25	17.4	6.0	50	19.5	4.7	
	30	19.6	5.8	60	22.7	4.35	
	35	20.9	5.6	70	25.7	4.0	
	40	22.5	5.4	80	29.2	3.6	
	45	24.3	5.2	90	31.9	3.4	
50	26.1	5.0	100	34.8	3.2		

### Metric Units

Series 4101-EH and 4101-E2H	Model 4101N-EH & 4101XL-EH			Model 4101N-E2H & 4101XL-E2H			
	Volts	BAR	AMPS	LPM	BAR	AMPS	LPM
	12.0 (Battery) Engine Off	0	10.0	23.8	0	---	---
.3		11.3	22.7	.7	8.4	20.0	
.7		12.5	22.0	1.4	11.8	18.2	
1.0		13.7	21.2	2.1	13.7	17.6	
1.4		15.1	20.4	2.8	16.4	16.7	
1.7		16.7	19.7	3.4	19.6	15.3	
2.1		18.6	18.9	4.1	22.8	13.8	
2.4		20.3	18.2	4.8	25.8	12.1	
2.8		22.3	17.4	5.5	28.9	11.4	
3.1		24.1	16.7	6.2	31.5	10.4	
3.4	25.7	15.9	6.9	34.2	9.84		
13.5 (Alternator) Engine Running	0	10.4	28.4	0	---	---	
	.3	11.7	26.5	.7	9.1	22.3	
	.7	13.0	25.0	1.4	11.2	21.2	
	1.0	14.2	24.2	2.1	13.9	19.9	
	1.4	15.8	23.5	2.8	16.9	18.9	
	1.7	17.4	22.7	3.4	19.5	17.8	
	2.1	19.6	22.0	4.1	22.7	16.5	
	2.4	20.9	21.2	4.8	25.7	15.1	
	2.8	22.5	20.4	5.5	29.2	13.6	
	3.1	24.3	19.7	6.2	31.9	12.9	
3.4	26.1	18.9	6.9	34.8	12.1		

Series 4001-EH and 4001-E2H	Model 4001N-EH & 4001XL-EH				Model 4001N-E2H & 4001XL-E2H		
	Volts	PSI	AMPS	GPM	PSI	AMPS	GPM
	12.0 (Battery) Engine Off	0	12.6	9.0	10	13.9	8.4
5		14.1	8.3	20	18.0	7.9	
10		15.2	8.1	30	22.2	7.2	
15		17.3	7.8	35	25.0	6.9	
20		19.7	7.2	40	27.0	6.5	
25		22.1	6.7	50	31.6	5.9	
13.5 (Alternator) Engine Running	0	13.4	10.4	10	14.4	9.9	
	5	14.8	9.9	20	18.3	9.1	
	10	16.2	9.4	30	22.3	8.5	
	15	18.2	8.9	35	24.5	8.3	
	20	20.5	8.5	40	27.0	8.0	
	25	22.5	8.2	50	31.0	7.3	
30	24.9	7.7	60	36.1	6.8		

Series 4001-EH and 4001-E2H	Model 4001N-EH & 4001XL-EH			Model 4001N-E2H & 4001XL-E2H			
	Volts	BAR	AMPS	LPM	BAR	AMPS	LPM
	12.0 (Battery) Engine Off	0	12.6	34.1	.7	13.9	31.8
.3		14.1	31.4	1.4	18.0	29.9	
.7		15.2	30.7	2.1	22.2	27.3	
1.0		17.3	29.5	2.4	25.0	26.1	
1.4		19.7	27.3	2.8	27.0	24.6	
1.7		22.1	25.4	3.5	31.6	22.3	
13.5 (Alternator) Engine Running	0	13.4	39.4	.7	14.4	37.5	
	.3	14.8	37.5	1.4	18.3	34.4	
	.7	16.2	35.6	2.1	22.3	32.2	
	1.0	18.2	33.7	2.4	24.5	31.4	
	1.4	20.5	32.2	2.8	27.0	30.3	
	1.7	22.5	31.0	3.5	31.0	27.6	
2.1	24.9	29.1	4.1	36.1	25.7		

Teflon® is a registered trademark of E.I. DuPont de Nemours and Co.  
 Viton® is a registered trademark of DuPont. Hypro® is a registered trademark of Pentair.

# Cast Iron, Ni-Resist or Silver Series XL

## Series 6500 6-Roller



Pressure in PSI and BAR	GPM	HP	GPM	HP	GPM	HP
	LPM	HP	LPM	HP	LPM	HP
	@540 RPM		@1000 RPM		@1200 RPM	
0 PSI	9.7	.08	18.2	.20	21.8	.30
0 BAR	36.7	.08	68.9	.20	82.5	.30
50 PSI	8.0	.38	16.5	.71	20.1	.90
3.4 BAR	30.3	.38	62.4	.71	76.1	.90
100 PSI	7.2	.68	15.4	1.26	19.1	1.51
6.9 BAR	27.3	.68	58.3	1.26	72.3	1.51
150 PSI	6.6	.97	14.7	1.80	18.2	2.14
10.3 BAR	25	.97	55.6	1.80	68.9	2.14
200 PSI	5.6	1.29	14.0	2.34	17.3	2.84
13.8 BAR	21.2	1.29	53	2.34	65.5	2.84
250 PSI	4.9	1.65	13.4	2.91	16.5	3.48
17.2 BAR	18.5	1.65	50.7	2.91	62.4	3.48
300 PSI	4.3	1.91	12.7	3.47	15.7	4.17
20.7 BAR	16.3	1.91	48.1	3.47	59.4	4.17

- Port size: 3/4" NPT
- 1" hose barb inlet fitting for 1000 rpm operation
- Max. fluid temperature: 140°F/60°C
- Housing: Cast Iron (C), Ni-Resist (N) or Silvercast (XL)
- Shaft rotation: Counter clockwise when looking at the shaft end (clockwise available)
- Rollers: Super Rollers standard [Poly (T3) and Teflon® (T2)]
- Shaft Seals: Viton® standard
- Available PTO adapters: See Page 72
- Recommended PTO torque arm kit 3430-0540
- Rotor: Cast Iron, Ni-Resist or Silvercast
- Weight: 9 lbs./4.1 kg

### Order Information

Model Number	Max GPM	Max LPM	Max PSI	Max BAR	Max RPM	Shaft Output		
						U.S.	Metric	Shaft
6500C	21.8	82.5	300	20.7	1200	5/8"	15.9 mm	solid
6500N	21.8	82.5	300	20.7	1200	5/8"	15.9 mm	solid
6500XL	21.8	82.5	300	20.7	1200	5/8"	15.9 mm	solid

Teflon® rollers - Add Suffix "T2" - (i.e.: 6500C-T2).  
 Polypropylene rollers - Add Suffix "T3" - (i.e.: 6500C-T3).  
 Reverse rotation\* - Add Suffix "R" - (i.e.: 6500C-R).

# Cast Iron, Ni-Resist or Silver Series XL

## Series 7560 8-Roller



Pressure in PSI and BAR	GPM	HP	GPM	HP	GPM	HP
	LPM	HP	LPM	HP	LPM	HP
	@540 RPM		@800 RPM		@1000 RPM	
0 PSI	12	.33	18.3	.89	22.5	1.56
0 BAR	45.4	.33	69.3	.89	85.2	1.56
50 PSI	11.1	.74	17.5	1.26	22	1.78
3.4 BAR	42	.74	66.2	1.26	83.3	1.78
100 PSI	10.3	1.25	16.9	1.95	21.3	2.53
6.9 BAR	39	1.25	64	1.95	80.6	2.53
150 PSI	9.5	1.77	16.1	2.65	20.6	3.5
10.3 BAR	36	1.77	60.9	2.65	78	3.5
200 PSI	8.6	2.26	15.5	3.4	20	4.2
13.8 BAR	32.5	2.26	58.7	3.4	75.7	4.2
250 PSI	7.0	2.78	14.5	4.2	18.9	5.3
17.2 BAR	29.5	2.78	54.9	4.2	71.5	5.3
300 PSI	7.1	3.3	18.9	5.3	18.0	6.1
20.7 BAR	26.9	3.3	51.9	5.3	68.1	6.1

- Max. fluid temperature: 140°F/60°C
- Port sizes: 3/4" NPT
- 1" hose barb inlet fitting for 1000 rpm operation
- Housing: Cast Iron (C), Ni-Resist (N) or Silvercast (XL)
- Shaft rotation: Counter clockwise when looking at the shaft end (clockwise available)
- Rollers: Super Rollers standard [Poly (T3) and Teflon® (T2)]
- Shaft Seals: Viton® standard
- Available PTO adapters: See Page 72
- Recommended PTO torque arm kit 3430-0540
- Rotor: Cast Iron, Ni-Resist or Silvercast
- Weight: 13 lbs./5.89 kg

### Order Information

Model Number	Max GPM	Max LPM	Max PSI	Max BAR	Max RPM	Shaft Output		
						U.S.	Metric	Shaft
7560C	22.5	85.2	300	26.7	1000	15/16"	23.8 mm	solid
7560N	22.5	85.2	300	26.7	1000	15/16"	23.8 mm	solid
7560XL	22.5	85.2	300	26.7	1000	15/16"	23.8 mm	solid

Teflon® rollers - Add Suffix "T2" - (i.e.: 7560C-T2).  
 Polypropylene rollers - Add Suffix "T3" - (i.e.: 7560C-T3).  
 Reverse rotation\* - Add Suffix "R" - (i.e.: 7560C-R).

Teflon® is a registered trademark of E.I. DuPont de Nemours and Co.  
 Viton® is a registered trademark of DuPont. Hypro® is a registered trademark of Pentair.

# Hydraulically-Driven Cast Iron, Ni-Resist or Silver Series

## Series 7560-GM30, 7560-GM15 8-Roller



- Hydraulic motor drive (for open center, closed center and load-sensing systems)
- Max. fluid temperature: 140°F/60°C
- Pump port size: 3/4" NPT
- 1" hose barb inlet fitting for 1000 rpm operation
- Housing: Cast Iron (C), Ni-Resist (N) or Silvercast (XL)
- Rollers: Super Rollers standard [Poly (T3) and Teflon® (T2)]
- Shaft Seals: Viton® standard
- Rotor: Cast Iron, Ni-Resist or Silvercast
- Motor port size: -10 SAE (7/8" - 14" UNF)

### Order Information

Model Number	Max GPM	Max LPM	Max PSI	Max BAR	Max RPM	Motor Capacity Hydraulic Flow Max	
						US	Metric
7560C-GM30	20.8	78.7	300	20.7	1000	12 gpm	45 lpm
7560N-GM30	20.8	78.7	300	20.7	1000	12 gpm	45 lpm
7560XL-GM30	20.8	78.7	300	20.7	1000	12 gpm	45 lpm
7560C-GM15	20.1	76.1	300	20.7	1000	6 gpm	23 lpm
7560N-GM15	20.1	76.1	300	20.7	1000	6 gpm	23 lpm
7560XL-GM15	20.1	76.1	300	20.7	1000	6 gpm	23 lpm

Teflon® rollers - Add Suffix "T2" - (i.e.: 7560C-GM30-T2).

Polypropylene rollers - Add Suffix "T3" - (i.e.: 7560C-GM30-T3).

### 7560C,N,XL-GM15

### U.S. Units

Hyd.GPM	GPM at									
	0 PSI	25 PSI	50 PSI	75 PSI	100 PSI	125 PSI	150 PSI	200 PSI	250 PSI	300 PSI
3	10.6	9.4	8.5	7.7	7.1	6.5	5.8	4.8	3.2	1.6
4	14.1	13.1	12.0	11.3	10.6	10.0	9.3	8.3	6.9	5.2
5	17.4	16.6	15.7	15.0	14.4	13.5	13.2	11.8	10.3	8.7
6	20.8	20.1	19.4	18.6	17.9	17.1	16.5	14.9	13.3	11.8

### 7560C,N,XL-GM15

### Metric Units

Hyd.LPM	LPM at									
	0 Bar	1.7 Bar	3.5 Bar	5.2 Bar	6.9 Bar	8.6 Bar	10.3 Bar	13.8 Bar	17.2 Bar	20.7 Bar
11.4	40.1	35.6	32.2	29.1	26.9	24.6	22.0	18.2	12.1	6.1
15.1	53.4	49.6	45.4	42.8	40.1	37.9	35.2	31.4	26.1	19.7
18.9	65.9	62.8	59.4	56.8	54.5	51.1	50.0	44.7	39.0	32.9
22.7	78.7	76.1	73.4	70.4	67.8	64.7	62.5	56.4	50.3	44.7

### 7560C,N,XL-GM30

### U.S. Units

Hyd. GPM	GPM at									
	0 PSI	25 PSI	50 PSI	77 PSI	100 PSI	125 PSI	150 PSI	200 PSI	250 PSI	300 PSI
5	9.0	8.5	7.8	7.3	6.7	6.1	5.5	4.4	3.3	2.2
6	10.5	10.0	9.5	8.9	8.4	7.8	7.3	6.2	5.2	4.1
7	11.9	11.5	11.0	10.4	9.9	9.4	8.9	7.8	6.8	5.7
8	13.7	13.1	12.5	12.0	11.5	10.9	10.4	9.4	8.4	7.3
9	15.2	14.6	14.1	13.6	13.1	12.6	12.1	11.1	10.0	9.1
10	16.9	16.5	15.9	15.4	14.9	14.3	13.9	12.9	11.9	11.0
11	18.6	18.2	17.6	17.1	16.6	16.1	15.6	14.7	13.8	12.9
12	20.1	19.6	19.1	18.6	18.1	17.6	17.1	16.3	15.3	14.5

### 7560C,N,XL-GM30

### Metric Units

Hyd. LPM	LPM at										
	0 BAR	2 BAR	4 BAR	6 BAR	8 BAR	10 BAR	12 BAR	14 BAR	16 BAR	18 BAR	20 BAR
20	35.8	33.2	30.5	28.1	25.6	23.4	20.9	18.5	15.8	12.6	10.0
25	42.8	39.5	36.8	34.0	31.8	29.2	26.2	23.7	21.6	18.9	16.4
30	51.8	49.0	45.8	43.0	40.3	37.9	35.3	33.3	31.1	28.9	26.2
35	58.1	55.8	52.7	50.1	47.7	45.5	43.1	40.9	38.8	36.3	33.5
40	67.6	64.8	62.4	60.0	57.7	55.8	53.4	51.3	48.8	46.6	44.1
45	75.3	72.7	70.4	68.1	66.0	63.8	61.8	59.8	57.8	55.7	53.3

Teflon® is a registered trademark of E.I. DuPont de Nemours and Co.

Viton® is a registered trademark of DuPont. Hypro® is a registered trademark of Pentair Ltd.

# Cast Iron, Ni-Resist or Silver Series XL

## Series 7700 7-Roller



- Max. fluid temperature: 140°F/60°C
- Port size: 3/4" NPT
- Housing: Cast Iron (C), Ni-Resist (N) or Silvercast (XL)
- Shaft rotation: Counter clockwise when looking at the shaft end (Clockwise available)
- Rollers: Super Rollers standard [Poly (T3) and Teflon® (T2)]
- Shaft Seals: Viton® standard
- Available PTO adapters: See Page 72
- Recommended PTO torque arm kit 3430-0540
- Rotor: Cast Iron, Ni-Resist or Silvercast
- Weight: 14 lbs./6.36 kg

Pressure in PSI and BAR	GPM		HP		GPM		HP	
	LPM	HP	LPM	HP	LPM	HP	LPM	HP
	@540 RPM		@600 RPM		@800 RPM			
0 PSI	14.2	.23	15.3	.28	22.1	.37		
0 BAR	53.7	.23	57.9	.28	83.6	.37		
50 PSI	12.9	.56	14.0	.62	20.7	.86		
3.4 BAR	48.8	.56	53	.62	78.3	.86		
100 PSI	11.9	1.10	13.0	1.20	19.5	1.66		
6.9 BAR	45	1.10	49.2	1.20	73.8	1.66		
150 PSI	11.2	1.64	12.3	1.80	18.6	2.40		
10.3 BAR	42.4	1.64	46.6	1.80	70.4	2.40		
200 PSI	10.3	2.22	11.6	2.44	17.8	3.26		
13.8 BAR	39	2.22	43.9	2.44	67.4	3.26		

### Order Information

Model Number	Max GPM	Max LPM	Max PSI	Max BAR	Max RPM	Shaft Output		
						U.S.	Metric	Shaft
7700C	22.1	83.7	200	13.8	800	15/16"	23.8 mm	solid
7700N	22.1	83.7	200	13.8	800	15/16"	23.8 mm	solid
7700XL	22.1	83.7	200	13.8	800	15/16"	23.8 mm	solid

Teflon® rollers - Add Suffix "T2" - (i.e.: 7700C-T2).  
 Polypropylene rollers - Add Suffix "T3" - (i.e.: 7700C-T3).  
 Reverse rotation\* - Add Suffix "R" - (i.e.: 7700C-R).

# Cast Iron, Ni-Resist or Silver Series XL

## Series 1700 5-Roller



- Max. fluid temperature: 140°F/60°C
- Port size: 1" NPT (BSP available on 1700C)
- Housing: Cast Iron (C), Ni-Resist (N) or Silvercast (XL)
- Shaft rotation: Counter clockwise when looking at the shaft end (Clockwise available)
- Rollers: Super Rollers standard [Poly (T3) and Teflon® (T2) available]
- Shaft Seals: Viton® standard
- Available PTO adapters (forged steel recommended): See Page 72
- Recommended PTO torque arm kit 3430-0540
- Rotor: Cast Iron, Ni-Resist or Silvercast
- Weight: 19 lbs./8.6 kg

Pressure in PSI and BAR	GPM		HP		GPM		HP	
	LPM	HP	LPM	HP	LPM	HP	LPM	HP
	@540 RPM		@600 RPM		@1000 RPM			
0 PSI	25.0	2.7	28.0	.34	45.0	1.42		
0 BAR	94.6	2.7	106	.34	170	1.42		
50 PSI	21.0	1.18	24.5	1.39	43.0	3.0		
3.4 BAR	79.5	1.18	92.7	1.39	163	3.0		
100 PSI	19.0	2.13	22.0	2.36	41.0	4.67		
6.9 BAR	71.9	2.13	83.3	2.36	155	4.67		
150 PSI	17.0	2.89	20.0	3.34	39.0	6.07		
10.3 BAR	64.3	2.89	75.7	3.34	148	6.07		
200 PSI	15.0	3.85	18.0	4.39	----	----		
13.8 BAR	56.8	3.85	681	4.39	----	----		

### Order Information

Model Number	Max GPM	Max LPM	Max PSI	Max BAR	Max RPM	Shaft Output		
						U.S.	Metric	Shaft
1700C*	45	170	200	13.8	1000	15/16"	23.8 mm	solid
1700N	45	170	200	13.8	1000	15/16"	23.8 mm	solid
1700XL	45	170	200	13.8	1000	15/16"	23.8 mm	solid

\* BSP Version - 1700C-BT  
 Teflon® rollers - Add Suffix "T2" - (i.e.: 1700C-T2).  
 Polypropylene rollers - Add Suffix "T3" - (i.e.: 1700C-T3).  
 Reverse rotation\* - Add Suffix "R" - (i.e.: 1700C-R).

Teflon® is a registered trademark of E.I. DuPont de Nemours and Co.  
 Viton® is a registered trademark of DuPont. Hypro® is a registered trademark of Pentair.

# Cast Iron, Ni-Resist or Silver Series XL

## Series 1502 6-Roller



- Max. fluid temperature: 140°F/60°C
- Port size: 1-1/2" NPT (BSP available on 1502C)
- Housing: Cast Iron (C), Ni-Resist (N) or Silvercast (XL)
- Shaft rotation: Counter clockwise when looking at the shaft end (Clockwise available)
- Rollers: Super rollers standard [Poly (T3) available]
- Shaft Seals: Buna-N standard on Cast Iron and Ni-Resist [Viton (Q) available]; Viton® standard on Silver Series XL
- Available PTO adapters (forged steel recommended): See Page 72
- Recommended PTO Torque Arm Kit 3430-0540
- Rotor: Cast Iron, Ni-Resist or Silvercast
- Weight: 30 lbs./13.6 kg

Pressure in PSI and BAR	GPM	HP	GPM	HP	GPM	HP
	LPM	HP	LPM	HP	LPM	HP
	@540 RPM		@600 RPM		@1000 RPM	
0 PSI	33.1	.51	36.8	.66	62.1	2.02
0 BAR	125	.51	139	.66	235	2.02
25 PSI	29.7	1.02	33.6	1.15	58.5	3.04
1.7 BAR	112	1.02	127	1.15	221	3.04
50 PSI	27.8	1.45	31.7	1.68	56.9	3.69
3.4 BAR	105	1.45	120	1.68	215	3.69
100 PSI	24.3	2.46	28.3	2.78	53.9	5.31
6.9 BAR	92	2.46	107	2.78	204	5.31
150 PSI	21.0	3.54	25.0	3.95	50.9	7.12
10.3 BAR	79.5	3.54	94.6	3.95	193	7.12

### Order Information

Model Number	Max GPM	Max LPM	Max PSI	Max BAR	Max RPM	Shaft Output		
						U.S.	Metric	Shaft
1502C*	62	235	200	13.8	1000	15/16"	23.8 mm	solid
1502N	62	235	200	13.8	1000	15/16"	23.8 mm	solid
1502XL	62	235	200	13.8	1000	15/16"	23.8 mm	solid

\*BSP Version - 1502C-BT  
 Teflon® rollers - Add Suffix "T2" - (i.e.: 1502C-T2).  
 Polypropylene rollers - Add Suffix "T3" - (i.e.: 1502C-T3).  
 Reverse rotation\* - Add Suffix "R" - (i.e.: 1502C-R).

# Cast Iron or Silver Series XL, Gas Engine Driven

## Models: 4101C-25, 4101XL-25



- 2.5 HP PowerPro Engine (CARB/EPA approved)
- Port size: 3/4" NPT
- Housing: Cast Iron (C) or Silvercast (XL)
- Rollers: Super rollers standard [Poly (T3) and Teflon® (T2)]
- Shaft Seals: Viton® standard
- Rotor: Cast Iron (C) or Silvercast (XL)
- Weight: 29 lbs./13.1 kg

### Order Information

Model Number	Max GPM	Max LPM	Max PSI	Max BAR	Engine Mfg. & HP
4101C-25	8.9	34.7	100	6.9	PowerPro 2.5 hp
4101XL-25	8.9	34.7	150	10.3	PowerPro 2.5 hp

Pressure in PSI and BAR	GPM
BAR	LPM
0 PSI	8.9
0 BAR	34
50 PSI	8.6
3.4 BAR	33
100 PSI	8.3
6.9 BAR	31
150 PSI	8.0
10.3 BAR	30

Teflon® is a registered trademark of E.I. DuPont de Nemours and Co.  
 Viton® is a registered trademark of DuPont. Hypro® is a registered trademark of Pentair.



# Roller Pump Kits & Accessories

## Roller Pump Accessory Selection Guide

Description	Series 1500	Series 1700	Series 6500	Series 7560	Series 7700	Series 4000	Series 5200
540 rpm 1-3/8" Forged Steel PTO Adapter	1320-0076	1320-0076	1320-0077	1320-0076	1320-0076	-----	1320-0081
1000 rpm 1-3/8" Forged Steel PTO Adapter	1320-0078	1320-0078	1320-0079	1320-0078	-----	1320-0079	-----
1000 rpm 1-3/4" Forged Steel PTO Adapter	1320-0080	1320-0080	-----	1320-0080	-----	-----	-----
540 rpm 1-3/8" Forged Steel Quick Coupler	1323-0072	1323-0072	1323-0074	1323-0072	1323-0072	-----	-----
1000 rpm 1-3/8" Forged Steel Quick Coupler	1323-0073	1323-0073	1323-0075	1323-0073	-----	-----	-----
Multi-Speed 1-3/8" Forged Steel Quick Coupler	1323-0076	1323-0076	1323-0077	1323-0076	1323-0076	1323-0077	-----
Steel Shaft Adapter 3/4" x 5/8	-----	-----	1320-0015	-----	-----	1320-0015	-----
Steel Shaft Adapter 5/8" x 5/8	-----	-----	1320-0016	-----	-----	1320-0016	-----
Repair Kits	3430-0387 3430-0386	3430-0437	3430-0380	3430-0381	3430-0384	3430-0390	-----
Torque Arm Kit	-----	3430-0540	3430-0540	3430-0540	3430-0540	-----	-----
Base Kits	3420-0004	3420-0010	3420-0023	3420-0003	3420-0010	3420-0024* 3420-0025**	-----
Hydraulic Flange Kit	-----	-----	-----	3430-0636	-----	-----	-----

\* For electric motor drive 3 1/2" shaft centerline (4001, 4101).

\*\* For gas engine drive 43/16" shaft centerline (4101 only).

## Roller Repair Kits

Kit Number	Pump Series	Description	Estimated Weight Ea.	
			US Units	Metric Units
3430-0387	1502C and 1502N	Roller kit includes: 6 Super Rollers, 1 o-ring gasket, and 2 Buna-N seals	1 lb. 7 oz.	652 g
3430-0386	1502XL	Roller kit includes: 6 Super Rollers, 1 o-ring gasket, and 2 Viton® seals	1 lb. 8 oz.	680 g
3430-0437	1700	Roller kit includes: 5 Super Rollers, 1 o-ring gasket, and 2 Viton® seals	1 lb. 5 oz.	595 g
3430-0380	6500	Roller kit includes: 6 Super Rollers, 1 o-ring gasket, and 2 Viton® seals	8 oz.	227 g
3430-0381	7560/7700	Roller kit includes: 8 Super Rollers, 1 o-ring gasket, and 2 Viton® seals	12 oz.	340 g
3430-0390	4001/4101	Roller kit includes: 4 Super Rollers, 1 o-ring gasket, and 2 Viton® seals	3 oz.	85 g

## Base Kits

Kit Number	Pump Series	Description	Estimated Weight Ea.	
			US Units	Metric Units
3420-0025	4101	Base kit for mounting to gas engine, 4-3/16" shaft centerline. Base kit includes: 1 Base, 2 Bolts and 2 Lock washers	12 oz.	340 g
3420-0024	4001/4101	Base kit for mounting to an electric motor, 3-1/2" shaft centerline. Base kit includes: 1 Base, 2 Bolts and 2 Lock washers	7 oz.	198 g
3420-0023	6500	Base kit includes: 1 Base, 2 Bolts and 2 Lock washers	12 oz.	340 g
3420-0003	7560	Base kit includes: 1 Base, 3 Bolts and 3 Lock washers	1 lb. 10 oz.	737 g
3420-0010	7700/1700	Base kit includes: 1 Base and 4 Bolts	14 oz.	397 g
3420-0004	1500	Base kit includes: 1 Base and 4 Bolts	6 lbs.	2.7 kg

## Roller Pump Repair Tools and Tool Kits

Kit Number	Pump Series	Description
3011-0006	6500	Tool Kit
3011-0021	4001/4101	Tool Kit
3010-0001†	1700, 6500, 7560, 7700	Support fixture
3010-0002†	1700, 6500, 7560, 7700	Support fixture
3010-0003†	4001/4101, 6500	Bearing and seal assembly tool
3010-0004†	4001/4101, 6500	Bearing disassembly tool
3010-0005	1500, 1700, 7560, 7700	Bearing and seal assembly tool
3010-0006	1500, 1700, 7560, 7700	Bearing disassembly tool
3010-0010**	4001/4101, 6500	Bearing support tool
3010-0014**	4001/4101, 6500	Bearing race support tool
3010-0020	1500, 1700, 7560, 7700	Bearing support tool
3010-0066**	1500, 1700, 4001/4101, 6500, 7560, 7700	Wire brush
3010-0067**	1500, 1700, 4001/4101, 6500, 7560, 7700	Wire brush holder
3010-0068**	1500, 1700, 4001/4101, 6500, 7560, 7700	Tool Box
3020-0009**	1500, 1700, 4001/4101, 6500, 7560, 7700	Allen wrench; 1/16" hex

\* Included in 3011-0006 - Tool kit for 6500 series roller pumps.

† Included in 3011-0021 - Tool kit for 4001/4101 series roller pumps.

# Roller Pump Kits & Accessories

## PTO and Shaft Adapters (Female to Female)



Part Number	US	Metric	US	Metric	Material	RPM	Pump Model
	PTO (I.D.)	PTO (I.D.)	Pump End (I.D.)	Pump End (I.D.)			
1320-0015	3/4"	19 mm	5/8"	19 mm	steel	*	4000, 6500
1320-0016	5/8"	15.9 mm	5/8"	15.9 mm	steel	*	4000, 6500
1320-0054	3/4"	19 mm	15/16"	23.8 mm	die cast	*	1500, 1700, 7560, 7700
1320-0076	1-3/8" (6 spline)	34.9 mm (6 spline)	15/16"	23.8 mm	forged steel	540	1500, 1700, 7560, 7700
1320-0077	1-3/8" (6 spline)	34.9 mm (6 spline)	5/8"	34.9 mm	forged steel	540	6500
1320-0078	1-3/8" (21 spline)	34.9 mm (21 spline)	15/16"	23.8 mm	forged steel	1000	1500, 1700, 7560
1320-0079	1-3/8" (21 spline)	34.9 mm (21 spline)	5/8"	34.9 mm	forged steel	1000	4000, 6500
1320-0080	1-3/4" (20 spline)	44.5 mm (20 spline)	15/16"	23.8 mm	forged steel	1000	1500, 1700, 7560
1320-0081	1-3/8" (6 spline)	34.9 mm (6 spline)	1"	34.9 mm	forged steel	540	5200
1320-0082	1-1/2" (8 spline)	38 mm (8 spline)	15/16"	23.8 mm	forged steel	1000	1500, 1700, 7560
1320-0083	1-1/2" (8 spline)	38 mm (8 spline)	5/8"	34.9 mm	forged steel	1000	4000, 6500

\* Refer to recommended pump rpm.

## Quick Couplers (Female to Female)



Part Number	PTO (I.D.)		Pump End (I.D.)		Material	RPM	Pump Model
	US	Metric	US	Metric			
1323-0072	1-3/8" (6 spline)	34.9 mm (6 spline)	15/16"	23.8 mm	forged steel	540	1500, 1700, 7560, 7700
1323-0073	1-3/8" (21 spline)	34.9 mm (21 spline)	15/16"	23.8 mm	forged steel	1000	1500, 1700, 7560
1323-0074	1-3/8" (6 spline)	34.9 mm (6 spline)	5/8"	15.9 mm	forged steel	540	6500
1323-0075	1-3/8" (21 spline)	34.9 mm (21 spline)	5/8"	15.9 mm	forged steel	1000	4000, 6500
1323-0076*	1-3/8" (multi-speed)	34.9 mm (multi-speed)	15/16"	23.8 mm	forged steel	540/1000	1500, 1700, 7560, 7700
1323-0077*	1-3/8" (multi-speed)	34.9 mm (multi-speed)	5/8"	15.9 mm	forged steel	540/1000	4000, 6500
1323-0078	1-1/2" (8 spline)	38 mm (8 spline)	5/8"	15.9 mm	forged steel	1000	4000, 6500
1323-0079	1-1/2" (8 spline)	38 mm (8 spline)	15/16"	23.8 mm	forged steel	1000	1500, 1700, 7560

\* Multi-speed couplers are compatible with both 6 and 21 spline PTO shafts.



## Torque Arm Kit (pump not included)

Part Number	Material	RPM	For Pump Series	Estimated Weight Each	
				US Units	Metric
3430-0540	steel	540/1000	1502, 1700, 6500, 7560, and 7700	2 lbs. 4 oz.	1.02 kg

# Other Pump Accessories

## Couplers



Inches	mm
1/8"	3.2 mm
3/16"	4.7 mm
1/4"	6.4 mm
1/2"	13 mm
5/8"	15.9 mm
3/4"	19 mm
7/8"	22.2 mm
15/16"	23.8 mm
1"	25.4 mm
1-1/8"	28.6 mm

**Note:**  
These couplers are designed for inch dimensional shafts and keys. Metric dimensions are for reference only (except for 2739-1009).

Series	Part Number	Description	Estimated Weight Each	
			US Units	Metric
2738 (2.0 hp limit)* Replaces L-075	2738-1001	1/2" coupling end, with 1/8" keyway	6 oz.	170 g
	2738-1002	5/8" coupling end, with 3/16" keyway	6 oz.	170 g
	2738-1003	3/4" coupling end, with 3/16" keyway	6 oz.	170 g
	2738-1004	7/8" coupling end, with 3/16" keyway	6 oz.	170 g
	2728-1001	Center disc	1 oz.	28 g
2739 (5.0 hp limit)* Replaces L-095	2739-1001	5/8" coupling end, with 3/16" keyway	11 oz.	312 g
	2739-1002	3/4" coupling end, with 3/16" keyway	11 oz.	312 g
	2739-1003	7/8" coupling end, with 3/16" keyway	11 oz.	312 g
	2739-1004	15/16" coupling end, with 1/4" keyway	11 oz.	312 g
	2739-1005	1" coupling end, with 1/4" keyway	11 oz.	312 g
	2739-1006	1-1/8" coupling end, with 1/4" keyway	11 oz.	312 g
	2739-1009	24 mm coupling end, with 8mm keyway	11 oz.	312 g
	2729-1001	Center disc	1 oz.	28 g
	2729-1005	Heavy-duty center disc, urethane material	1 oz.	28 g
2741 (10.5 hp limit)* Replaces L-100	2741-1001	3/4" coupling end, with 3/16" keyway	1 lb. 5 oz.	595 g
	2741-1004	15/16" coupling end, with 1/4" keyway	1 lb. 5 oz.	595 g
	2741-1002	1" coupling end, with 1/4" keyway	1 lb. 5 oz.	595 g
	2741-1005	1-1/4" coupling end, with 1/4" keyway	1 lb. 5 oz.	595 g
	2741-1007	1-3/8" coupling end, with 5/16" keyway	1 lb. 5 oz.	595 g
	2741-1003	1-1/8" coupling end, with 1/4" keyway	1 lb. 5 oz.	595 g
	2729-1002	Center disc	1 oz.	28 g
	2729-1006	heavy-duty center disc, urethane material	1 oz.	28g
2740 (18.0 hp limit)* Replaces L-110	2740-1001	3/4" coupling end, with 3/16" keyway	3 lbs. 11 oz.	1.67 kg
	2740-1002	1" coupling end, with 1/4" keyway	3 lbs. 8 oz.	1.59 kg
	2740-1005	1-3/8" coupling end, with 5/16" keyway	3 lbs.	1.4 kg
	2740-1007	1-1/8" coupling end, with 1/4" keyway	2 lbs. 15 oz.	1.33 kg
	2729-1003	Center disc	3 oz.	85 g

\* HP limit is electric motor hp at 1725 rpm for driving a steady uniform load. For an uneven load, stop-start and moderate shock loads, divide hp by a 1.5 service factor.

### Ordering Instructions:

To order one 1/2" x 3/4" Series 2738 coupling, specify the following:

Note: It is not necessary to order in complete sets, parts can be ordered individually.

Quantity	Part Number	Description
1	2738-1001	1/2" coupling end
1	2738-1003	3/4" coupling end
1	2728-1001	Center disc

## Relief Valves



Part Number	Ports-NPT Inlet (M) Outlet (F)	Max. PSI	Max. BAR	Body Material	Valve Material	Estimated Weight Each	
						US Units	Metric
3300-0002	1/2" M x 1/2" F	200	14	cast bronze	stainless steel ball	10 oz.	283 g
3300-0001	3/4" M x 3/4" F	400	28	cast bronze	stainless steel ball	1 lb. 1 oz.	482 g
3301-0001	3/4" M x 3/4" F	400	28	cast bronze	flat neoprene	1 lb. 2 oz.	510 g
3300-0093	3/4" M x 3/4" F	300	20	cast bronze	stainless steel ball	1 lb. 2 oz.	510 g
3300-0094	1" M x 3/4" F	150	10	cast bronze	stainless steel ball	1 lb. 4 oz.	567 g
3316-0002	1-1/4"	200	14	cast iron	stainless steel cone	2 lbs. 14 oz.	1.3 kg
3300-0015	3/4" M - 3/4" F	150	10	nylon	nylon	6 oz.	170 g
3300-0016	3/4" M - 3/4" F	250	17	nylon	nylon	6 oz.	170 g
3300-0098	3/4" M - 3/4" F	400	28	nylon	nylon	6 oz.	170 g

# Poly Diaphragm Pump Series

## Series 9910-DP423, DP573, and DP763



- Glass-filled polypropylene construction of head, manifold and control components for the maximum in chemical resistance
- Flow rate up to 11.5 gpm (43.3 lpm), 15.6 gpm (59 lpm) and 20.2 gpm (76.5 lpm) pressure up to 290 psi (20 bar)
- 3 cylinder design eliminates the need for pulsation dampening devices and lengthens the life of the entire pumping system
- Kynar™ and 300 series stainless steel valve design for higher flow and better corrosion resistance
- The external inlet and outlet manifold design vs. an internal manifold design allows for easy valve replacement and lower cost repairs

### Order Information

Model Number	Max GPM	Max LPM	Max PSI	Max BAR	Port Size	Description
9910-DP423	11.5	43.3	290	20	1 1/4" Inlet 1" Outlet	Poly Diaphragm Pump
9910-DP423GRGI	11.5	43.3	290	20		Poly Diaphragm Pump with Gearbox and Control Unit
9910-DP573	15.6	59.1	290	20	1 1/2" Inlet 1" outlet	Poly Diaphragm Pump
9910-DP573GRGI	15.6	59.1	290	20		Poly Diaphragm Pump with Gearbox and Control Unit
9910-DP763	20.2	76.4	290	20	1 1/2" Inlet 1" outlet	Poly Diaphragm Pump
9910-DP763GRGI	20.2	76.4	290	20		Poly Diaphragm Pump with Gearbox and Control Unit
9910-GS25	Control Unit (DP 423)					
9910-GS35S	Control Unit (DP573 & DP763)					

### DP423

Pressure in PSI and BAR	GPM		HP		GPM		HP		GPM		HP	
	LPM	HP	LPM	HP	LPM	HP	LPM	HP	LPM	HP	LPM	HP
	@350 RPM		@400 RPM		@450 RPM		@500 RPM		@550 RPM			
<b>0 PSI</b>	7.5	0.18	8.5	0.20	9.4	0.29	10.5	0.35	11.5	0.42		
<b>0 BAR</b>	28.3	0.18	32.2	0.20	35.6	0.29	39.5	0.35	43.3	0.42		
<b>72 PSI</b>	7.3	0.46	8.3	0.53	9.2	0.61	10.2	0.68	11.0	0.77		
<b>5 BAR</b>	27.4	0.46	31.2	0.53	34.6	0.61	38.5	0.68	41.5	0.77		
<b>145 PSI</b>	7.2	0.77	8.2	0.87	9.1	0.98	10.1	1.11	11.0	1.21		
<b>10 BAR</b>	27.3	0.77	31.1	0.87	34.5	0.98	38.2	1.11	41.4	1.21		
<b>217 PSI</b>	7.0	1.06	8.1	1.21	9.1	1.37	10.0	1.51	10.8	1.68		
<b>15 BAR</b>	26.5	1.06	30.5	1.21	34.5	1.37	37.7	1.51	40.7	1.68		
<b>290 PSI</b>	6.9	1.33	7.8	1.53	9.1	1.74	9.8	1.93	10.6	2.14		
<b>20 BAR</b>	26.0	1.33	29.5	1.53	34.2	1.74	37.0	1.93	40.1	2.14		

### DP573

Pressure in PSI and BAR	GPM		HP		GPM		HP		GPM		HP	
	LPM	HP	LPM	HP	LPM	HP	LPM	HP	LPM	HP	LPM	HP
	@350 RPM		@400 RPM		@450 RPM		@500 RPM		@550 RPM			
<b>0 PSI</b>	10.4	0.14	11.7	0.17	13.0	0.24	14.3	0.32	15.6	0.43		
<b>0 BAR</b>	39.5	0.10	44.3	0.13	49.1	0.18	54.3	0.24	59.1	0.32		
<b>72 PSI</b>	10.3	0.54	11.6	0.62	12.6	0.67	14.2	0.77	15.5	0.83		
<b>5 BAR</b>	39.0	0.40	43.8	0.46	47.7	0.50	53.9	0.57	58.6	0.62		
<b>145 PSI</b>	10.1	0.95	11.4	1.09	12.6	1.22	14.1	1.28	15.2	1.41		
<b>10 BAR</b>	38.4	0.71	43.0	0.81	47.6	0.91	53.3	0.95	57.5	1.05		
<b>217 PSI</b>	9.9	1.33	11.1	1.50	12.5	1.71	13.9	1.89	14.9	2.07		
<b>15 BAR</b>	37.3	0.99	41.9	1.12	47.4	1.28	52.7	1.41	56.4	1.54		
<b>290 PSI</b>	9.7	1.60	10.8	1.88	12.5	2.14	13.8	2.43	14.8	2.64		
<b>20 BAR</b>	36.8	1.19	40.9	1.40	47.3	1.60	52.3	1.81	56.1	1.97		

### DP763

Pressure in PSI and BAR	GPM		HP		GPM		HP		GPM		HP	
	LPM	HP	LPM	HP	LPM	HP	LPM	HP	LPM	HP	LPM	HP
	@350 RPM		@400 RPM		@450 RPM		@500 RPM		@550 RPM			
<b>0 PSI</b>	13.7	0.20	15.3	0.29	17.1	0.39	18.8	0.51	20.2	0.63		
<b>0 BAR</b>	51.8	0.15	57.8	0.22	64.9	0.29	71.0	0.38	76.4	0.47		
<b>72 PSI</b>	13.4	0.71	15.2	0.77	16.8	0.90	18.4	0.98	20.1	1.11		
<b>5 BAR</b>	50.9	0.53	57.6	0.57	63.5	0.67	69.8	0.73	76.0	0.83		
<b>145 PSI</b>	13.3	1.21	15.0	1.39	16.7	1.58	18.4	1.76	19.9	1.93		
<b>10 BAR</b>	50.5	0.90	56.8	1.04	63.4	1.18	69.7	1.31	75.4	1.44		
<b>217 PSI</b>	12.8	1.76	14.9	2.02	16.7	2.25	18.1	2.50	19.5	2.75		
<b>15 BAR</b>	48.5	1.31	56.3	1.51	63.1	1.68	68.6	1.86	73.9	2.05		
<b>290 PSI</b>	12.7	2.12	14.6	2.49	16.5	2.77	18.0	3.12	19.4	3.45		
<b>20 BAR</b>	48.0	1.58	55.4	1.86	62.3	2.07	68.2	2.33	73.4	2.57		

Kynar™ is a registered trademark of Arkema, Inc.  
Hypro® is a registered trademark of Pentair.

# Low Pressure, 2 Diaphragm

## Model 9910-D70 and D70GR



- Max. fluid temperature: 140°F/60°C
- Port sizes: 1-1/4" inlet, 1" outlet, hose barb
- Diaphragms: 2, semi-hydraulic, Desmopan® standard, Buna available
- Housing components for liquid handling: epoxy-coated
- Pump shaft rotation: CW and CCW
- For shaft kits and other drive options, see pages 86-87.
- Recommended control unit: 3300-0087 or 3300-0088, see page 88.
- Weight: 22 lbs./10 kg (D70); 31 lbs./14 kg (D70GR)

Pressure in PSI and BAR	GPM		HP		GPM		HP		GPM		HP	
	LPM	HP	LPM	HP	LPM	HP	LPM	HP	LPM	HP	LPM	HP
	@350 RPM		@400 RPM		@450 RPM		@500 RPM		@550 RPM			
<b>0 PSI</b>	13.6	0.33	15.1	0.40	16.9	0.48	18.4	0.58	19.6	0.80		
<b>0 BAR</b>	51.2	0.33	57.1	0.40	63.7	0.48	69.4	0.58	74.1	0.80		
<b>72 PSI</b>	11.2	0.73	12.7	0.79	14.1	0.91	15.6	1.01	17.0	1.09		
<b>5 BAR</b>	42.3	0.73	47.9	0.79	53.2	0.91	58.8	1.01	64.3	1.09		
<b>145 PSI</b>	11.0	1.20	12.4	1.39	13.9	1.63	15.2	1.66	16.6	1.91		
<b>10 BAR</b>	41.4	1.20	46.9	1.39	52.6	1.63	57.3	1.66	62.7	1.91		
<b>217 PSI</b>	10.7	1.71	12.3	2.10	13.8	2.19	15.1	2.36	16.3	2.63		
<b>15 BAR</b>	40.4	1.71	46.3	2.10	52.2	2.19	57.1	2.36	61.6	2.63		
<b>290 PSI</b>	10.6	2.18	12.1	2.46	13.7	2.77	15.0	3.12	16.1	3.39		
<b>20 BAR</b>	40.0	2.18	45.7	2.46	51.8	2.77	56.7	3.12	60.6	3.39		

All HP requirements listed in the table are electrical.  
For approximate gasoline equivalent, multiply by 1.3.

### Order Information

Model Number	Max GPM	Max LPM	Max PSI	Max BAR	Max RPM	Shaft Output
9910-D70	19.6	74.2	290	20	550	Select shaft kit for desired drive
9910-D70GR	19.6	74.2	290	20	3600	3/4" hollow shaft w/ gear reduction for 5 hp gas engine

# Low Pressure, 3 Diaphragm

## Model 9910-D115 and D115GR34



- Max. fluid temperature: 140°F/60°C
- Port sizes: 1-1/2" inlet, 1" outlet, hose barb
- Diaphragms: 3, semi-hydraulic, Desmopan® standard, Buna available
- Housing components for liquid handling: epoxy-coated
- Pump shaft rotation: CW and CCW
- For shaft kits and other drive options, see pages 86-87.
- Recommended control unit: 3300-0087 or 3300-0088, see page 88.
- Weight: 35 lbs./15.9 kg (D115); 44 lbs. /20 kg (D115GR34)

Pressure in PSI and BAR	GPM		HP		GPM		HP		GPM		HP	
	LPM	HP	LPM	HP	LPM	HP	LPM	HP	LPM	HP	LPM	HP
	@350 RPM		@400 RPM		@450 RPM		@500 RPM		@550 RPM			
<b>0 PSI</b>	18.9	0.33	21.4	0.40	23.9	0.45	26.4	0.69	28.6	0.91		
<b>0 BAR</b>	71.5	0.33	80.9	0.40	90.1	0.45	99.7	0.69	107.9	0.91		
<b>72 PSI</b>	18.6	1.13	20.7	1.18	23.4	1.40	25.5	1.62	27.9	1.83		
<b>5 BAR</b>	70.0	1.13	78.2	1.18	88.5	1.40	96.1	1.62	105.3	1.83		
<b>145 PSI</b>	18.3	1.89	20.5	2.13	23.2	2.47	25.3	2.82	27.7	2.99		
<b>10 BAR</b>	69.0	1.89	77.4	2.13	87.5	2.47	95.6	2.82	104.4	2.99		
<b>217 PSI</b>	18.2	2.72	20.4	3.11	23.1	3.51	25.1	3.88	27.6	4.33		
<b>15 BAR</b>	68.6	2.72	77.0	3.11	87.0	3.51	94.7	3.88	104.0	4.33		
<b>290 PSI</b>	18.0	3.45	20.3	3.98	22.9	4.54	25.0	5.09	27.5	5.51		
<b>20 BAR</b>	68.0	3.45	76.7	3.98	86.2	4.54	94.2	5.09	103.8	5.51		

All HP requirements listed in the table are electrical. For approximate gasoline equivalent, multiply by 1.3.  
Desmopan® is a registered trademark of Bayer Aktiengesellschaft, Farbenfabriken. Hypro® is a registered trademark of Pentair.

### Order Information

Model Number	Max GPM	Max LPM	Max PSI	Max BAR	Max RPM	Shaft Output
9910-D115	28.6	108.3	290	20	550	Select shaft kit for desired drive
9910-D115GR34	28.6	108.3	290	20	3600	3/4" hollow shaft w/ gear reduction for 5 hp gas engine

# Low Pressure, 3 Diaphragm

## Model 9910-D135



- Max. fluid temperature: 140°F/60°C
- Port sizes: 1-1/2" inlet, 1" outlet, hose barb
- Diaphragms: 3, semi-hydraulic, Desmopan® standard, Buna available
- Housing components for liquid handling: epoxy-coated
- Pump shaft rotation: CW and CCW
- Recommended control unit: 3300-0087 or 3300-0088, see page 88.
- Weight: 38 lbs./17.2 kg

### Order Information

Pressure in PSI and BAR	GPM		HP		GPM		HP		GPM		HP	
	LPM	HP	LPM	HP	LPM	HP	LPM	HP	LPM	HP	LPM	HP
	@350 RPM		@400 RPM		@450 RPM		@500 RPM		@550 RPM			
<b>0 PSI</b>	22.6	0.51	25.8	0.69	28.8	0.92	31.5	1.22	33.9	1.45		
<b>0 BAR</b>	85.4	0.51	97.3	0.69	108.8	0.92	118.8	1.22	128.0	1.45		
<b>72 PSI</b>	22.2	1.31	25.3	1.64	28.3	1.84	31.2	2.09	33.3	2.44		
<b>5 BAR</b>	83.8	1.31	95.6	1.64	106.7	1.84	117.6	2.09	125.8	2.44		
<b>145 PSI</b>	22.1	2.29	25.2	2.65	28.2	2.97	31.1	3.45	33.2	3.88		
<b>10 BAR</b>	83.4	2.29	95.2	2.65	106.3	2.97	117.2	3.45	125.3	3.88		
<b>217 PSI</b>	22.0	3.21	25.1	3.80	28.0	4.31	30.8	4.80	33.1	5.32		
<b>15 BAR</b>	83.0	3.21	94.6	3.80	105.7	4.31	116.3	4.80	124.9	5.32		
<b>290 PSI</b>	21.7	4.23	24.8	4.88	27.9	5.45	30.7	6.21	33.0	6.84		
<b>20 BAR</b>	81.9	4.23	93.4	4.88	105.3	5.45	115.7	6.21	124.6	6.84		

Model Number	Max GPM	Max LPM	Max PSI	Max BAR	Max RPM	Shaft Output
9910-D135	33.9	128.3	290	20	550	1-3/8" - 6 splined male shaft

All HP requirements listed in the table are electrical. For approximate gasoline equivalent, multiply by 1.3.

# Low Pressure, 4 Diaphragm

## Model 9910-D160



- Max. fluid temperature: 140°F/60°C
- Port sizes: 2" inlet, 1-1/2" outlet, hose barb
- Diaphragms: 4, semi-hydraulic, Desmopan® standard, Buna available
- Housing components for liquid handling: epoxy-coated
- Pump shaft rotation: CW and CCW
- For hydraulic drive adaption, see page 87.
- Recommended control unit: 3300-0087 or 3300-0088, see page 88.
- Weight: 66 lbs./30 kg

### Order Information

Pressure in PSI and BAR	GPM		HP		GPM		HP		GPM		HP	
	LPM	HP	LPM	HP	LPM	HP	LPM	HP	LPM	HP	LPM	HP
	@350 RPM		@400 RPM		@450 RPM		@500 RPM		@550 RPM			
<b>0 PSI</b>	27.9	0.61	32.1	0.80	35.1	1.03	38.9	1.33	41.9	1.68		
<b>0 BAR</b>	105.3	0.61	121.0	0.80	132.3	1.03	146.6	1.33	158.1	1.68		
<b>72 PSI</b>	26.4	1.51	30.0	1.73	33.6	2.01	37.1	2.18	40.9	2.50		
<b>5 BAR</b>	99.7	1.51	113.1	1.73	127.0	2.01	139.9	2.18	154.2	2.50		
<b>145 PSI</b>	25.4	2.48	28.7	2.91	32.6	3.28	35.7	3.74	38.9	4.13		
<b>10 BAR</b>	95.7	2.48	108.5	2.91	122.9	3.28	134.8	3.74	146.8	4.13		
<b>217 PSI</b>	24.3	3.45	27.7	4.06	31.0	4.58	34.4	5.13	37.6	5.73		
<b>15 BAR</b>	91.8	3.45	104.5	4.06	117.0	4.58	129.8	5.13	141.9	5.73		
<b>290 PSI</b>	23.6	4.50	26.9	5.18	30.2	5.86	33.7	6.45	36.8	7.26		
<b>20 BAR</b>	89.1	4.50	101.6	5.18	114.1	5.86	127.0	6.45	138.9	7.26		

Model Number	Max GPM	Max LPM	Max PSI	Max BAR	Max RPM	Shaft Output
9910-D160	41.9	155.1	290	20	550	1-3/8" - 6 splined male shaft

All HP requirements listed in the table are electrical. For approximate gasoline equivalent, multiply by 1.3. Desmopan® is a registered trademark of Bayer Aktiengesellschaft, Farbenfabriken. Hypro® is a registered trademark of Pentair.

# Low Pressure, 6 Diaphragm

## Model 9910-D250



- Max. fluid temperature: 140°F/60°C
- Port sizes: 2" inlet, 1-1/2" outlet, hose barb
- Diaphragms: 6, semi-hydraulic, Desmopan® standard, Buna available
- Housing components for liquid handling: epoxy-coated
- Mounting base: included
- Pump shaft rotation: CW and CCW
- For hydraulic drive adaption, see page 87.
- Recommended control unit: 3300-0082, see page 88.
- Weight: 92 lbs./41.7 kg

### Order Information

Pressure in PSI and BAR	GPM		HP		GPM		HP		GPM		HP	
	LPM	HP	LPM	HP	LPM	HP	LPM	HP	LPM	HP	LPM	HP
	@350 RPM		@400 RPM		@450 RPM		@500 RPM		@550 RPM			
<b>0 PSI</b>	42.7	0.71	48.3	0.90	54.3	1.22	59.8	1.60	65.7	2.01		
<b>0 BAR</b>	161.2	0.71	182.5	0.90	204.8	1.22	225.7	1.60	248.1	2.01		
<b>72 PSI</b>	41.4	2.33	47.2	2.73	52.7	3.10	58.1	3.45	63.3	3.88		
<b>5 BAR</b>	156.1	2.33	178.2	2.73	198.9	3.10	219.4	3.45	239.0	3.88		
<b>145 PSI</b>	40.1	4.09	45.9	4.73	52.1	5.27	56.6	6.02	61.3	6.45		
<b>10 BAR</b>	151.4	4.09	173.1	4.73	196.4	5.27	213.8	6.02	231.2	6.45		
<b>217 PSI</b>	39.3	5.70	45.1	6.58	50.7	7.45	55.5	8.32	60.2	9.22		
<b>15 BAR</b>	148.5	5.70	170.0	6.58	191.5	7.45	209.5	8.32	227.1	9.22		
<b>290 PSI</b>	38.8	7.52	44.5	8.45	50.1	9.66	54.8	10.89	59.2	11.54		
<b>20 BAR</b>	146.4	7.52	167.9	8.45	189.0	9.66	206.9	10.89	223.4	11.54		

Model Number	Max GPM	Max LPM	Max PSI	Max BAR	Max RPM	Shaft Output
9910-D250	65.7	248.7	290	20	550	1-3/8" - 6 splined male shaft

All HP requirements listed in the table are electrical. For approximate gasoline equivalent, multiply by 1.3.

# Medium Pressure, 2 Diaphragm

## Model 9910-D252, D252GRGI, D252GRGI58 and D252GRGIAP



- Max. fluid temperature: 140°F/60°C
- Diaphragms: 2, semi-hydraulic, Desmopan® standard, Buna available
- Housing: anodized aluminum
- Mounting base: included
- Recommended control unit: 9910-KIT1990, see page 88.
- Weight: 14 lbs./6.4 kg (GRGI models); 12 lbs./5.4 kg (D252)

### Order Information

Pressure in PSI and BAR	GPM		HP		GPM		HP		GPM		HP	
	LPM	HP	LPM	HP	LPM	HP	LPM	HP	LPM	HP	LPM	HP
	@450 RPM		@500 RPM		@550 RPM		@600 RPM		@650 RPM			
<b>0 PSI</b>	4.8	0.15	5.4	0.19	5.9	0.23	6.1	0.25	6.5	0.27		
<b>0 BAR</b>	18.0	0.15	20.5	0.19	22.4	0.23	23.1	0.25	24.6	0.27		
<b>72 PSI</b>	4.1	0.33	4.6	0.37	5.0	0.42	5.5	0.45	5.9	0.46		
<b>5 BAR</b>	15.3	0.33	17.3	0.37	18.7	0.42	20.8	0.45	22.2	0.46		
<b>145 PSI</b>	4.0	0.49	4.4	0.57	4.8	0.64	5.3	0.65	5.6	0.72		
<b>10 BAR</b>	14.9	0.49	16.6	0.57	18.1	0.64	19.8	0.65	21.3	0.72		
<b>217 PSI</b>	3.9	0.66	4.3	0.76	4.7	0.82	5.2	0.89	5.5	0.97		
<b>15 BAR</b>	14.7	0.66	16.4	0.76	17.9	0.82	19.6	0.89	20.9	0.97		
<b>290 PSI</b>	3.8	0.84	4.2	0.94	4.6	1.02	5.1	1.12	5.4	1.21		
<b>20 BAR</b>	14.5	0.84	16.0	0.94	17.4	1.02	19.4	1.12	20.5	1.21		

Model Number	Max GPM	Max LPM	Max PSI	Max BAR	Max RPM	Port Size	Shaft Output
9910-D252	6.5	24.6	290	20	650	3/4" HB inlet, 1/2" HB outlet	3/4" solid keyed shaft
9910-D252GRGI	6.5	24.6	290	20	3600	3/4" HB inlet, 3/8" HB outlet	3/4" hollow shaft
9910-D252GRGI58	5.5	20.8	290	20	3600	3/4" HB inlet, 3/8" HB outlet	5/8" hollow shaft
9910-D252GRGIAP	6.5	24.6	290	20	3600	3/4" HB inlet, 3/8" HB outlet	3/4" hollow input shaft with 5/8" output solid shaft

All HP requirements listed in the table are electrical. For approximate gasoline equivalent, multiply by 1.3. Desmopan® is a registered trademark of Bayer Aktiengesellschaft, Farbenfabriken. Hypro® is a registered trademark of Pentair.

# Medium Pressure, 2 Diaphragm

Model 9910-D30, D30AP-A, D30GRGI and D30-B-GRGI



- Max. fluid temperature: 140°F/60°C
- Shaft: flanged for shaft kit (D30); flanged w/ 3/4" shaft ext. (D30AP-A); 3/4" hollow shaft for gas engine mount (D30GRGI)
- Diaphragms: 2, semi-hydraulic, Desmopan® standard, Buna available
- Housing components for liquid handling: epoxy-coated
- Pump shaft rotation: CW and CCW
- For shaft kits and other drive options, see pages 86-87.
- Recommended control unit: 9910-GS40GI, see page 87.
- Weight: 23 lbs./10.4 kg (D30); 33 lbs./15.0 kg (D30GRGI and D30-B-GRGI); 24 lbs./10.9 kg (D30AP-A)

Pressure in PSI and BAR	GPM		HP		GPM		HP		GPM		HP	
	LPM	HP	LPM	HP	LPM	HP	LPM	HP	LPM	HP	LPM	HP
	@350 RPM		@400 RPM		@450 RPM		@500 RPM		@550 RPM			
0 PSI	6.1	0.13	6.9	0.16	7.8	0.19	8.7	0.24	9.6	0.28		
0 BAR	23.0	0.13	26.1	0.16	29.5	0.19	32.8	0.24	36.2	0.28		
145 PSI	5.7	0.55	6.6	0.66	7.2	0.76	8.1	0.85	9.3	0.90		
10 BAR	21.4	0.55	24.9	0.66	27.3	0.76	30.6	0.85	34.9	0.90		
290 PSI	5.6	1.00	6.3	1.14	7.1	1.29	7.8	1.47	8.8	1.64		
20 BAR	21.0	1.00	23.7	1.14	26.7	1.29	29.5	1.47	33.4	1.64		
465 PSI	5.5	1.46	5.9	1.67	6.9	1.89	7.7	2.06	8.6	2.27		
30 BAR	20.6	1.46	22.4	1.67	26.0	1.89	29.0	2.06	32.5	2.27		
580 PSI	5.2	1.90	5.8	2.11	6.8	2.41	7.5	2.71	8.3	2.94		
40 BAR	19.5	1.90	22.1	2.11	25.8	2.41	28.2	2.71	31.4	2.94		

All HP requirements listed in the table are electrical.  
For approximate gasoline equivalent, multiply by 1.3.

## Order Information

Model Number	Max GPM	Max LPM	Max PSI	Max BAR	Max RPM	Port Size
9910-D30	9.6	36.3	580	40	550	1" HB inlet, 1/2" HB outlet
9910-D30AP-A	Same pump as 9910-D30 with 3/4" solid thru shaft					
9910-D30GRGI	9.6	36.3	580	40	3600	Assembled with gearbox 9910-KIT1640 and control 9910-GS40GI for mounting on 5 hp gas engine
9910-D30-B-GRGI	Same pump as 9910-D30GRGI with Buna-N diaphragms					
D30HRGI	9.6	36.3	580	40	3600	Assembled with gearbox 8000-0056 and control 9910-GS40GI for mounting on 5 hp gas engine

# Medium Pressure, 3 Diaphragm

Model 9910-D403, and D403GRGI



- Max. fluid temperature: 140°F/60°C
- Shaft: flanged for kit attachment (D403); 3/4" hollow shaft for gas engine mount (D403GRGI)
- Diaphragms: 3, semi-hydraulic, Desmopan® standard, Buna available
- Housing: anodized aluminum
- Mounting base: included
- For shaft kits and other drive options, see pages 86-87.
- Recommended control unit: 9910-GR40, see page 88.
- Weight: 23 lbs./10.4 kg (D403); 32 lbs./14.5 kg (D403GRGI)

Pressure in PSI and BAR	GPM		HP		GPM		HP		GPM		HP	
	LPM	HP	LPM	HP	LPM	HP	LPM	HP	LPM	HP	LPM	HP
	@350 RPM		@400 RPM		@450 RPM		@500 RPM		@550 RPM			
0 PSI	6.3	0.22	7.3	0.33	8.0	0.41	8.9	0.54	9.9	0.61		
0 BAR	23.9	0.22	27.6	0.33	30.3	0.41	33.6	0.54	37.5	0.61		
145 PSI	6.2	0.73	7.1	0.91	7.9	1.07	8.8	1.12	9.8	1.21		
10 BAR	23.2	0.73	26.7	0.91	29.9	1.07	33.4	1.12	37.1	1.21		
290 PSI	6.1	1.21	7.0	1.41	7.8	1.63	8.7	1.82	9.7	2.03		
20 BAR	23.0	1.21	26.4	1.41	29.5	1.63	32.8	1.82	36.7	2.03		
465 PSI	6.0	1.80	6.8	2.02	7.7	2.34	8.6	2.61	9.6	2.84		
30 BAR	22.7	1.80	25.8	2.02	29.2	2.34	32.3	2.61	36.4	2.84		
580 PSI	5.9	2.36	6.7	2.65	7.6	2.91	8.4	3.30	9.5	3.62		
40 BAR	22.3	2.36	25.5	2.65	28.9	2.91	31.7	3.30	35.9	3.62		

All HP requirements listed in the table are electrical. For approximate gasoline equivalent, multiply by 1.3.

Desmopan® is a registered trademark of Bayer Aktiengesellschaft, Farbenfabriken. Hypro® is a registered trademark of Pentair.

## Order Information

Model Number	Max GPM	Max LPM	Max PSI	Max BAR	Max RPM	Drive and Control Unit
9910-D403	9.9	37.5	580	40	550	1" HB inlet, 1/2" HB outlet
9910-D403GRGI	9.9	37.5	580	40	3600	Assembled with gearbox 9910-KIT1640 and control 9910-GR40 for mounting on 5-6 hp gas engines



# Medium Pressure, 2 Diaphragm

## Model 9910-D50, D50AP-A and D50-B



- Max. fluid temperature: 140°F/60°C
- Shaft: flanged for shaft kit (D50); flange w/1" shaft ext. (D50AP-A)
- Diaphragms: 2, full-hydraulic, Desmopan® standard, Buna available (D50-B has Buna diaphragms)
- Housing components for liquid handling: epoxy coated
- Pump shaft rotation: CW and CCW
- For shaft kits and other drive options, see pages 86-87.
- Recommended control unit: 9910-GS40GI, see page 87.
- Weight: 35 lbs./15.9 kg

Pressure in PSI and BAR	GPM		HP		GPM		HP		GPM		HP	
	LPM	HP	LPM	HP	LPM	HP	LPM	HP	LPM	HP	LPM	HP
	@350 RPM		@400 RPM		@450 RPM		@500 RPM		@550 RPM			
<b>0 PSI</b>	9.7	0.36	11.9	0.49	12.3	0.64	13.2	0.77	14.8	0.94		
<b>0 BAR</b>	36.8	0.36	45.0	0.49	46.6	0.64	49.9	0.77	55.8	0.94		
<b>145 PSI</b>	9.3	1.08	11.5	1.25	11.9	1.49	12.9	1.59	14.6	1.76		
<b>10 BAR</b>	35.1	1.08	43.3	1.25	44.9	1.49	48.6	1.59	55.1	1.76		
<b>290 PSI</b>	9.1	1.85	11.0	2.09	11.7	2.40	12.6	2.72	14.5	2.97		
<b>20 BAR</b>	34.4	1.85	41.5	2.09	44.1	2.40	47.4	2.72	54.9	2.97		
<b>465 PSI</b>	8.8	2.61	10.8	3.00	11.6	3.41	12.0	3.80	14.4	4.03		
<b>30 BAR</b>	33.2	2.61	40.6	3.00	43.6	3.41	45.3	3.80	54.4	4.03		
<b>580 PSI</b>	8.6	3.44	10.3	3.77	11.4	4.38	11.9	4.92	14.1	5.17		
<b>40 BAR</b>	32.5	3.44	38.9	3.77	42.9	4.38	44.7	4.92	53.3	5.17		

All HP requirements listed in the table are electrical. For approximate gasoline equivalent, multiply by 1.3.

### Order Information

Model Number	Max GPM	Max LPM	Max PSI	Max BAR	Max RPM	Port Size
9910-D50	14.8	56.0	580	40	550	1-1/4" HB inlet, 1/2" HB outlet
9910-D50-B	Same pump as 9910-D50 w/Buna-N diaphragms					
9910-D50AP-A	Same pump as 9910-D50 w/solid 1" thru shaft					

# Medium Pressure, 3 Diaphragm

## Model 9910-D503, D503GRGI and D503GRGI34



- Max. fluid temperature: 140°F/60°C
- Shaft: flanged adapter (D503); 1" hollow shaft for gas engine mount (D503GRGI)
- Diaphragms: 3, semi-hydraulic, Desmopan® standard, Buna available
- Housing: anodized aluminum
- Mounting base: included
- Pump shaft rotation: CW and CCW
- For shaft kits and other drive options, see pages 86-87.
- Recommended control unit: 9910-RM40, see page 88.
- Weight: 28 lbs./12.7 kg

Pressure in PSI and BAR	GPM		HP		GPM		HP		GPM		HP	
	LPM	HP	LPM	HP	LPM	HP	LPM	HP	LPM	HP	LPM	HP
	@350 RPM		@400 RPM		@450 RPM		@500 RPM		@550 RPM			
<b>0 PSI</b>	9.4	0.52	12.1	0.86	12.6	0.91	13.4	1.09	14.3	1.32		
<b>0 BAR</b>	35.4	0.52	45.5	0.86	47.6	0.91	50.5	1.09	54.1	1.32		
<b>145 PSI</b>	9.0	1.24	11.6	1.68	11.9	1.72	13.2	1.85	14.1	2.09		
<b>10 BAR</b>	34.1	1.24	44.0	1.68	44.9	1.72	49.7	1.85	53.3	2.09		
<b>290 PSI</b>	8.9	2.05	11.4	2.67	11.7	2.74	12.8	3.01	13.8	3.30		
<b>20 BAR</b>	33.6	2.05	43.2	2.67	44.1	2.74	48.4	3.01	51.9	3.30		
<b>465 PSI</b>	8.7	2.78	11.3	3.72	11.6	3.90	12.6	4.14	13.6	4.41		
<b>30 BAR</b>	33.0	2.78	42.5	3.72	43.6	3.90	47.4	4.14	51.4	4.41		
<b>580 PSI</b>	8.5	3.56	11.0	4.67	11.4	4.83	12.2	5.37	13.4	5.49		
<b>40 BAR</b>	32.2	3.56	41.7	4.67	42.9	4.83	46.0	5.37	50.5	5.49		

All HP requirements listed in the table are electrical. For approximate gasoline equivalent, multiply by 1.3. Desmopan® is a registered trademark of Bayer Aktiengesellschaft, Farbenfabriken. Hypro® is a registered trademark of Pentair.

### Order Information

Model Number	Max GPM	Max LPM	Max PSI	Max BAR	Max RPM	Drive and Control Unit
9910-D503	14.3	54.1	580	40	550	-
9910-D503GRGI	14.3	54.1	580	40	3600	Assembled with gearbox 9910-KIT1642 and control 9910-RM40 for mounting on 8 hp gas engine
9910-D503GRGI34	14.3	54.1	290	20	3600	Assembled with gearbox 9910-KIT1640 and control 9910-RM40 for mounting on 5-6.5 hp gas engines

# High Pressure, 3 Diaphragm

## Model 9910-D813 and D813GRGI



- Max. fluid temperature: 140°F/60°C
- Shaft: Flanged adapter and 1-3/8" - 6 splined male shaft ext. (D813); 1" hollow shaft for gas engine mount (D813GRGI)
- Diaphragms: 3, semi-hydraulic, Desmopan® standard Buna available
- Housing: anodized aluminum
- Mounting base: included
- Pump shaft rotation: CW and CCW
- For shaft kits and other drive options, see pages 86-87.
- Recommended control unit: 9910-VDR50 or 9910-GS50GI, see page 88.
- Weight: 50 lbs./22.7 kg (D813); 66 lbs./30 kg (D813GRGI)

Pressure in PSI and BAR	GPM		HP		GPM		HP		GPM		HP	
	LPM	HP	LPM	HP	LPM	HP	LPM	HP	LPM	HP	LPM	HP
	@350 RPM		@400 RPM		@450 RPM		@500 RPM		@550 RPM			
0 PSI	14.7	0.41	17.0	0.64	18.2	0.74	19.8	0.93	20.8	1.12		
0 BAR	55.6	0.41	64.3	0.64	68.7	0.74	74.7	0.93	78.6	1.12		
217 PSI	13.9	2.23	16.1	2.51	17.8	2.93	19.5	3.40	19.9	3.61		
15 BAR	52.3	2.23	60.8	2.51	67.1	2.93	73.7	3.40	75.0	3.61		
435 PSI	13.6	4.06	15.6	4.65	17.4	5.26	19.1	5.80	19.7	6.23		
30 BAR	51.2	4.06	58.7	4.65	65.5	5.26	71.9	5.80	74.3	6.23		
580 PSI	13.5	5.22	15.3	6.03	17.2	6.81	18.4	7.51	19.2	8.01		
40 BAR	50.8	5.22	57.7	6.03	64.8	6.81	69.4	7.51	72.6	8.01		
725 PSI	13.4	6.30	15.0	7.31	16.9	8.33	17.9	9.23	19.0	9.82		
50 BAR	50.4	6.30	56.5	7.31	63.9	8.33	67.5	9.23	71.8	9.82		

All HP requirements listed in the table are electrical.  
For approximate gasoline equivalent, multiply by 1.3.

### Order Information

Model Number	Max GPM	Max LPM	Max PSI	Max BAR	Max RPM	Port Size	Shaft Output
9910-D813	20.8	78.7	725	50	550	1-1/4" HB inlet, 3/4" NPT outlet	1-3/8" - 6 splined male shaft extension
9910-D813GRGI	20.8	78.7	725	50	3600	Assembled with gearbox 9910-KIT1642 and control 9910-VDR50 for mounting on 13 hp gas engine	

# High Pressure, 4 Diaphragm

## Model 9910-D1064 and D1064GRGI



- Max. fluid temperature: 140°F/60°C
- Shaft: Flanged adapter and 1-3/8" - 6 splined male shaft ext. (D1064); 1" hollow shaft for gas engine mount (D1064GRGI)
- Diaphragms: 4, semi-hydraulic, Desmopan® standard, Buna available
- Housing: anodized aluminum
- Mounting base: included
- Pump shaft rotation: CW and CCW
- For shaft kits and other drive options, see pages 86-87.
- Recommended control unit: 9910-VDR50 or 9910-GS50GI, see page 88.
- Weight: 54 lbs./24.5 kg (D1064); 76 lbs./34.5 kg (D1064GRGI)

Pressure in PSI and BAR	GPM		HP		GPM		HP		GPM		HP	
	LPM	HP	LPM	HP	LPM	HP	LPM	HP	LPM	HP	LPM	HP
	@350 RPM		@400 RPM		@450 RPM		@500 RPM		@550 RPM			
0 PSI	19.6	0.75	22.4	1.04	25.2	1.33	27.1	1.59	28.7	1.90		
0 BAR	74.0	0.75	84.6	1.04	95.1	1.33	102.4	1.59	108.5	1.90		
217 PSI	18.8	2.95	21.6	3.41	24.5	3.92	26.8	4.33	28.5	4.71		
15 BAR	70.8	2.95	81.6	3.41	92.3	3.92	101.1	4.33	107.6	4.71		
435 PSI	18.4	5.40	21.1	6.20	23.9	7.01	26.2	7.77	28.3	8.28		
30 BAR	69.4	5.40	79.5	6.20	90.3	7.01	98.8	7.77	106.7	8.28		
580 PSI	18.2	7.01	21.0	8.05	23.7	9.12	26.0	10.06	28.0	10.79		
40 BAR	68.8	7.01	79.2	8.05	89.3	9.12	98.1	10.06	105.8	10.79		
725 PSI	18.0	8.65	20.8	9.88	23.3	11.18	25.9	12.38	27.8	13.13		
50 BAR	67.9	8.65	78.4	9.88	87.9	11.18	97.6	12.38	104.7	13.13		

All HP requirements listed in the table are electrical.  
For approximate gasoline equivalent, multiply by 1.3.

Desmopan® is a registered trademark of Bayer Aktiengesellschaft, Farbenfabriken. Hypro® is a registered trademark of Pentair.

### Order Information

Model Number	Max GPM	Max LPM	Max PSI	Max BAR	Max RPM	Port Size	Shaft Output
9910-D1064	28.7	108.6	725	50	550	1-1/4" HB inlet, 3/4" NPT outlet	1-3/8" - 6 splined male shaft extension
9910-D1064GRGI	28.7	108.6	725	50	3600	Assembled with gearbox 9910-KIT1642 and control 9910-VDR50 for mounting on 18 hp gas engine	

# High Pressure, 5 Diaphragm

## Model 9910-D1265



- Max. fluid temperature: 140°F/60°C
- Shaft: flanged adapter and 1-3/8" - 6 splined male shaft ext.
- Diaphragms: 5, semi-hydraulic, Desmopan® standard, Buna available
- Housing: anodized aluminum
- Mounting base: included
- Pump shaft rotation: CW and CCW
- For shaft kits and other drive options, see pages 86-87.
- Recommended control unit: 9910-VDR50 or 9910-GS50GI, see page 88.
- Weight: 67 lbs./30.4 kg

Pressure in PSI and BAR	GPM		HP		GPM		HP		GPM		HP	
	LPM	HP	LPM	HP	LPM	HP	LPM	HP	LPM	HP	LPM	HP
	@350 RPM		@400 RPM		@450 RPM		@500 RPM		@550 RPM			
0 PSI	23.9	1.23	26.9	1.62	29.8	2.10	32.0	2.62	33.4	2.95		
0 BAR	90.0	1.23	101.6	1.62	112.6	2.10	120.8	2.62	126.1	2.95		
217 PSI	22.8	3.80	26.1	4.44	29.2	5.14	31.7	5.50	33.1	5.81		
15 BAR	86.0	3.80	98.3	4.44	110.3	5.14	119.6	5.50	124.9	5.81		
435 PSI	22.5	6.91	25.6	7.93	28.8	9.06	31.5	9.64	32.8	10.03		
30 BAR	84.8	6.91	96.7	7.93	108.5	9.06	118.9	9.64	123.9	10.03		
580 PSI	22.3	9.03	25.4	10.30	28.5	11.61	31.2	12.33	32.7	12.60		
40 BAR	84.3	9.03	95.7	10.30	107.5	11.61	117.7	12.33	123.4	12.60		
725 PSI	22.2	11.12	25.1	12.61	28.3	14.44	30.9	15.31	31.5	15.41		
50 BAR	83.7	11.12	94.8	12.61	106.8	14.44	116.4	15.31	118.7	15.41		

All HP requirements listed in the table are electrical. For approximate gasoline equivalent, multiply by 1.3.

### Order Information

Model Number	Max GPM	Max LPM	Max PSI	Max BAR	Max RPM	Port Size	Shaft Output
9910-D1265	33.4	126.4	725	50	550	1-1/2" HB inlet, 3/4" NPT outlet	1-3/8" - 6 splined male shaft extension

# High Pressure, 3 Diaphragm

## Model 9910-DBS110 and DBA110



- Max fluid temp: 140°F/60°C
- Diaphragms: 3, semi-hydraulic, Buna standard
- Housing components for liquid handling:
  - DBS - external bronze manifolds and brass heads
  - DBA - external manifolds and heads in anodized aluminum
- Pump shaft rotation: CW and CCW
- Recommended control unit: 9910-BMH50 or 9910-GH50, see page 88.
- Weight: 114 lbs./51.7 kg (DBS110); 88 lbs./40 kg (DBA110)

Pressure in PSI and BAR	GPM		HP		GPM		HP		GPM		HP	
	LPM	HP	LPM	HP	LPM	HP	LPM	HP	LPM	HP	LPM	HP
	@350 RPM		@400 RPM		@450 RPM		@500 RPM		@550 RPM			
0 PSI	19.2	0.53	21.9	0.60	24.6	0.78	27.3	0.89	30.0	1.12		
0 BAR	72.6	0.53	82.8	0.60	93.0	0.78	103.2	0.89	113.1	1.12		
217 PSI	18.7	2.91	21.5	3.18	24.2	3.74	27.1	4.02	29.3	4.50		
15 BAR	70.7	2.91	81.2	3.18	91.4	3.74	102.1	4.02	110.6	4.50		
435 PSI	18.5	5.19	21.2	5.91	24.0	6.51	26.9	7.51	29.0	8.29		
30 BAR	69.9	5.19	79.9	5.91	90.7	6.51	101.4	7.51	109.4	8.29		
580 PSI	18.4	6.87	20.9	7.66	23.7	8.69	26.4	9.67	28.7	10.71		
40 BAR	69.5	6.87	78.9	7.66	89.3	8.69	99.8	9.67	108.2	10.71		
725 PSI	18.2	8.43	20.8	9.60	23.5	10.73	25.9	11.90	28.6	13.11		
50 BAR	68.7	8.43	78.5	9.60	88.5	10.73	97.7	11.90	108.0	13.11		

### Order Information

Model Number	Max GPM	Max LPM	Max PSI	Max BAR	Max RPM	Port Size	Shaft Output
9910-DBS110	30.0	113.6	725	50	550	1-1/2" HB inlet, 3/4" NPT outlet	1-3/8" - 6 splined male double-ended shaft
9910-DBA110	30.0	113.6	725	50	550	1-1/2" HB inlet, 3/4" NPT outlet	1-3/8" - 6 splined male double-ended shaft

All HP requirements listed in the table are electrical. For approximate gasoline equivalent, multiply by 1.3.  
Desmopan® is a registered trademark of Bayer Aktiengesellschaft, Farbenfabriken. Hypro® is a registered trademark of Pentair.

# High Pressure, 3 Diaphragm

## Model 9910-DBS140 and DBA140



- Max fluid temp: 140°F/60°C
- Diaphragms: 3, semi-hydraulic, Buna standard
- Housing components for liquid handling:
  - DBS – external bronze manifolds and brass heads
  - DBA – external manifolds and heads in anodized aluminum
- Weight: 114 lbs./51.7 kg (DBS140); 88 lbs./40 kg (DBA140)
- Pump shaft rotation: CW and CCW
- Recommended control unit: 9910-BMH50 or 9910-GH50, see page 88.
- Weight: 114 lbs./51.7 kg (DBS140); 88 lbs./40 kg (DBA140)

### Order Information

Pressure in PSI and BAR	GPM		HP		GPM		HP		GPM		HP	
	LPM	HP	LPM	HP	LPM	HP	LPM	HP	LPM	HP	LPM	HP
	@350 RPM		@400 RPM		@450 RPM		@500 RPM		@550 RPM			
<b>0 PSI</b>	25.1	0.82	28.5	1.11	31.5	1.50	34.8	2.02	37.8	2.58		
<b>0 BAR</b>	94.6	0.82	107.5	1.11	119.0	1.50	131.5	2.02	142.6	2.58		
<b>217 PSI</b>	24.1	3.47	27.5	4.01	30.7	4.51	33.2	5.01	37.3	5.61		
<b>15 BAR</b>	91.1	3.47	103.8	4.01	115.9	4.51	125.3	5.01	140.9	5.61		
<b>435 PSI</b>	23.8	6.53	27.2	7.69	30.2	8.39	32.6	9.28	36.7	10.34		
<b>30 BAR</b>	89.9	6.53	102.8	7.69	114.1	8.39	123.1	9.28	138.7	10.34		
<b>580 PSI</b>	23.6	8.53	26.8	9.73	29.8	10.82	32.2	12.02	36.5	13.33		
<b>40 BAR</b>	89.1	8.53	101.0	9.73	112.6	10.82	121.5	12.02	137.6	13.33		
<b>725 PSI</b>	23.3	10.47	26.5	11.88	29.7	13.28	31.9	14.67	36.3	16.28		
<b>50 BAR</b>	88.1	10.47	100.0	11.88	112.2	13.28	120.4	14.67	137.0	16.28		

All HP requirements listed in the table are electrical.  
For approximate gasoline equivalent, multiply by 1.3.

Model Number	Max GPM	Max LPM	Max PSI	Max BAR	Max RPM	Port Size	Shaft Output
9910-DBS140	37.8	143.1	725	50	550	1-1/2" HB inlet, 3/4" NPT outlet	1-3/8" - 6 splined male double- ended shaft
9910-DBA140	37.8	143.1	725	50	550	1-1/2" HB inlet, 3/4" NPT outlet	1-3/8" - 6 splined male double- ended shaft

# High Pressure, 4 Diaphragm

## Model 9910-DBS160 and DBA160



- Max fluid temp: 140°F/60°C
- Diaphragms: 4, semi-hydraulic, Buna standard
- Housing components for liquid handling:
  - DBS – external bronze manifolds and brass heads
  - DBA – external manifolds and heads in anodized aluminum
- Pump shaft rotation: CW and CCW
- Recommended control unit: 9910-BMH50 or 9910-GH50, see page 88.
- Weight: 143 lbs./64.9 kg (DBS160); 112 lbs./50.9 kg (DBA160)

### Order Information

Pressure in PSI and BAR	GPM		HP		GPM		HP		GPM		HP	
	LPM	HP	LPM	HP	LPM	HP	LPM	HP	LPM	HP	LPM	HP
	@350 RPM		@400 RPM		@450 RPM		@500 RPM		@550 RPM			
<b>0 PSI</b>	25.5	1.12	29.3	1.52	32.6	1.83	36.1	2.23	39.6	2.62		
<b>0 BAR</b>	96.3	1.12	110.4	1.52	122.9	1.83	136.3	2.23	149.4	2.62		
<b>217 PSI</b>	24.9	3.72	28.7	4.39	32.1	4.83	35.7	5.27	39.1	5.91		
<b>15 BAR</b>	94.1	3.72	108.4	4.39	121.3	4.83	134.8	5.27	147.5	5.91		
<b>435 PSI</b>	24.6	6.90	28.3	8.01	31.9	8.89	35.3	9.80	38.5	10.75		
<b>30 BAR</b>	93.0	6.90	106.6	8.01	120.5	8.89	133.4	9.80	145.3	10.75		
<b>580 PSI</b>	24.5	8.88	28.1	10.22	31.5	11.49	35.0	12.77	38.4	14.12		
<b>40 BAR</b>	92.4	8.88	106.1	10.22	118.9	11.49	132.2	12.77	144.9	14.12		
<b>725 PSI</b>	24.2	10.91	27.9	12.46	31.3	14.01	34.8	15.64	38.2	17.28		
<b>50 BAR</b>	91.4	10.91	105.3	12.46	118.2	14.01	131.5	15.64	144.2	17.28		

All HP requirements listed in the table are electrical. For approximate gasoline equivalent, multiply by 1.3.

Model Number	Max GPM	Max LPM	Max PSI	Max BAR	Max RPM	Port Size	Shaft Output
9910-DBS160	39.6	149.9	725	50	550	1-1/2" HB inlet, 3/4" NPT outlet	1-3/8" - 6 splined male double- ended shaft
9910-DBA160	39.6	149.9	725	50	550	1-1/2" HB inlet, 3/4" NPT outlet	1-3/8" - 6 splined male double- ended shaft

# High Pressure, 4 Diaphragm

Model 9910-DBS200 and DBA200



- Max fluid temp: 140°F/60°C
- Diaphragms: 4, semi-hydraulic, Buna standard
- Housing components for liquid handling:
  - DBS – external bronze manifolds and brass heads
  - DBA – external manifolds and heads in anodized aluminum
- Pump shaft rotation: CW and CCW
- Recommended control unit: 9910-GH50, see page 88.
- Weight: 143 lbs./64.9 kg (DBS200); 112 lbs./50.9 kg (DBA200)

Pressure in PSI and BAR	GPM		HP		GPM		HP		GPM		HP	
	LPM	HP	LPM	HP	LPM	HP	LPM	HP	LPM	HP	LPM	HP
	@350 RPM		@400 RPM		@450 RPM		@500 RPM		@550 RPM			
0 PSI	33.0	1.44	37.3	1.92	41.6	2.74	45.9	3.03	49.7	3.67		
0 BAR	124.5	1.44	140.7	1.92	156.9	2.74	173.1	3.03	187.6	3.67		
217 PSI	32.0	4.68	36.7	5.38	41.0	6.13	45.3	6.91	49.1	7.64		
15 BAR	120.8	4.68	138.5	5.38	154.8	6.13	170.8	6.91	185.4	7.64		
435 PSI	31.4	8.79	36.1	10.24	40.4	11.44	44.8	12.71	48.7	13.92		
30 BAR	118.4	8.79	136.2	10.24	152.6	11.44	169.0	12.71	183.9	13.92		
580 PSI	31.3	11.35	35.8	13.01	40.0	14.69	44.6	16.45	48.3	17.98		
40 BAR	118.2	11.35	135.0	13.01	151.1	14.69	168.3	16.45	182.5	17.98		
725 PSI	31.1	14.01	35.3	15.96	39.9	18.12	44.4	20.21	48.2	22.21		
50 BAR	117.2	14.01	133.1	15.96	150.5	18.12	167.5	20.21	182.1	22.21		

All HP requirements listed in the table are electrical.  
For approximate gasoline equivalent, multiply by 1.3.

## Order Information

Model Number	Max GPM	Max LPM	Max PSI	Max BAR	Max RPM	Port Size	Shaft Output
9910-DBS200	49.7	188.1	725	50	550	1-1/2" HB inlet, 3/4" NPT outlet	1-3/8" - 6 splined male double-ended shaft
9910-DBA200	49.7	188.1	725	50	550	1-1/2" HB inlet, 3/4" NPT outlet	1-3/8" - 6 splined male double-ended shaft

# Gas Engine-Driven, Medium Pressure, 2 Diaphragm

Models: D252GRGI-25, D252GRGI-55, 1534



- Closed-coupled, gas engine driven (EPA & CARB certified)
- Max. fluid temperature: 140°F/60°C
- Diaphragms: 2, semi-hydraulic, Desmopan® standard, Buna available
- Housing: anodized aluminum
- Mounting base: included

## Order Information

Pressure in PSI and BAR	GPM
	LPM
0 PSI	5.9
0 BAR	22.3
50 PSI	5.3
3.4 BAR	20.0
100 PSI	5.2
6.9 BAR	19.5
150 PSI	5.1
10.3 BAR	19.3
200 PSI	5.0
13.6 BAR	18.9
250 PSI	4.9
17.0 BAR	18.5
290 PSI	4.9
20 BAR	18.5

Model Number	Max GPM	Max LPM	Max PSI	Max BAR	Max RPM	Control Unit and Gearbox	Engine Mfr. and hp
D252GRGI-25	5.9	22.3	290	20	3600	9910-KIT1990	PowerPro 2.5 hp
D252GRGI-55	5.9	22.3	290	20	2800	9910-KIT1990	PowerPro 6.5 hp
1534	5.9	22.3	290	20	2800	9910-KIT1990	Briggs and Stratton® 3.5 hp

Desmopan® is a registered trademark of Bayer Aktiengesellschaft, Farbenfabriken. Hypro® is a registered trademark of Pentair.

# Gas Engine-Driven, Medium Pressure, 2 Diaphragm

Model: D30HRGI-65, D30HRGI-65E, D30GRGI-65, 1535, D30HRGI



- Closed-coupled, gas engine driven (EPA & CARB certified)
- Max. fluid temperature: 140°F/60°C
- Diaphragms: 2, semi-hydraulic, Desmopan® standard, Buna available
- Housing components for liquid handling: epoxy-coated

## Order Information

Pressure in PSI and BAR	D30HRGI-65,65E	D30GRGI-65,1535
	GPM	GPM
	LPM	LPM
	Ø550 RPM	Ø550 RPM
0 PSI	9.6	9.3
0 BAR	36	35
290 PSI	8.8	9.3
20 BAR	33	34
435 PSI	8.6	8.7
30 BAR	33	33
580 PSI	8.3	8.2
40 BAR	31	31

Model Number	Max GPM	Max LPM	Max PSI	Max BAR	Max RPM	Control Unit and Gearbox	Engine Mfr. and hp
D30HRGI-65	9.6	36.3	580	40	3600	GS40GI and 8000-0056	PowerPro 6.5 HP
D30HRGI-65E	9.6	36.3	580	40	3600	GS40GI and 8000-0056	PowerPro 6.5 HP w/ electric start
D30GRGI-65	9.6	36.3	580	40	3600	GS40GI and KIT1640 (gearbox)	PowerPro 6.5 hp
1535	9.3	35.2	580	40	3600	GS40GI and KIT1640 (gearbox)	Industrial Plus Briggs & Stratton® 6.5 hp
D30HRGI	9.3	35.2	580	40	3600	GS40GI and KIT1640 (gearbox)	Less engine

# Gas Engine-Driven, Medium Pressure, 3 Diaphragm

Model: D403HRGI-65, D403HRGI-65E, D403GRGI-65, D403HRGI



- Closed-coupled, gas engine driven (EPA & CARB certified)
- Max. fluid temperature: 140°F/60°C
- Diaphragms: 3, semi-hydraulic, Desmopan® standard, Buna available
- Housing: anodized aluminum
- Mounting base: included

## Order Information

Pressure in PSI and BAR	D403HRGI-65,65E	D403GRGI-65
	GPM	GPM
	LPM	LPM
	Ø550 RPM	Ø550 RPM
0 PSI	9.9	10.6
0 BAR	38	40
290 PSI	9.7	9.8
20 BAR	37	37
435 PSI	9.6	9.7
30 BAR	36	37
580 PSI	9.5	9.5
40 BAR	36	36

Model Number	Max GPM	Max LPM	Max PSI	Max BAR	Max RPM	Control Unit and Gearbox	Engine Mfr. and hp
D403HRGI-65	9.9	37.5	580	40	3600	GR40 and 8000-0056	PowerPro 6.5 HP
D403HRGI-65E	9.9	37.5	580	40	3600	GR40 and 8000-0056	PowerPro 6.5 HP w/ electric start
D403HRGI	9.9	37.5	580	40	3600	GR40 and 8000-0056	Less engine
D403GRGI-65	10.6	40.1	580	40	3600	GR40 and KIT1640 (gearbox)	PowerPro 6.5 hp

Desmopan® is a registered trademark of Bayer Aktiengesellschaft, Farbenfabriken. Hypro® is a registered trademark of Pentair.

# Gas Engine-Driven, Heavy-Duty Medium Pressure, 3 Diaphragm

Model: D503HRGI-65, D503HRGI



- Hypro quality diaphragm pumps powered by field-proven PowerPro certified engines (EPA & CARB certified)
- Oil-bath design and premium quality synthetic diaphragms provides longer life and greater reliability
- Oil-bath design also allows pump to be run dry
- Self-priming operation
- Corrosive, abrasive and general use chemical compatibility
- Visual oil-level sight glass
- Supported with a one-year Hypro warranty on both pump and PowerPro engine
- Diaphragms: 3, semi-hydraulic, Desmopan® standard, Buna available

Pressure in PSI and BAR	D503HRGI-65,65E
	GPM
	LPM
	@550 RPM
<b>0 PSI</b>	14.3
<b>0 BAR</b>	54
<b>145 PSI</b>	14.1
<b>10 BAR</b>	53
<b>290 PSI</b>	13.8
<b>20 BAR</b>	52

## Order Information

Model Number	Max GPM	Max GPM	Max PSI	Max BAR	Max RPM	Control Unit & Gearbox	Engine Mfg. & HP
D503HRGI-65	14.3	54.1	290	20	3600	RM40 and 8000-0056	PowerPro 6.5 HP
D503HRGI-65E	14.3	54.1	290	20	3600	RM40 and 8000-0056	PowerPro 6.5 HP w/ electric start
D503HRGI	14.3	54.1	290	20	3600	RM40 and 8000-0056	Less engine

# Diaphragm Kits and Applications



## Hypro Pump Oil

Part Number	Description	Weight	
		US Units	Metric
2160-0038	1 quart of specially-formulated pump oil	2 lbs.	907 g
2160-0047	1 gallon of specially-formulated pump oil	9 lbs.	4.1 kg
2160-0048	2 1/2 gallons of specially-formulated pump oil	22 lbs.	9.98 kg

All Hypro Plunger Pumps are shipped with oil. To optimize pump life, Hypro recommends an oil change after 40 hours of break-in operation and every three months or 500 hour intervals thereafter. Use only Hypro oil.



## 1-3/8"-6 Spline Female PTO Shaft Kits

Kit Number	Description	Weight	
		US Units	Metric
9910-KIT1704	For Model 9910-D50, D30, D303 and D403 pumps	7 lbs.	3.2 kg
9910-KIT1708	For Model 9910-D70 and D115 pumps	5.25 lbs.	2.4 kg
9910-KIT2204	For Model 9910-D503, D813, D1064 and D1265 pumps	7 lbs.	3.2 kg

Kit includes a female PTO coupler and retaining clamp, torque arm and mounting bracket, chains and necessary hardware.



## 1-3/8"-6 Spline Male PTO Shaft Kits

Kit Number	Description	Weight	
		US Units	Metric
9910-KIT1702	For Model 9910-D30 pump	3 lbs.	1.4 kg
9910-KIT1706	For Model 9910-D50 pump	4.25 lbs.	1.9 kg
*9910-KIT1710	For Model 9910-D70 and D115 pumps	5.5 lbs.	2.5 kg
9910-KIT2200	For Model 9910-D503, D303 and D403 pumps	4.25 lbs.	1.9 kg
9910-KIT2201	For Model 9910-D813, D1064 and D1265 pumps	4.25 lbs.	1.9 kg

\*Kit includes a male PTO shaft adapter, mounting bracket and necessary hardware.



## 1" Solid Shaft Kits

Kit Number	Description	Weight	
		US Units	Metric
9910-KIT1703	For Model 9910-D30 pump	2.5 lbs.	1.7 kg
9910-KIT1707	For Model 9910-D50 pump	3.75 lbs.	1.7 kg
*9910-KIT1711	For Model 9910-D70 and D115 pumps	5 lbs.	2.3 kg
9910-KIT2202	For Model 9910-D503, D303 and D403 pumps	3.75 lbs.	1.7 kg
9910-KIT2203	For Model 9910-D813, D1064 and D1265 pumps	3.75 lbs.	1.7 kg

\*Kit includes a male PTO shaft adapter, mounting bracket and necessary hardware.

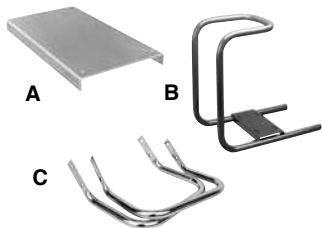

## Base Plates and Carrying Handles

Part Number	Description	Ref.	Est. Weight Ea.	
			US Units	Metric
1510-0005	8" x 15" with 12 gauge	A	6 lbs.	2.7 kg
1510-0002	9 1/2" x 18" with 10 gauge	A	8 lbs.	3.6 kg
1510-0001	12" x 21" with 7 gauge	A	16 lbs.	7.3 kg
1510-0016	14" x 26" with 7 gauge	A	21 lbs.	9.5 kg
1510-0075	9-1/2" x 4-1/2" with 14 gauge (for 3 and 5 hp Briggs® or Honda® and 5/6 frame electric)	B	11 lbs.	5 kg
2801-0001	Two handles, mounting bolts and nuts for #1510-0016 base	C	3 lbs. 4 oz.	1.5 kg
2801-0002	Two handles, mounting bolts and nuts for #1510-0001 base	C	3 lbs. 3 oz.	1.4 kg

## Diaphragm Pump Repair Kits



For Pump Model	Diaphragm Kit (Desmopan®)	Diaphragm Kit (Buna-N)	Valve Kit	O-ring Kit
9910-D70	9910-KIT1720	-----	9910-KIT2364	9910-KIT2365
9910-D115 and D135	9910-KIT1721	-----	9910-KIT2370	9910-KIT2026
9910-D160	9910-KIT1730	-----	9910-KIT2374	9910-KIT1908
9910-D250	9910-KIT1722	-----	9910-KIT2114	9910-KIT1904
9910-D12GRGI	9910-KIT1882	-----	9910-KIT1992	
9910-D503	9910-KIT1881	-----	9910-KIT1987	9910-KIT1984
9910-D252 (all versions)	9910-KIT1723	-----	9910-KIT2408	9910-KIT2409
9910-D30 (all versions)	9910-KIT1724	9910-KIT2110	9910-KIT1917	9910-KIT1916
9910-D50	9910-KIT1725	9910-KIT2111	9910-KIT1920	9910-KIT1919
9910-DBS110, DBS140, DBA110 and DBA140	-----	9910-KIT2444	9910-KIT2445	9910-KIT2446
9910-DBS160, DBS200, DBA160 and DBA200	-----	9910-KIT2456	9910-KIT2374	9910-KIT2457
9910-D303	9910-KIT2423	-----	9910-KIT2388	9910-KIT2389
9910-D403	9910-KIT2423	-----	9910-KIT2388	9910-KIT2389
9910-D813	9910-KIT2479	-----	9910-KIT1963	9910-KIT2376
9910-D1064	9910-KIT2480	-----	9910-KIT1964	9910-KIT2378
9910-D1265	9910-KIT2100	-----	9910-KIT2024	9910-KIT2347
9910-D1554	9910-KIT1734	-----	9910-KIT1965	9910-KIT1972
9910-D1516	9910-KIT2113	-----	9910-KIT2053	9910-KIT2349

Honda® is a registered trademark of Honda Motor Co., Ltd.  
 Briggs & Stratton® is a registered trademark of Briggs & Stratton Corporation.  
 Hypro® is a registered trademark of Pentair Ltd.



# Pump and Gear Reduction Kits



## Model 9910-KIT1640

- For Pump Models 9910-D30, D303 and D403
- 6:1 gear box
- For standard 5.5 hp gas engine with 3/4" shaft
- Can be used with 9910-D50, D503 and D813, providing that pumps are operated at lower pressures that do not exceed 5 hp gas engine compatibility.
- Weight: 6.5 lbs./2.9 kg



## Model 9910-KIT1642

- For Pump Models 9910-D50, D503, D813, D1064 and D1265
- 6:1 gear box
- For standard 8-18 hp gas engine with 1" shaft
- Weight: 8.5 lbs./3.9 kg



## Model 8000-0056

- For Pump Models 9910-D30, D403, D50, and D503
- New and improved bolt-through pinion gear to help prevent keyway fretting and seizing
- Engine mounting flange designed for ease of assembly with standard tools
- Robust 6:1 gear design for increases longevity
- Increased oil capacity
- Made for use on gas engines with 3/4" shaft
- Available pre-assembled on HRGI models

# Hydraulic Flange Kits



## Model 9910-HYD5312

- Fits Diaphragm Pump Models 9910-D30, D50, D303, D403, D503, D813, D1064 and D1265
- Includes: one flange with SAE "A" 2 bolt, one 1" hollow shaft and two bolts



## Model 9910-HYD1570

- Fits Diaphragm Pump Models 9910-D160 and D250
- Includes: one flange with SAE "A" 2 bolt, one 1" coupling and hardware for mounting



## Model 9910-HYD2495

- Fits Diaphragm Pump Models 9910-D70, D115
- Includes: one flange with SAE "A" 2 bolt, one 1" coupling, two pins, spacer and hardware for mounting



## Model 9910-KIT55357

- Fits Diaphragm Pump Models 9910-DP423, DP573 & DP763
- Includes: one flange with SAE "A" 2 bolt, one 1" coupling and hardware for mounting

# Diaphragm Control Units

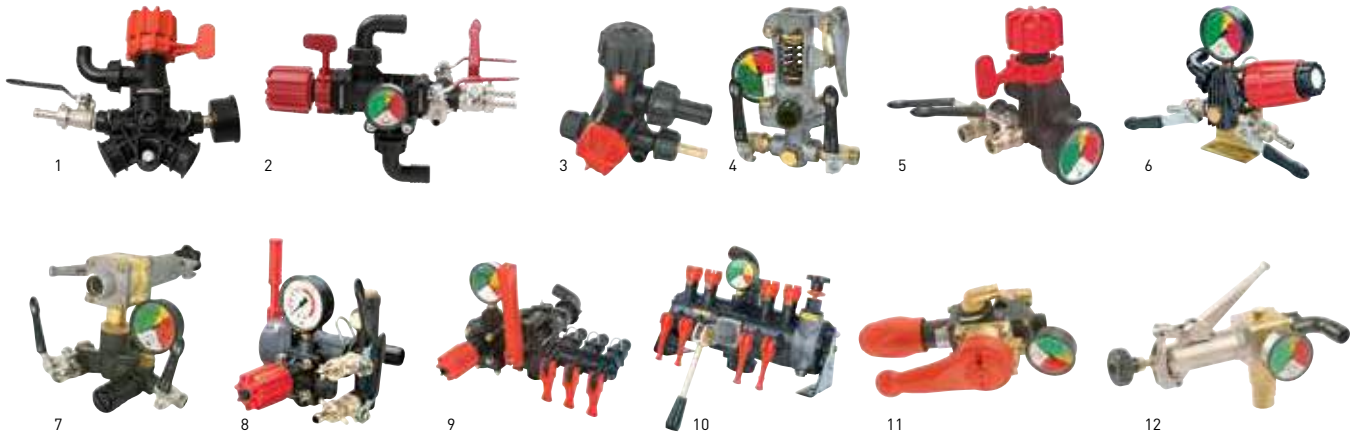

Ref #	Model	For Pump Model	Includes	Max Flow	Max Pressure	Weight
1	9910-GS25	9910-DP423	Pressure gauge, adjustable high pressure relief valve, 1/2" HB outlet with ball valve shutoff, bypass lever, 3/4" HB bypass, 1" HB inlet	11 gpm (42 lpm)	290 psi (20 bar)	2 lbs. (0.9 kg)
2	9910-GS35S	9910-DP573 & 9910-DP763	Pressure gauge, adjustable high pressure relief valve, two 1/2" HB outlet with ball valve shutoff, bypass lever, 3/4" HB bypass, 1" HB inlet	24 gpm (90.8 lpm)	290 psi (20 bar)	3 lbs. (1.4 kg)
3	9910-KIT1990	9910-D252	One adjustable relief valve, one pressure/bypass selector, 5/8" HB bypass port and 3/8" HB outlet	6 gpm (22.7 lpm)	290 psi (20 bar)	1 lb. (0.5 kg)
4	9910-GS40GI	9910-D30 & 9910-D50	Pressure gauge, one adjustable high pressure relief valve, one complete bypass lever, two 1/2" HB outlets with individual shut-offs, and 3/4" hose barb bypass; Remote mounting kit: 9910-KIT1741	21 gpm (79.5 lpm)	580 psi (40 bar)	3.5 lbs. (1.6 kg)
5	9910-GR40	9910-D303 & 9910-D403	Pressure gauge, adjustable high pressure relief valve, complete bypass lever, 2-1/2" pressure gauge, two 1/2" hose barb outlets with individual shut-offs, and 5/8" hose barb bypass; Remote mounting kit: 9910-KIT1741	11 gpm (42 lpm)	580 psi (40 bar)	2 lbs. (0.9 kg)
6	9910-RM40	9910-D503	Pressure gauge, one adjustable high pressure relief valve, one complete bypass knob, two 1/2" HB outlets with individual shut-offs, and 1" hose barb bypass; Remote mounting kit: 9910-KIT1897 (Includes: mounting bracket, bolts, and hose barb)	24 gpm (90.8 lpm)	580 psi (40.0 bar)	3.5 lbs. (1.6 kg)
7	9910-GS50GI	9910-D813, 9910-D1064, 9910-D1265 & 9910-D1516	Pressure gauge, one adjustable high pressure relief valve, one complete bypass lever, three 1/2" HB outlets with individual shut-offs, and 1" hose barb bypass; Remote mounting kit: 9910-KIT1742 (Includes: mounting bracket, bolts, and hose barb)	48 gpm (181.7 lpm)	725 psi (50 bar)	8.5 lbs. (3.6 kg)
8	9910-VDR50	9910-D813, 9910-D1064 & 9910-D1265	Pressure gauge, one adjustable high pressure relief valve, one complete bypass lever, two 1/2" HB outlets with individual shut-offs, and 1" hose barb bypass; For additional ball valve, order Part Number 9910-130491	35 gpm (132.5 lpm)	725 psi (50 bar)	3.5 lbs. (1.6 kg)
9	3300-0087	9910-D70, 9910-D115, 9910-D135 & 9910-D160	One built-in relief valve, one 1" HB inlet, three 3/4", 1/2" and 3/8" HB outlets with individual shut-offs; Model-0088 includes a main bypass lever	42.5 gpm (160.9 lpm)	290 psi (20 bar)	7 lbs. (3.2 kg)
	3300-0088					7.75 lbs. (3.5 kg)
10	3300-0082	9910-D250	Pressure gauge, one built-in adjustable relief valve, one main shut-off and complete bypass lever, four 3/4" HB outlets with individual shut-offs, and 1-1/2" hose barb bypass	66 gpm (249.8 lpm)	290 psi (20 bar)	18 lbs. (8.2 kg)
11	9910-BMH50	9910-DBS110 9910-DBA110, 9910-DBS140 9910-DBA140, 9910-DBS160 9910-DBA160,	Directional control unit with working pressure regulating valve, single lever for partial or total closure and discharge and glycerine-bath pressure gauge with colored dial	41 gpm (155.2 lpm)	725 psi (50 bar)	6.6 lbs. (3.0 kg)
12	9910-GH50	9910-DBS200, & 9910-DBA200	Working pressure regulating valve, bypass control lever and glycerine-bath pressure gauge with colored dial	52.8 gpm (200 lpm)	725 psi (50 bar)	8.25 lbs. (3.7 kg)

# Demand vs Bypass Pump

## Demand Pump

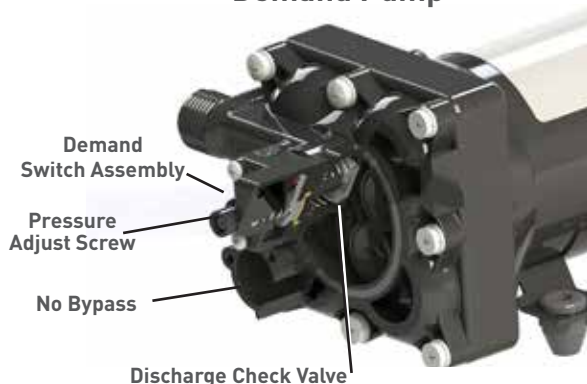

### Common Uses:

Applications with a set flow and pressure requirement. Example: Spray wands on spot sprayers.

### How it Works:

When the operator shuts off the wand, pressure in the line increases to a set point and the pressure switch shuts off the motor. A check valve inside the pump keeps trapped pressure in the line. When the wand is turned back on, pressure in the line decreases. The pressure falls below the set point that then restarts the pump.

### Sizing the Pump:

Select a pump with a pressure and flow point that is matched to the orifice size in the wand.

#### Pros:

- Saves wear and tear on the pump
- Extends the service life of the battery

#### Cons:

- Can be difficult to use with variable rate hand operated spray wands & guns

## Bypass Pump

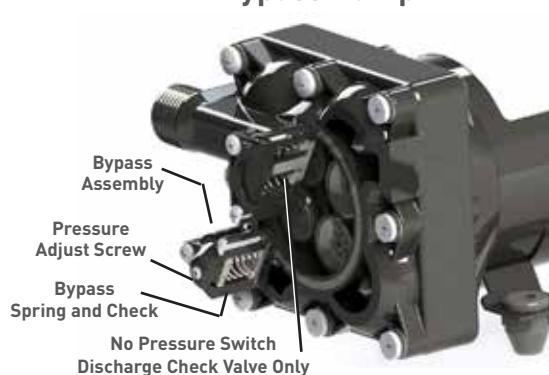

### Common Uses:

Applications where a wide range of flows and pressures may be required. Example: Spray bar with multiple nozzles, all controlled independently.

### How it Works:

The pump continues to run regardless of pressure in the system. For the spray bar example, the flow rate is different when one nozzle is turned on as opposed to having two or more turned on. As nozzles are turned off, excess flow is bypassed within the pump.

### Sizing the Pump:

Size the pump for the maximum flow rate required with all nozzles spraying.

#### Pros:

- Prevents on/off cycling of pump which can lead to early failure

#### Cons:

- If the discharge valve is closed for too long, overheating and damage can occur

- Constant amp draw can reduce battery power life

# Shurflo® 5000 Series Diaphragm Pump

## 5 GPM Bypass and Automatic-Demand Pumps 12 VDC



Bypass



Demand

The field-proven Shurflo 5.3 gpm [20.1 L/min] pump delivers 3.8 gpm at 40 psi [14.4 L/min at 2.75 bar] with current draw of 14 amps. This pump is designed with a Santoprene® diaphragm for chemical resistance and maximum life, as well as Viton® valves for maximum chemical resistance. Also included is a built-in pressure switch, set at 60 PSI [4.14 bar], which protects the pump in the event of dead-heading. The pump is available in the same footprint as other Shurflo pumps, allowing users to upgrade to a higher performance on existing installations.

- Field-proven pump head design
- Driven by a 12-volt, sealed motor
- Self-priming up to 8 feet [2.4 m]
- Santoprene® diaphragm for chemical resistance and maximum life
- Viton® valves provide maximum chemical resistance
- Automatic demand versions with built-in pressure switch, set at 60 psi [4.14 bar], protects the pump in the event of dead-heading
- Bypass versions set at 90 psi (5.86 bar), protects the pump in the event of dead heading
- Available in the same footprint as other Shurflo pumps, allowing users to upgrade to a higher performance on existing installations

### Order Information - Bypass 12VDC

Part Number	Max GPM	Max LPM	Max PSI	Max BAR	Port Size	Max Draw
5059-3611-D011	5.3	20.1	90	6.2	1/2" npsm*	20.9
5059-3610-D011	5.3	20.1	90	6.2	1/2" NPTF	20.9

\* 1/2" -14 American National Standard Straight Pipe Thread

\*\* For retail box: change "-D011" to "-D012"

### Bypass 12VDC

Model	PSI	GPM	BAR	L/min	Amps
5059-3611-D011 5059-3610-D011	0	5.3	0	20.1	6.5
	10	4.7	.7	17.8	9.0
	20	4.3	1.4	16.3	10.2
	30	4.1	2.1	15.5	12.0
	40	3.4	2.8	12.9	13.5
	50	2.6	3.4	9.8	15.2
	60	1.8	4.1	6.8	16.9
	70	1.1	4.8	4.2	18.5
	80	0.4	5.5	1.5	20.1
	90	0.0	6.2	0.0	20.9

### Order Information - Demand 12VDC

Part Number	Max GPM	Max LPM	Max PSI	Max BAR	Port Size	Max Draw
5059-1311-D011	5.3	20.1	60	3.4	1/2" npsm*	17.0
5059-1310-D011	5.3	20.1	60	3.4	1/2" NPTF	17.0

\* 1/2" -14 American National Standard Straight Pipe Thread

\*\* For retail box: change "-D011" to "-D012"

### Demand 12VDC

Model	PSI	GPM	BAR	L/min	Amps
5059-1311-D011 5059-1310-D011	0	5.3	0	20.1	6.5
	10	4.7	.69	17.8	9.0
	20	4.3	1.38	16.3	11.8
	30	4.1	2.07	15.5	12.4
	40	3.8	2.75	14.4	14.0
	50	3.6	3.45	13.6	15.4
	60	3.4	4.14	12.9	17.0

# Shurflo® 8000 Series Diaphragm Pump

## Automatic-Demand Pumps 12 VDC



The 8000 Series diaphragm pump is Shurflo's most widely used agriculture pump. Viton® valve material assures maximum chemical resistance. The unique conical valve design delivers high flow rates at maximum discharge pressures, making the 8000 Series the pump of choice for sprayers used on the farm or around the yard. These 12 VDC pumps deliver up to 1.8 GPM [6.8 L/min] providing maximum performance in a wide range of applications.

- Self-priming up to 8 vertical feet [2.4m]
- Chemical-resistant materials
- Designed for heavy-duty spraying and fluid transfer applications
- Can run dry without damage
- Built-in check valve

### Order Information

Part Number	Max GPM	Max LPM	Max PSI	Max BAR	Port Size	Max Draw	Description
8000-343-236	1.2	4.5	60	4.1	3/8" NPT-Female	5.8	All Viton® Pump: Viton® valves, Viton® diaphragm, 60 PSI (4.1 bar) demand switch
8000-541-236*	1.0	3.8	60	4.1	3/8" NPT-Female	3.8	Lawn and Garden Pump: Viton® valves, Santoprene® diaphragm, 60 PSI (4.1 bar) demand switch
8000-542-136	1.2	4.5	60	4.1	1/2" MSPT-Male	6.0	Low Flow Standard Pump: Viton® valves, Santoprene® diaphragm, 60 PSI (4.1 bar) demand switch
8000-543-136	1.8	6.8	60	4.1	1/2" MSPT-Male	7.3	Standard Pump: Viton® valves, Santoprene® diaphragm, 60 PSI (4.1 bar) demand switch
8000-543-236*	1.8	6.8	50	3.4	3/8" NPT-Female	6.4	Standard Pump: Viton® valves, Santoprene® diaphragm, 60 PSI (4.1 bar) demand switch
8000-543-238	1.8	6.8	100	6.9	3/8" NPT-Female	8.7	High Pressure Pump: Viton® valves, Santoprene® diaphragm, 100 PSI (6.9 bar) demand switch
8000-543-138	1.8	6.8	100	6.9	1/2" MSPT-Male	8.7	High Pressure Pump: Viton® valves, Santoprene® diaphragm, 100 PSI (6.9 bar) demand switch
8000-543-936*	1.8	6.8	50	3.4	3/8" NPT-Female	6.4	Standard Pump w/Wire Harness: Viton® valves, Santoprene® diaphragm, prewired with two wire molded connectors, 60 PSI (4.1 bar) demand switch
8000-547-189	1.8	6.8	107	7.4	1/2" MSPT-Male	7.0	High Pressure Pump: Viton® valves, Santoprene® diaphragm, 100 PSI (6.9 bar) demand switch with internal bypass
8000-643-236	1.8	6.8	60	4.1	3/8" NPT-Female	6.8	Transfer Pump: Buna valves, Geolast® diaphragm, 60 PSI (4.1 bar) demand switch
8030-813-239	1.6	6.1	150	9.5	3/8" NPT-Female	12.0	High Pressure Pump: Viton® valves, Santoprene® diaphragm, 150 PSI (10.3 bar) demand switch

\* Packaged in quantities of 6. For single packs, replace "8000-" with "8009."

Viton® is a registered trademark of DuPont. Hypro® is a registered trademark of Pentair Ltd.

Model	PSI	BAR	GPM	L/min	Amps
8000-343-236	20	1.4	0.93	3.5	3.9
	40	2.8	0.84	3.2	4.9
	50	3.4	0.80	3.0	5.3
	60	4.1	0.76	2.9	5.8
8000-541-236	20	1.4	0.79	3.0	2.3
	30	2.1	0.75	2.8	2.8
	40	2.8	0.70	2.6	3.2
	60	4.1	0.62	2.3	3.8
8000-542-136	20	1.4	1.11	4.2	4.1
	40	2.8	0.98	3.7	5.1
	50	3.4	0.93	3.5	5.6
	60	4.1	0.90	3.4	6.0
8000-543-136	20	1.4	1.26	4.7	5.0
	40	2.8	1.14	4.3	6.2
	50	3.4	1.08	4.1	6.8
	60	4.1	1.02	3.9	7.3
8000-543-236	30	1.4	1.47	5.5	5.7
	40	2.8	1.41	5.3	5.8
	50	3.4	1.36	5.1	6.4
8000-543-238	20	1.4	1.45	5.5	4.2
	40	2.8	1.31	5.0	5.5
	60	4.1	1.22	4.6	6.5
	100	6.9	0.96	3.6	8.7
8000-543-138	20	1.4	1.45	5.5	4.2
	40	2.8	1.31	5.0	5.5
	60	4.1	1.22	4.6	6.5
	100	6.9	0.96	3.6	8.7
8000-543-936	30	1.4	1.47	5.5	5.7
	40	2.8	1.41	5.3	5.8
	50	3.4	1.36	5.1	6.4
8000-643-236	20	1.4	1.44	5.4	4.1
	40	2.8	1.33	5.0	5.4
	50	3.4	1.27	4.8	6.1
	60	4.1	1.22	4.6	6.8
8030-813-239	20	1.4	1.55	5.9	5.5
	30	2.1	1.49	5.6	6.2
	40	2.8	1.43	5.4	6.8
	80	5.4	1.20	4.5	9.1
	100	6.9	1.10	4.2	10.1
150	9.5	0.83	3.1	12.0	

# Shurflo® 8000 Series Diaphragm Pumps

## Bypass Pumps 12 VDC



8000-543-250

8000 Series internal bypass pumps are ideal for applications where an automatic demand switch is not desired. Pumps with bypass will continue to run without damage once the bypass pressure is reached. They incorporate a triple chamber design with Viton® elastomers to withstand the toughest applications. Perfect for spot sprayers, foam markers and transfer applications where smooth, consistent flow is needed.

- Self-priming up to 8 vertical feet [2.4m]
- Chemical-resistant materials
- Internal bypass
- Can run dry without damage

### Order Information

Part Number	Max GPM	Max LPM	Max PSI	Max BAR	Port Size	Max Draw	Description
8000-543-250*	1.8	6.8	50	3.4	3/8" NPT-Female	5.5	Standard Bypass Pump: Viton® valves, Santoprene® diaphragm, 45 PSI (3.1 BAR) internal bypass
8000-543-210	1.3	4.9	40	2.8	3/8" NPT-Female	5.5	Standard Bypass Pump: Viton® valves, Santoprene® diaphragm, 35 PSI (2.4 BAR) internal bypass
8000-543-220	1.5	5.7	60	4.1	3/8" NPT-Female	7.1	Standard Bypass Pump: Viton® valves, Santoprene® diaphragm, 60 PSI (4.1 BAR) internal bypass
8006-543-250	1.4	5.3	50	3.4	3/8" NPT-Female	5.5	Bypass Pump with Reversed Pumphead: Viton® valves, Santoprene® diaphragm, 45 PSI (3.1 BAR) internal bypass

\* Packaged in quantities of 6. For single packs, replace "8000-" with "8009."

Model	PSI	BAR	GPM	L/min	Amps
8000-543-250	20	1.4	1.30	4.9	4.0
	30	2.1	1.11	4.2	4.7
	40	2.8	0.69	2.6	5.2
	50	4.1	0.18	0.7	5.5
8000-543-210	10	0.7	1.28	4.8	3.8
	20	1.4	1.19	4.5	4.4
	30	2.1	1.07	4.0	5.0
	40	2.8	0.05	0.19	5.5
8000-543-220	10	0.7	1.52	5.7	3.8
	20	1.4	1.45	5.5	4.5
	30	2.1	1.39	5.3	5.2
	60	4.1	1.12	4.2	7.1
8006-543-250	10	0.7	1.40	5.3	3.4
	20	1.4	1.30	4.9	4.0
	40	2.8	0.69	2.6	5.2
	50	4.1	0.18	0.7	5.5

# Shurflo 8000 Series Diaphragm Pumps

## Bypass Pumps 12 VDC



8000-543-290

Designed to accommodate applications that have external pressure valves plumbed into the system.

- Self-priming up to 8 vertical feet [2.4m]
- Chemical-resistant materials
- 1/4" adapter for external bypass hook-up
- Can run dry without damage

### Order Information

Part Number	Max GPM	Max LPM	Max PSI	Max BAR	Port Size	Max Draw	Description
8000-543-290	1.8	6.8	100	6.9	3/8" NPT-Female	8.8	Front Adapter Pump: Viton® valves, Santoprene® diaphragm, 1/4" FNPT adapter mounted on switch ports

Model	PSI	BAR	GPM	L/min	Amps
8000-543-290	20	1.4	1.26	4.7	5.0
	40	2.8	1.14	4.3	6.2
	60	4.1	1.02	3.9	7.3
	80	5.5	0.93	3.5	8.0
	100	6.9	0.84	3.2	8.8

Viton® is a registered trademark of DuPont. Hypro® is a registered trademark of Pentair Ltd.

# Shurflo® 8000, 8090 and 8020 Series Diaphragm Pumps

## Bypass and Automatic-Demand Pumps 115 VAC and 230 VAC



8020-833-238

8000-533-250

These Shurflo 8000, 8090 and 8020 Series bypass and demand pumps provide the same reliability as the 12 VDC version, except in a 115 VAC or 230 VAC capacity. They are ideal in agricultural applications that require high pressure with flow rates up to 1.6 GPM [6.1 L/min] and low amp draw. They can be mounted in any position, are compact, and are designed for easy maintenance.

- Self-priming up to 8 vertical feet [2.4m]
- Built-in check valve
- Chemical-resistant materials
- Corded pump optional
- Can run dry without damage

### Order Information - Bypass 115 VAC

Part Number	Max GPM	Max LPM	Max PSI	Max BAR	Port Size	Max Draw	Description
8000-533-250	1.4	5.3	50	3.4	3/8" NPT-Female	0.54	Bypass Pump: Viton® valves, Santoprene® diaphragm, 45 PSI (3.1 bar) Internal Bypass
8020-503-250	1.5	5.7	40	2.8	3/8" NPT-Female	0.56	Bypass Pump with 6' Power Cord: Viton® valves, Santoprene® diaphragm, 45 PSI (3.1 bar) Internal Bypass

### Bypass 115 VAC

Model	PSI	BAR	GPM	L/min	Amps
8000-533-250	10	0.7	1.36	5.1	0.34
	30	2.1	1.05	4.0	0.46
	40	2.8	0.65	2.5	0.51
	50	3.4	0.19	0.7	0.54
8020-503-250	10	0.7	1.40	5.3	0.37
	20	1.4	1.30	4.9	0.44
	30	2.1	1.10	4.2	0.50
	40	2.8	0.80	3.0	0.56

### Order Information - Demand 115 VAC

Part Numbers	Max GPM	Max LPM	Max PSI	Max BAR	Port Size	Max Draw	Description
8000-533-236	1.4	5.3	60	4.1	3/8" NPT-Female	0.64	Standard Demand Pump: Viton® valves, Santoprene® diaphragm, 60 PSI (4.1 bar) demand switch
8020-513-236	1.5	5.7	60	4.1	3/8" NPT-Female	0.57	Standard Demand Pump: Viton® valves, Santoprene® diaphragm, 60 PSI (4.1 bar) demand switch with 6 ft (1.8m) power cord
8020-833-238	1.6	6.1	100	6.9	3/8" NPT-Female	0.95	High Pressure Pump with 6 ft. Power Cord: Viton® valves, Santoprene® diaphragm, 100 PSI (6.9 bar) demand switch
8030-863-239	1.5	5.7	150	9.7	3/8" NPT-Female	1	High Pressure Pump: Viton® valves, Santoprene® diaphragm, 150 PSI (10.3bar) demand switch

### Demand 115 VAC

Model	PSI	BAR	GPM	L/min	Amps
8000-533-236	20	1.4	1.15	4.3	0.46
	40	2.8	0.97	3.7	0.55
	50	3.4	0.91	3.4	0.60
	60	4.1	0.85	3.2	0.64
8020-513-236	20	1.4	1.15	4.8	0.40
	40	2.8	0.96	4.1	0.49
	50	3.4	0.90	3.6	0.54
	60	4.1	0.84	3.5	0.57
8020-833-238	20	1.4	1.32	5.0	0.45
	40	2.8	1.14	4.3	0.58
	60	4.1	1.07	4.0	0.70
	100	6.9	0.91	3.4	0.95
8030-863-239	20	1.4	1.24	4.7	0.45
	60	4.1	1.04	3.9	0.66
	120	8.3	0.77	2.9	0.92
	150	9.7	0.63	2.4	1.00

### Order Information - Bypass 230 VAC

Part Numbers	Max GPM	Max LPM	Max PSI	Max Bar	Port Size	Max Draw	Description
8090-802-289	1.2	4.5	80	5.5	3/8" NPT Female	0.56	Bypass Pump: Viton® valves, Santoprene® diaphragm, 80 PSI (5.5 bar) Internal Bypass
8095-902-260	1.5	5.7	100	6.9	3/8" NPT Female	0.56	Bypass Pump: EPDM valves, Santoprene® diaphragm, 100 PSI (6.9 bar) Internal Bypass

### Order Information - Demand & Demand/Bypass 230 VAC

Part Numbers	Max GPM	Max LPM	Max PSI	Max BAR	Port Size	Max Draw	Description
8090-212-246	1.2	4.5	60	4.1	3/8" NPT Female	0.34	Standard Demand Pump: EPDM valves, Santoprene® diaphragm, 60 PSI (4.1 bar) demand switch
8090-801-278	1.3	4.9	100	6.9	3/8" NPT Female	0.56	Demand/Bypass Pump: Viton® valves, Santoprene® diaphragm, 80 PSI (5.5 bar) Internal Bypass, 100 PSI (6.9 bar) demand switch
8090-902-278	1.4	5.3	100	5.5	3/8" NPT Female	0.56	Demand/Bypass Pump: EPDM valves, Santoprene® diaphragm, 80 PSI (5.5 bar) Internal Bypass, 100 PSI (6.9 bar) demand switch

Viton® is a registered trademark of DuPont. Hypro® is a registered trademark of Pentair Ltd.

# Shurflo® 8007 Series Diaphragm Pumps

## Bypass and Automatic-Demand 12 VDC with Electrical Package



8007-543-850  
(Front and Back Shown)

These models include an aesthetically-pleasing molded assembly, housing a rocker-type manual switch with international on/off switch symbols. Wiring is neatly routed into the molded assembly through form fitting entries and strain relieved inside the housing. Fused versions come with an automotive-type fuse housed under a snug fitting cap marked "fuse." Non-fused versions have a raised section.

- Self-priming up to 8 vertical feet [2.4m]
- Chemical-resistant materials
- Internal bypass option
- Can run dry without damage
- Built-in on/off switch included
- 2 pin connector on power leads
- Available with or without integral fuse
- Rocker switch protected from the elements by a clear boot

### Order Information -Bypass 12VDC

Part Number	Max GPM	Max LPM	Max PSI	Max BAR	Port Size	Max Draw	Description
8007-543-850	1.8	6.8	50	3.4	3/8" NPT-Female	5.5	Bypass Pump w/Electrical Package: Viton® valves, Santoprene® diaphragm, 45 PSI (3.1 bar) bypass, Manual on/off switch 2 pin connector and fuse

### Bypass 12VDC

Model	PSI	BAR	GPM	L/min	Amps
8007-543-850	10	0.7	1.40	5.3	3.4
	20	1.4	1.30	4.9	4.0
	30	2.1	1.11	4.2	4.7
	40	2.8	0.69	2.6	5.2
	50	3.4	0.18	0.7	5.5

### Order Information -Demand 12VDC

Part Number	Max GPM	Max LPM	Max PSI	Max BAR	Port Size	Max Draw	Description
8007-591-236	1.0	3.8	50	3.4	3/8" NPT-Female	3.7	Demand Pump w/Electrical Package: Viton® valves, Santoprene® diaphragm, 60 PSI (4.1 bar) Demand Switch Manual on/off switch 2 pin connector (8007-543-836 includes fuse)
8007-593-836	1.8	6.8	50	3.4	3/8" NPT-Female	6.4	
8007-543-836	1.8	6.8	50	3.4	3/8" NPT-Female	6.4	

### Demand 12VDC

Model	PSI	BAR	GPM	L/min	Amps
8007-591-236	30	2.1	0.74	2.8	2.9
	40	2.8	0.69	2.6	3.2
	50	3.4	0.65	2.5	3.7
8007-593-836	30	2.1	1.47	5.5	5.3
	40	2.8	1.41	5.3	5.8
	50	3.4	1.36	5.1	6.4
8007-543-836	30	2.1	1.47	5.5	5.3
	40	2.8	1.41	5.3	5.8
	50	3.4	1.36	5.1	6.4

Viton® is a registered trademark of DuPont. Hypro® is a registered trademark of Pentair Ltd.



# Shurflo® 2087 Series Diaphragm Pumps

## Automatic-Demand Pump 12 VDC with Electrical Package



These models include an aesthetically-pleasing molded assembly, housing a rocker-type manual switch with international on/off switch symbols. Wiring is neatly routed into the molded assembly through form fitted entries and strain relieved inside the housing.

- Self-priming up to 12 vertical feet [3.7m]
- Chemical-resistant materials
- Can run dry without damage
- Rocker switch protected from the elements by a clear boot
- Built-in on/off switch included
- 2 pin connector on power lead

### Order Information

Part Number	Max GPM	Max LPM	Max PSI	Max BAR	Port Size	Max Draw	Description
2087-593-135 †	3	11.4	50	3.4	1/2" MSPT* Male	8	Standard Demand Pump: Viton® valves, Santoprene® diaphragm, 45 PSI (3.1 bar) demand switch

Model	PSI	BAR	GPM	L/min	Amps
2087-593-135	10	0.7	2.80	10.6	5.3
	20	1.4	2.69	10.2	5.5
	30	2.1	2.36	8.9	6.7
	40	2.8	2.05	7.8	7.7
	50	3.4	1.42	5.4	8.0

\* 1/2" - 14 National American Straight Pipe Thread

† Packaged in quantities of 6. For single pack, replace "135" with "435."

# Shurflo 2088 Series Diaphragm Pumps

## Automatic-Demand Pump 12 VDC



Shurflo 2088 Series diaphragm pumps deliver reliable performance in high flow, moderate pressure applications. They are used in a variety of spot spraying, multi-nozzle spraying and fertilizer drip applications that require flows of up to 3.6 GPM [13.6 L/min]. They are available in a variety of chemical-resistant materials.

- Self-priming up to 12 vertical feet [3.7m]
- Chemical-resistant materials
- Can run dry without damage
- Automatic demand
- Built-in check valve (varies by model) prevents back flow of fluid into the solution tank
- Continuous duty motor on fin-cooled version

### Order Information

Part Number	Max GPM	Max LPM	Max PSI	Max BAR	Port Size	Max Draw	Description
2088-313-145	3.6	13.6	40	2.8	1/2" MSPT* Male	9.5	Standard Pump: with fin cooled motor Viton® valves, Santoprene® diaphragm, 45 PSI (3.1 bar) demand switch
2088-443-144	3.5	13.2	45	3.1	1/2" MSPT* Male	9.1	Standard Pump: Santoprene® valves, Santoprene® diaphragm, 45 PSI (3.1 bar) demand switch
2088-343-135†	3	11.4	40	2.8	1/2" MSPT* Male	7.7	Standard Pump: Viton® valves, Santoprene® diaphragm, 45 PSI (3.1 bar) demand switch

Model	PSI	BAR	GPM	L/min	Amps
2088-313-145	10	0.7	3.09	11.7	6.4
	20	1.4	2.82	10.7	7.6
	30	2.1	2.49	9.4	8.7
	40	2.8	2.15	8.1	9.5
2088-443-144	10	0.7	2.83	10.7	5.8
	20	1.4	2.56	9.7	7.0
	30	2.1	2.31	8.7	8.0
	40	2.8	2.02	7.6	9.1
2088-343-135	10	0.7	2.80	10.6	5.3
	20	1.4	2.69	10.2	5.5
	30	2.1	2.36	8.9	6.7
	40	2.8	2.05	7.8	7.7

\* 1/2" - 14 National American Straight Pipe Thread

† Packaged in quantities of 6. For single pack, replace "135" with "435."

Viton® is a registered trademark of DuPont. Hypro® is a registered trademark of Pentair Ltd.

# Shurflo® 2088 Series Diaphragm Pumps

## No Control Pumps 12 VDC



2088-343-500

Shurflo 2088 Series diaphragm pumps deliver reliable performance in high flow, moderate pressure applications. They are used in a variety of spraying and transferring applications that require flows of up to 3.3 GPM [12.5 L/min]. They are available in a variety of chemical-resistant materials. They can be mounted in any position and are designed for easy maintenance.

- Self-priming up to 12 vertical feet [3.7m]
- Chemical-resistant materials
- Can run dry without damage
- Built-in check valve (may vary by models) prevents back flow of fluid through the pump

### Order Information

Part Number	Max GPM	Max LPM	Max PSI	Max BAR	Port Size	Max Draw	Description
2088-343-170	3.3	12.5	50	3.4	1/2" MSPT* Male	9.1	Front Adapter Pump with Electrical Package: Viton® valves, Santoprene® diaphragm, 1/4" FPT adapter mounted on switch port, built-in on/off power switch, fuse holder pre-wired w/2-wire molded connector, no demand switch
2088-343-500	3.3	12.5	50	3.4	1/2" MSPT* Male	10.1	Front Adapter Pump: Viton® valves, Santoprene® diaphragm, 1/4" FPT adapter mounted on switch port, no demand switch

Model	PSI	BAR	GPM	L/min	Amps
2088-343-170	10	0.7	3.00	11.3	5.0
	30	2.1	2.38	9.0	7.5
	40	2.8	2.14	8.1	8.3
	50	3.4	1.86	7.0	9.1
2088-343-500	10	0.7	2.79	10.6	5.8
	30	2.1	2.26	8.6	8.3
	40	2.8	1.99	7.5	9.3
	50	3.4	1.69	6.4	10.1

\* 1/2" - 14 National American Straight Pipe Thread

# Shurflo 2088 Series Diaphragm Pumps

## Automatic-Demand Pumps 115 & 230 VAC



2088-394-144

These Shurflo 2088 Series pumps offer the same reliability as the 12 VDC version except in 115 or 230 VAC capacity. They are used in a variety of spot spraying, mini-bulk transfer and fertilizer applications that require flows of up to 3.2 GPM [12.1 L/min]. They are available in a variety of chemical-resistant materials.

- Self-priming up to 12 vertical feet [3.7m]
- Chemical-resistant materials
- Can run dry without damage
- Automatic demand
- Built-in check valve (may vary by model) prevents back flow of fluid into the solution tank

### Order Information

Part Number	Max GPM	Max LPM	Max PSI	Max BAR	Port Size	Max Draw	Description
2088-394-144	3	11.4	40	2.8	1/2" MSPT* Male	0.7	115 VAC Pump with 6' power cord: Viton® valves, Santoprene® diaphragm, 45 PSI (3.1 bar) demand switch
2088-394-154	3.2	12.1	40	2.8	1/2" MSPT* Male	0.98	115 VAC Pump: Viton® valves, Santoprene® diaphragm, 45 PSI (3.1 bar) demand switch
2088-564-144	3.0	11.3	50	3.4	1/2" MSPT* Male	0.6	230 VAC Pump: Santoprene® valves, Santoprene® diaphragm, 45 PSI (3.1 bar) demand switch

Model	PSI	BAR	GPM	L/min	Amps
2088-394-144	10	0.7	2.40	9.1	.55
	20	1.4	2.20	8.3	.60
	30	2.1	1.90	7.2	.65
	40	2.8	1.60	6.0	.70
2088-394-154	10	0.7	2.71	10.2	.65
	20	1.4	2.41	9.1	.77
	30	2.1	2.10	8.0	.89
	40	2.8	1.84	7.0	.98
2088-564-144	10	0.7	2.80	10.6	0.35
	20	1.4	2.50	9.5	0.45
	30	2.1	2.20	8.3	0.50
	40	2.8	2.00	7.6	0.55
	50	3.4	1.70	6.4	0.60

\* 1/2" - 14 National American Straight Pipe Thread

Viton® is a registered trademark of DuPont. Hypro® is a registered trademark of Pentair Ltd.

# Shurflo® 166 Series Diaphragm Pumps

## Air-Driven Pumps



166-200-36

The Shurflo 166 air-operated demand pumps employ a dual diaphragm design, with a patented fast action switching mechanism allowing for consistent flow and pressure. They are built for the toughest pumping applications and are available in a variety of elastomers that allow them to be compatible with most caustic or acidic fluids. Ideal for chemical transfer, liquid fertilizer injection and agricultural spraying. 2 chamber dual diaphragm

- Positive displacement
- On-demand operation
- Chemical-resistant polypropylene body
- 30 to 60 PSI [2.1-4.1 bar]

### Order Information

Part Number	Max GPM	Max LPM	Max PSI	Max BAR	Description
166-200-36	0.6	2.3	30-60	2.1-4.1	Viton® valves and diaphragm
166-200-46	0.6	2.3	30-60	2.1-4.1	Buna valves and diaphragm
166-200-56	0.6	2.3	30-60	2.1-4.1	EPDM valves and diaphragm
166-200-57	0.6	2.3	30-60	2.1-4.1	Santoprene® valves and diaphragm

# Shurflo Power Twin Pump

## Demand Pumps 12VDC



4211-035

Take all the performance and features of the time-tested 2088 series, double it, and the result is the high-flow Power Twin. Delivers an open flow of 6.25 GPM [23.7 L/min] at a mere 8.7 amps. At 40 PSI [2.8 bar], it delivers 3.5 GPM [13.2 L/min] and draws only 17.2 amps. One of the most efficient high-flow self-priming pumps available today, the Power Twin is excellent for transferring, light-duty spraying, and use as a 1:1 proportioning pump.

- Up to 6.25 GPM [23.7 L/min]
- Thermally-protected motor with heat sink
- Self-priming up to 7 vertical feet [2.13 m]
- Quiet, balanced operation
- Long-life pressure switch
- Intake/Discharge manifold optional

### Order Information

Part Number	Max GPM	Max LPM	Max PSI	Max BAR	Port Size	Max Draw	Description
4111-035	6.25	23.7	40	2.8	1/2" MPT	17.2	Viton® valves, Santoprene® diaphragm, 45 PSI (3.1 bar) demand switch, manifold with 5/8" barb ports
4211-035	6.25	23.7	40	2.8	1/2" MPT	17.2	Viton® valves, Santoprene® diaphragm, 45 PSI (3.1 bar) demand switch
94-389-00	Manifold Kit 5/8" barb [2] per pump						
94-389-01	Manifold Kit 3/4" barb [2] per pump						

Model	PSI	BAR	GPM	L/min	Amps
4111-035	0	0	6.25	23.5	8.7
	10	0.7	5.7	21.6	12.2
	20	1.4	5.0	19.0	14.5
	30	2.1	4.3	16.2	16.1
	40	2.8	3.5	13.2	17.2
4211-035	0	0	6.25	23.5	8.7
	10	0.7	5.7	21.6	12.2
	20	1.4	5.0	19.0	14.5
	30	2.1	4.3	16.2	16.1
	40	2.8	3.5	13.2	17.2

Viton® is a registered trademark of DuPont. Hypro® is a registered trademark of Pentair Ltd.

# Shurflo® 9300 Series Submersible Pumps

24 VDC



## 902-100 Controller Features:

Boost your DC solar pump's performance by up to 30%. Controller optimizes your solar water pumping system by translating the current and voltage available from your photovoltaic panels, into a combination that is better matched to that needed by the pump. With the optional float switch installed, the controller will automatically stop pumping when the reservoir is full.

- \* Operates on 24 VDC
- \* Increases daily water output up to 30%
- \* System starts pumping earlier in the morning
- \* System stops pumping later in the evening
- \* Protects pump from low or high volume conditions
- \* Terminals for float switch

The Shurflo 9300 series pump offers a solution to your remote water pumping needs. It's rugged, durable and built to last. This pump delivers a steady 1.0 GPM [3.8 L/min] operating at 100 PSI [6.9 bar] maximum at 230 feet [70.1m]. It incorporates a unique, waterblocked cable connector that is impervious to water leakage and condensation problems preventing waterwicking. Great for applications in livestock watering, irrigation, ponds, islands, remote homes and cabins

- Fits wells 4 inches [10.2 cm] in diameter and larger
- Accepts a variety of jacketed cables from your power source
- Runs dry without damage
- Corrosion-proof housing with stainless steel fasteners
- Long-life, 24 VDC operation
- Quick disconnect for easy installation and service

## 902-200 Controller Features:

Includes all 902-100 features plus:

- \* Switch selectable for 12 VDC or 24 VDC operation
- \* Manual Pump On / Off switch for easy pump maintenance
- \* Watertight enclosure and cable inlets
- \* Includes high/low water level monitor mode with probes and cable so the pump will not run when the well water is too low

## Order Information

Part Number	Max GPM	Max LPM	Max Draw	Description
9325-043-101	1.8	6.8	4.1	EPDM valves, Santoprene® diaphragm

Model	Description	Max. Array Input Voltage		Min. Startup Voltage		Shutdown Voltage	Max. Output Current
		12V	24V	12V	24V		
902-100 (LCB-GO)	9300 DC Pump Controller	45 V	N/A	25 V	N/A	28 V	5 Amps
902-200 (LCB-G)	9300 DC Pump Controller	45 V	N/A	25 V	12.5 V	28 V	7 Amps

Model	Vertical Lift				Solar Array	Current
	Feet	Meters	GPH	LPH	Watts	Amps
9325-043-101	20	6.1	117	443	58	1.5
	60	18.3	109	413	78	2.1
	100	30.5	103	390	99	2.6
	140	42.7	99	375	115	3.1
	180	54.9	93	352	135	3.6
	230	70.1	82	310	155	4.1

# Shurflo 3000 Series Submersible Pumps

12 VDC



## Order Information

Part Number	Max GPM	Max LPM	Max PSI	Max BAR	Max Draw
3000-350	2.5	9.5	10	0.7	7.4

Model	PSI	BAR	Dischg. Ft of Head	GPM	L/min	Amps
3000-350	0	0.0	0.0	3.8	14.4	6.5
	5	0.3	11.5	3.4	12.9	7.1
	10	0.7	23.0	2.5	9.5	7.4

The 3000 Series is suitable for a variety of uses from pumping water to changing oil in cars, trucks and farm equipment. Pumps incorporate thermal overload protection.

Not intended for use with flammable liquids or in flammable environments.

- Self-priming to 7.5 feet [2.3m] vertical
- Maximum head of 28 feet [8.5m] (12 PSI [.83 bar])
- Liquid temps from 40° F to 185° F [4.4°C to 85°C]
- Thermal overload protection
- Stainless steel shaft
- BUNA-N impeller and lip seal
- Built-in reverse switch and 8 foot [2.4m] cable with battery clips

# Shurflo® SLV Series Diaphragm Pumps

## 12 and 24 VDC Demand Pumps



SLV10-AA48  
(Front and Back Shown)

The Shurflo SLV is ideal for low volume, intermittent-duty applications requiring a compact pump with low power consumption. Unique design has no metals in the fluid path for maximum chemical resistance. Pump features include automatic demand operation and elastomers that handle a wide variety of chemicals. Perfect for low volume spraying and transfer. Cost effective yet with high performance and reliability; the SLV offers tremendous value.

- Automatic demand; 25 PSI [1.72 bar] on/40 PSI [2.8 bar]
- Self-priming up to 2.5 vertical feet [.76 m]
- Long-life pressure switch
- Thermally-protected ball bearing motor with splash-proof housing
- Internal fan radiates heat; external heat sink not required
- Integral on/off switch optional

### Order Information - Automatic Demand Pumps 12 VDC

Part Number	Max GPM	Max LPM	Max PSI	Max BAR	Port Size	Max Draw	Description
SLV10-AA40	1	3.8	30	2.1	3/8" Barb	2.5	Viton® valves, Santoprene® diaphragm, 40 PSI [ 2.8 bar] demand switch, Integral on/off switch included
SLV10-AA41	1	3.8	30	2.1	3/8" Barb	2.5	Viton® valves, Santoprene® diaphragm, 40 PSI [ 2.8 bar] demand switch
SLV10-AA48*	1	3.8	30	2.1	3/8" Barb	2.5	Viton® valves, Santoprene® diaphragm, 40 PSI [ 2.8 bar] demand switch, Manual switch and 2 pin connector 12VDC

\* Packaged in quantities of 6, for single pack, add suffix "AB" (i.e.: SLV10-AA48-AB).

### Automatic Demand Pumps 12 VDC

Model	PSI	BAR	GPM	L/min	Amps
SLV10-AA40	3	0.2	0.90	3.4	1.8
	10	0.7	0.73	2.8	2.1
	20	1.4	0.62	2.3	2.3
SLV10-AA41	30	2.1	0.49	1.9	2.5
	3	0.2	0.90	3.4	1.8
	10	0.7	0.73	2.8	2.1
SLV10-AA48	20	1.4	0.62	2.3	2.3
	30	2.1	0.49	1.9	2.5
	20	1.4	0.62	2.3	2.3

### Order Information - Automatic Demand Pump 24 VDC

Part Number	Max GPM	Max LPM	Max PSI	Max BAR	Port Size	Max Draw	Description
SLV10-AB41	1	3.8	30	2.1	3/8" Barb	1.23	Viton® valves, Santoprene® diaphragm, 40 PSI [ 2.8 bar] demand switch

### Automatic Demand Pump 24 VDC

Model	PSI	BAR	GPM	L/min	Amps
SLV10-AB41	3	0.2	0.90	3.4	0.89
	10	0.7	0.73	2.8	1.00
	20	1.4	0.62	2.3	1.15
	30	2.1	0.49	1.9	1.23

### Order Information - No Control Transfer Pump 12 VDC

Part #	Max GPM	Max LPM	Max PSI	Max BAR	Port Size	Max Draw	Description
SLV10-HA01	1	3.8	30	2.1	3/8" Barb	2.5	Viton® valves, Geolast® diaphragm, No demand switch

### No Control Transfer Pump 12 VDC

Model	PSI	BAR	GPM	L/min	Amps
SLV10-HA01	3	0.2	0.90	3.4	1.8
	10	0.7	0.73	2.8	2.1
	20	1.4	0.62	2.3	2.3
	30	2.1	0.49	1.9	2.5

Viton® is a registered trademark of DuPont. Hypro® is a registered trademark of Pentair Ltd.

# Shurflo® Accessories



## Drill Pump

Attaches to any standard 1/4" [6.35 mm] drill motor. Ideal for pumping water from appliances, aquariums, water beds, sinks, toilets or drums. Includes a 1/4" [6.35 mm] oil probe that easily allows the transfer of oil from cars, trucks, lawn and garden equipment. Not intended for use with flammable liquids or in flammable environments.

- Self-priming to 8 feet [2.4m] vertical
- Pumps liquids 40° F to 120° F [4.4° C to 48.8° C]
- BUNA impeller and seals
- 1/4" [6.35 mm] shaft fits standard drills

## Order Information

Part Number	Max GPH	Max LPH	Port Size	Shaft Size
3010-000	200	757	3/4" (M) GHT	1/4"



## Oil Change System

Makes a messy job clean and easy. Simply install the oil probe in the engine oil dipstick tube, attach the battery clips, and flip the switch. Oil is safely removed and stored in the easy to carry container. Oil should be heated to 140°F for maximum pump efficiency.

- Complete with necessary tubing and oil storage container
- 8 foot cable with battery clips
- Thermal overload protection

## Order Information

Model	Description
8050-305-426	Oil Change System

## Heat Sink



## Order Information

Model	Description
34-007	5" [12.7 cm] Heat Sink to assist cooling in Continuous-duty applications
34-006	3" [7.6 cm] Heat Sink to assist cooling in Continuous-duty applications

## Bowl-Style Strainers



Model	Description
255-223	50 Mesh screen, 1/2" Barb Inlet x 1/2 NPSM Female Outlet
255-313	50 Mesh screen, 1/2" NPSM Male Inlet x 1/2 NPSM Female Outlet, EPDM O-ring
255-323	50 Mesh screen, 1/2" Barb Inlet x 1/2 NPSM Female Outlet, EPDM O-ring
255-646	50 Mesh screen, 3/8" x 3/8" MNPT Poly/Nylon, Viton® O-ring
255-568	50 Mesh screen, 3/8" x 3/8" MNPT Poly/Nylon, EPDM O-ring
255-613	50 Mesh screen, 1/2" NPSM Male Inlet x 1/2 NPSM Female Outlet, Viton® O-ring
255-623	50 Mesh screen, 1/2" Barb Inlet x 1/2 NPSM Female Outlet, Viton® O-ring
255-413	50 Mesh screen, 1/2" NPSM Male Inlet x 1/2 NPSM Female Outlet, Buna O-ring



### Barb Tee

Part Number	Description
8-126-00	1/2" [12mm] Barb Tee - Polypro



### Barb Tee X Pipe

Part Number	Description
T3812T	3/8" [10mm] MNPT-Male x 1/2" Barb Tee - Nylon
3T3812T	3/8" [10mm] MNPT-Male x 1/2" Barb Tee - Poly



### Swivel Hex Wingnut Straight

Part Number	Description
234-2916	1/2" [12mm] NPT-Female x 3/8" [10 mm] Barb - Polypro
234-2926	1/2" [12mm] NPT-Female x 1/2" [12 mm] Barb - Polypro
234-2936	1/2" [12mm] NPT-Female x 5/8" [16 mm] Barb - Polypro
234-2946	1/2" [12mm] NPT-Female x 3/4" [19 mm] Barb - Polypro



### Swivel Hexnut Elbow

Part Number	Description
234-3926	1/2" [12mm] NPT-Female x 1/2" [12 mm] Barb Swivel Hexnut Elbow - Polypro
244-3366	1/2" [12mm] NPT-Female x 1/2" [12 mm] NPT Male Swivel Hexnut Elbow Adaptor - Nylon
234-3916	1/2" [12mm] NPT-Female x 3/8" [10 mm] Barb Swivel Hexnut Elbow - Polypro
234-3946	1/2" [12mm] NPT-Female x 3/4" [19 mm] Barb Swivel - Polypro
234-3936	1/2" [12mm] NPT-Female x 5/8" [16 mm] Barb Swivel - Polypro

\*Fitting available only in nylon - CHECK COMPATIBILITY.



### Barbed X Pipe Straight

Part Number	Description
8-005-01	3/8" [10mm] NPT-Male x 3/8" [10 mm] Barb - Polypro
8-007-01	3/8" [10mm] NPT-Male x 1/2" [12 mm] Barb - Polypro
244-5126	1/2" [12mm] NPT-Male x 1/2" [12 mm] Barb - Nylon



### Barbed X Pipe Elbow

Part Number	Description
8-006-01	3/8" [10mm] NPT-Male x 3/8" [10 mm] Barb - Poly
244-6128	3/8" [10mm] NPT-Male x 1/2" [12 mm] Barb - Poly



8-145-00



8-150-01



8-205-00

### Adapters

Part Number	Description
8-145-00	3/8" [10mm] NPT-Male x 1/2" [12 mm] NPT-Male - Polypro
8-150-01*	1/2" [12mm] NPT-Female x 3/4" [19 mm] GHT (M) - Nylon
8-205-00	1/2" [12mm] NPT-Female x 1/2" [12 mm] NPT-Male - Aceryl

\*Fitting available only in nylon - CHECK COMPATIBILITY.

# Shurflo® AG Runner



The Shurflo AG Runner Transfer Pump System is designed to safely and accurately transfer bulk chemicals to the point of use.

**Features include:**

- Industry leading pump
- Portable
- Can be used with a variety of bulk containers
- Built for rugged service with a heavy-duty welded frame
- Simple and accurate flow indicator

**Order Information**

Part Number	Flow Meter Type	Description
SF-1100-PTS	Pump-mounted (FM-1100)	Chemical Transfer Pump with 12 VDC motor, 20 ft. (6 m) cable, alligator clips and in-line fuse (Part # SF-1100 - EPDM valves or SF-1105 - Viton® valves), electronic flow meter, 1-in. NPT x 12 ft. (3.7 m) EPDM discharge hose with ball valve/spout, and 1-in. NPT x 12 ft. (3.7 m) EPDM inlet hose with 1-in. elbow/ball valve/fitting assembly with locking cam arms
SF-1100-PTSi	Inline (FM-1100i)	
SF-1100-PTSi-00	No Flow Meter	
SF-1105-PTS	Pump-mounted (FM-1100)	
SF-1105-PTSi	Inline (FM-1100i)	

See Mini-Bulk Pump (pg. 103) for performance information.



# Shurflo Mini-Bulk Chemical Transfer System



Shurflo Mini-Bulk Chemical Transfer Pumps and Systems are designed specifically for chemical company tanks where the pump is integral to the tank. The SF-1100-REC system is mounted to any tank with a 9-inch, threaded opening. This system allows the pump to recirculate the suspended chemical components prior to transferring to the point of use.

**Order Information**

Part Number	Description
SF-1100-REC-DT	Chemical Transfer Pump with 12 VDC motor, 20 ft. (6 m) cable, alligator clips & in-line fuse (Part # SF-1100 - EPDM valves or SF-1105 - Viton® valves), in-line electronic flow meter (Part # FM-1100i), 1-in. NPT x 12 ft. (3.7 m) EPDM discharge hose with ball valve/spout, 3-way valve, tubing and fittings to allow tank recirculation, and 28" (71 cm) dip tube. (SF-1100-REC-DT only)
SF-1105-REC*	

See Mini-Bulk Pump (pg. 103) for performance information.

\* Does not come with 28" dip tube. To order dip tube separately use part number 2407-0002  
 Viton® is a registered trademark of DuPont. Hypro® is a registered trademark of Pentair Ltd.





# Shurflo® Mini-Bulk Pumps



The SF-1100 Series Bulk Chemical Pumps are the industry leader. They are designed for efficiency and power to handle highly viscous fluids. Servicing the SF-1100 series pump is a rare event, but if needed, it can be serviced quickly and easily with only a few hand tools.

- Specialized EPDM elastics or Viton® option
- 12 volt DC or 110 volt AC motor option
- 20 foot (6 m) cord with alligator clips and in-line fuse (DC version), 6 foot (1.8) cord (AC version)
- Weather protected on/off switch
- Internal bypass to protect the pump at shut-off
- 2" MNPT inlet, 1" FNPT outlet
- Capable of priming up to 12 feet (3.7 m)
- Max Viscosity: 600-880 Centipoise

## Order Information

Part Number	Valves	Motor
SF-1100	EPDM	12 VDC
SF-1100-110V	EPDM	110 VAC
SF-1105	Viton®	12 VDC

Model	PSI	BAR	GPM	L/min	Amps
SF-1100 and SF-1105	0	0.0	10.7	40	9.3
	5	0.3	10.1	38	10.3
	10	0.7	8.7	33	12.3
	15	1.0	7.6	29	13.9

# Shurflo Mini-Bulk Flow Meters



The FM-1100 Series Electronic Flow Meter is designed for accurate and easy measuring of transferred chemicals. The FM-1100 Series Flow Meter is an integral component for a complete bulk chemical transfer system.

- Max. flow of 20 gpm (76 lpm) (.5% accuracy after calibration)
- Max pressure of 120 psi (8.3 bar)
- Accurate nutating disk design
- Large LCD display makes meter reading easy from a distance
- Simple calibration steps and control button layout
- Long-life lithium battery
- Easy-to-service electronics and batteries
- Available in pump-mounted and hose-end configurations
- Max Viscosity: 600-880 Centipoise

## Order Information

Part Number	Max GPM	Max LPM	Max PSI	Max BAR	Description
FM-1100	20	76	120	8.3	Pump-mounted meter kit- 1" MNPT inlet & outlet
FM-1100i	20	76	120	8.3	Inline meter kit -1" FNPT inlet & outlet

Viton® is a registered trademark of DuPont. Hypro® is a registered trademark of Pentair Ltd.

# Shurflo® Mini-Bulk Kits, Parts, & Accessories



Part# 94-718-00



Part# 94-719-00



Part# 94-720-00  
& 94-720-05



Part# 94-721-00

## Mini-Bulk Pump Kits for SF-1100 Series

Part Number	Description
94-718-00	Motor assembly kit used in any SF-1100 series pumps. Kit includes a 12 VDC motor with integrated pump lower housing, built-in on-off switch, 20 foot (6 m) cable, alligator clips and in-line fuse ( Support bracket part # 84-1038-08)
94-719-00	Santoprene® diaphragm/lower housing/drive assembly - ready for installation
94-720-00	EPDM valve housing kits include a complete fully-assembled valve housing with o-ring seal* - ready for installation
94-720-05	Viton® valve housing kits include a complete fully-assembled valve housing with o-ring seal* - ready for installation
94-721-00	Polypropylene upper housing - includes o-ring seal* and pump head screws

\* Manufacturer recommends replacing the O-ring seal whenever the pump has been dismantled.



Part# 94-732-00



Part# 94-733-00



Part# 94-734-00



Part# 94-735-00



Part# 94-736-00

## Mini-Bulk Flow Meter Kits for FM-1100 Series

Part Number	Description
94-732-00	Flow meter electronics kit includes the front cover assembly and the electronic display with o-ring and batteries. Kit fits both pump-mounted and in-line meters [O-ring part # 5-040-154]
94-733-00	Flow meter housing seal cover kit includes the seal cover, o-ring and screws. Kit fits both pump-mounted and in-line meters. [O-ring part # 5-040-154]
94-734-00	Nutating chamber assembly, including o-ring seal. Kit fits both pump-mounted and in-line meters
94-735-00	90° meter housing with o-ring seal for pump-mounted flow meter. [O-ring part # 5-043-240]
94-736-00	Meter housing with o-ring seal for in-line flow meter. [O-ring part # 5-043-240]



Part# 3320-0064



Part# 8-727-00



Part# 94-712-00



Part# 94-716-00



Part# 94-717-00



Part# 94-723-00



Part# 94-724-00



Part# 94-725-00



Part# 94-737-00



Part# 94-738-00

## Other Mini-Bulk Parts & Accessories

Part Number	Description
3320-0064	Anti-flow back valve for EPA compliance
8-727-00	2 inch FNPT by 1 Inch FNPT polypropylene reducer coupling
94-712-00	2 inch male NPT by 2 inch female NPT street elbow fitting
94-716-00	1 inch NPT ball valve with spout
94-717-00	1 inch NPT x 12 foot EPDM discharge hose kit
94-723-00	Set of red and black alligator clips, including fuse holder
94-724-00	Replacement recirculation lid (Gasket part # 7-155-00)
94-725-00	Replacement recirculation cap
94-737-00	Recirculation system return hose kit - includes return hose and two hose clamps
94-738-00	Elbow, valve and coupling assembly - includes a 1 inch street elbow, 1 inch ball valve, and 1 inch bayonet tank coupling

# Stainless Steel, Triplex Plunger Pumps

## Model 2535S and 2545S



Shown with optional mounting kit (kit P/N 3430-0645)

### HEAD

- 100% 316 stainless steel head and two-piece manifold resists washout and corrosion
- Stainless steel fasteners provide additional protection against environmental elements
- Heavy-duty, high pressure seals and back-up washers are included to guard against corrosion and continuous duty fatigue
- Precision-machined, stainless steel valve and seats provide higher resistance to chemical attack
- Self-adjusting, spring-loaded, double V-packings maintain constant high pressure seal compression and extend seal and plunger life
- High density ceramic plungers increase the high pressure seal life
- Lifetime warranty on the stainless steel head

### BODY

- Oversized crankshaft, bearings and bronze connecting rod can handle the abuse of cold start-ups and intermittent operation
- Forged stainless steel plunger rod stepped between plunger guide and oil seal eliminates seal failure due to plunger rod wear
- Heavy-duty oil seals for longer life
- 5-year warranty on material & workmanship

### Order Information

Model Number	Max. GPM	Max. PSI	Max. RPM	Inlet Port	Outlet Port
2535S	38	1200	800	1-1/2" NPT	1" NPT
2545S	47	1200	800	1-1/2" NPT	1" NPT
3430-0645	Base Rail Kit				
3430-0699	2535S Mobile Repair Kit [See below for details]				

### 2535S

### U.S. Units

PSI	800		1000		1200	
	RPM	GPM	HP	RPM	GPM	HP
400	19.8	11.2	19.7	13.0	19.5	15.2
500	24.3	13.1	24.2	15.8	24.1	18.8
600	29.2	15.3	29.2	18.8	29.0	22.2
700	33.6	18.1	33.5	22.2	33.5	25.8
800	38.1	20.0	38.0	25.0	38.0	29.8

### 2535S

### Metric Units

BAR	55		69		83	
	RPM	L/m	Kw	RPM	L/m	Kw
400	75.0	8.4	74.6	9.7	73.8	11.3
500	92.0	9.8	91.6	11.8	91.2	14.0
600	110.5	11.4	110.5	14.0	109.8	16.6
700	127.2	13.5	126.8	16.6	126.8	19.2
800	144.2	14.9	143.8	18.6	143.8	22.2

### 2545S

PSI	800		1000		1200	
	RPM	GPM	HP	RPM	GPM	HP
400	24.4	13.2	24.2	16.0	24.1	18.9
500	30.4	16.1	30.3	19.6	30.2	23.1
600	36.5	19.2	36.5	23.2	36.4	27.5
700	42.1	22.1	42.1	27.1	42.0	32.3
800	46.8	25.1	46.8	30.4	46.7	36.1

### 2545S

BAR	55		69		83	
	RPM	L/m	Kw	RPM	L/m	Kw
400	92.4	9.8	91.6	11.9	91.2	14.1
500	115.1	12.0	114.7	14.6	114.3	17.2
600	138.2	14.3	138.2	17.3	137.8	20.5
700	159.4	16.5	159.4	20.2	159.0	24.1
800	177.2	18.7	177.2	22.7	176.8	26.9



### 2535S Mobile Repair Kit (Model Number: 3430-0699)

- Complete kit to rebuild the wet-end of the 2535S plunger pump
- Replace individual parts as needed or the entire wet-end
- As parts are used, reorder to keep mobile kit fully stocked
- Save time and money by having all the parts at your finger tips in an easy-to-carry case

#### Contains:

- 3010-0168 Tool Box
- 3430-0640 Valve Kit
- 3430-0641 Packing Kit
- 3430-0643 Plunger Seal Kit
- 3430-0644 Rod Oil Seal Kit
- 9910-621010 Bolt to Remove Valves
- 2160-0061 Anti-Seize Tube
- 3010-0250 Tool for Installing Cups
- L-1500 Repair Manual

# Forged Brass Head, Triplex Plunger Pumps

## Series 2400B-P



### HEAD

- Single-piece forged brass heads
- Quick and easy pump packing replacement
- Precision-machined stainless steel valve and seats provide higher resistance to chemical attack
- 100% ceramic plungers
- Dual low pressure packing design for improved priming capabilities
- Lifetime warranty on single-piece forged brass heads

### BODY

- Hypro's state-of-the-art, patented cartridge technology allows the crankcase oil seals and all wet-end seals to be easily serviced by removing only the pump head
- Hardened stainless steel lower plungers offer superior corrosion and wear resistance
- Longer lasting drive system with heavy-duty ball bearings
- Bronze piston guides give you larger bearing surface for extended life on oil seals and plungers
- 1" OD Solid Shaft
- Heavy-duty oil seals
- O-ring sealed dipstick
- Includes rail mounting kit
- 5-year warranty on material & workmanship

### Order Information - 2410B-P Series

Model Number	Max. GPM	Max. PSI	Max. RPM	Inlet Port	Outlet Port
2410B-P	4.4	2500	1725	3/4"	1/2"
2411B-P	5.3	2500	1725	3/4"	1/2"
2412B-P	5.9/4.0	2500	1725/1100	3/4"	1/2"
2413B-P	7.2	1800	1725	3/4"	1/2"
2414B-P	8.0/4.0	1800	1725/1100	3/4"	1/2"

Left-hand shaft extension - add suffix "L" - (i.e. 2410B-LP)

### Order Information - 2430B-P Series

Model Number	Max. GPM	Max. PSI	Max. RPM	Inlet Port	Outlet Port
2430B-P	4.3	3600	1725	3/4"	1/2"
2431B-P	5.1	3600	1725	3/4"	1/2"
2432B-P	5.8	3600	1725	3/4"	1/2"
2433B-P	7.1	2500	1725	3/4"	1/2"
2434B-P	7.9	2500	1725	3/4"	1/2"

Left-hand shaft extension - add suffix "L" - (i.e. 2430B-LP)

### 2410B-P

### U.S. Units

PSI	1000			1500		2000		2500	
	RPM	GPM	HP	GPM	HP	GPM	HP	GPM	HP
1000	2.7	1.9	2.7	2.7	2.6	3.4	2.6	4.1	
1150	3.1	2.1	3.1	3.0	3.0	3.8	3.0	4.6	
1450	3.9	2.6	3.9	3.7	3.8	4.8	3.7	5.8	
1725	4.6	3.1	4.5	4.4	4.4	5.7	4.4	6.9	

### 2411B-P

PSI	1000			1500		2000		2500	
	RPM	GPM	HP	GPM	HP	GPM	HP	GPM	HP
1000	3.2	2.4	3.2	3.3	3.1	4.2	3.1	5.1	
1150	3.7	2.5	3.7	3.6	3.6	4.6	3.6	5.6	
1450	4.6	3.1	4.6	4.4	4.5	5.7	4.5	7.0	
1725	5.3	3.7	5.3	5.2	5.2	6.7	5.1	8.1	

### 2412B-P

PSI	1000			1500		2000		2500	
	RPM	GPM	HP	GPM	HP	GPM	HP	GPM	HP
1000	3.6	2.7	3.5	3.6	3.5	4.6	3.5	5.6	
1150	4.1	2.9	4.1	4.1	4.0	5.2	4.0	6.4	
1450	5.1	3.7	5.1	5.1	5.0	6.6	5.0	8.0	
1725	5.9	4.2	5.9	5.9	5.8	7.7	5.7	9.4	

### 2410B-P

### Metric Units

BAR	69		103		138		172		
	RPM	L/m	Kw	L/m	Kw	L/m	Kw	L/m	Kw
1000	10.2	1.4	10.0	2.0	9.8	2.5	9.7	3.1	
1150	11.7	1.6	11.5	2.2	11.4	2.8	11.2	3.4	
1450	14.8	1.9	14.6	2.8	14.4	3.6	14.0	4.3	
1725	17.4	2.3	17.0	3.3	16.7	4.3	16.5	5.1	

### 2411B-P

BAR	69		103		138		172		
	RPM	L/m	Kw	L/m	Kw	L/m	Kw	L/m	Kw
1000	12.1	1.8	11.9	2.5	11.7	3.1	11.7	3.8	
1150	14.0	1.9	13.8	2.6	13.6	3.4	13.4	4.2	
1450	17.4	2.3	17.2	3.3	17.0	4.3	16.8	5.2	
1725	20.1	2.8	19.9	3.9	19.7	5.0	19.3	6.0	

### 2412B-P

BAR	69		103		138		172		
	RPM	L/m	Kw	L/m	Kw	L/m	Kw	L/m	Kw
1000	13.6	2.0	13.2	2.7	13.2	3.4	13.2	4.2	
1150	15.5	2.2	15.5	3.1	15.1	3.9	15.1	4.8	
1450	19.3	2.8	19.3	3.8	18.9	4.9	18.9	6.0	
1725	22.3	3.1	22.3	4.4	22.0	5.7	21.6	7.0	

### 2413B-P

### U.S. Units

PSI	500		1000		1500		1800	
	GPM	HP	GPM	HP	GPM	HP	GPM	HP
1000	4.4	1.8	4.4	3.0	4.3	4.2	4.3	5.0
1150	5.1	1.9	5.0	3.3	5.0	4.8	4.9	5.7
1450	6.3	2.5	6.2	4.2	6.1	5.9	6.1	7.0
1725	7.2	2.9	7.1	4.9	7.0	6.8	7.0	8.1

### 2414B-P

PSI	500		1000		1500		1800	
	GPM	HP	GPM	HP	GPM	HP	GPM	HP
1000	5.0	1.9	4.9	3.3	4.9	4.7	4.9	5.5
1150	5.7	2.0	5.6	3.7	5.6	5.3	5.6	6.3
1450	7.0	2.5	6.9	4.6	6.9	6.6	6.8	7.8
1725	7.9	3.0	7.8	5.3	7.7	7.6	7.7	8.8

### 2430B-P

PSI	1000		2000		3000		3600	
	GPM	HP	GPM	HP	GPM	HP	GPM	HP
1000	2.7	1.9	2.6	3.4	2.5	4.8	2.5	5.6
1150	3.1	2.1	3.0	3.8	2.9	5.4	2.8	6.4
1450	3.9	2.6	3.8	4.8	3.6	6.8	3.6	8.0
1725	4.6	3.1	4.4	5.7	4.3	8.1	4.2	9.5

### 2431B-P

PSI	1000		2000		3000		3600	
	GPM	HP	GPM	HP	GPM	HP	GPM	HP
1000	3.2	2.4	3.1	4.2	3.1	5.9	3.0	6.8
1150	3.7	2.5	3.6	4.6	3.5	6.6	3.5	7.7
1450	4.6	3.1	4.5	5.7	4.4	8.2	4.3	9.8
1725	5.3	3.7	5.2	6.7	5.0	9.5	5.0	11.2

### 2432B-P

PSI	1000		1500		3000		3600	
	GPM	HP	GPM	HP	GPM	HP	GPM	HP
1000	3.6	2.6	3.5	4.7	3.4	6.9	3.4	7.8
1150	4.1	2.9	4.0	5.3	4.0	7.5	3.9	8.8
1450	5.2	3.6	5.0	6.6	4.9	9.4	4.8	11.0
1725	6.0	4.2	5.8	7.6	5.7	10.9	5.6	12.8

### 2433B-P

PSI	1000		1500		2000		2500	
	GPM	HP	GPM	HP	GPM	HP	GPM	HP
1000	4.4	3.0	4.3	4.2	4.3	5.5	4.3	6.7
1150	5.0	3.3	5.0	4.8	4.9	6.2	4.9	7.6
1450	6.2	4.2	6.1	5.9	6.1	7.7	6.0	9.4
1725	7.1	4.9	7.0	6.8	7.0	8.9	6.9	10.8

### 2434B-P

PSI	1000		1500		2000		2500	
	GPM	HP	GPM	HP	GPM	HP	GPM	HP
1000	4.9	3.4	4.9	4.8	4.8	6.2	4.8	7.6
1150	5.6	3.8	5.6	5.4	5.5	7.1	5.5	8.5
1450	7.0	4.5	6.9	6.5	6.8	8.6	6.8	10.5
1725	7.9	5.3	7.8	7.7	7.8	10.0	7.7	12.1

### 2413B-P

### Metric Units

BAR	34		69		103		124	
	L/m	Kw	L/m	Kw	L/m	Kw	L/m	Kw
1000	16.7	1.3	16.7	2.2	16.3	3.1	16.4	3.7
1150	19.1	1.4	18.9	2.5	18.9	3.6	18.7	4.2
1450	23.7	1.8	23.5	3.1	23.1	4.4	23.2	5.2
1725	27.1	2.2	26.9	3.7	26.5	5.1	26.6	6.1

### 2414B-P

BAR	34		69		103		124	
	L/m	Kw	L/m	Kw	L/m	Kw	L/m	Kw
1000	18.9	1.4	18.5	2.5	18.5	3.5	18.5	4.1
1150	21.6	1.5	21.2	2.8	21.2	4.0	21.2	4.7
1450	26.5	1.9	26.1	3.4	26.1	4.9	25.7	5.8
1725	29.9	2.2	29.5	4.0	29.1	5.7	29.1	6.6

### 2430B-P

BAR	69		138		207		248	
	L/m	Kw	L/m	Kw	L/m	Kw	L/m	Kw
1000	10.2	1.4	9.8	2.5	9.5	3.6	9.5	4.2
1150	11.7	1.6	11.4	2.8	11.0	4.0	10.6	4.8
1450	14.8	1.9	14.4	3.6	13.6	5.1	13.6	6.0
1725	17.4	2.3	16.7	4.3	16.3	6.0	15.9	7.1

### 2431B-P

BAR	69		138		207		248	
	L/m	Kw	L/m	Kw	L/m	Kw	L/m	Kw
1000	12.1	1.8	11.7	3.1	11.7	4.4	11.4	5.1
1150	14.0	1.9	13.6	3.4	13.2	4.9	13.2	5.7
1450	17.4	2.3	17.0	4.3	16.7	6.1	16.3	7.3
1725	20.1	2.8	19.7	5.0	18.9	7.1	18.9	8.4

### 2432B-P

BAR	69		138		207		248	
	L/m	Kw	L/m	Kw	L/m	Kw	L/m	Kw
1000	13.6	1.9	13.2	3.5	12.9	5.1	12.9	5.8
1150	15.5	2.2	15.1	4.0	15.1	5.6	14.8	6.6
1450	19.7	2.7	18.9	4.9	18.5	7.0	18.2	8.2
1725	22.7	3.1	22.0	5.7	21.6	8.1	21.2	9.5

### 2433B-P

BAR	69		103		138		172	
	L/m	Kw	L/m	Kw	L/m	Kw	L/m	Kw
1000	16.7	2.2	16.3	3.1	16.3	4.1	16.3	5.0
1150	18.9	2.5	18.9	3.6	18.5	4.6	18.5	5.7
1450	23.5	3.1	23.1	4.4	23.1	5.7	22.7	7.0
1725	26.9	3.7	26.5	5.1	26.5	6.6	26.1	8.1

### 2434B-P

BAR	69		103		138		172	
	L/m	Kw	L/m	Kw	L/m	Kw	L/m	Kw
1000	18.5	2.5	18.5	3.6	18.2	4.6	18.2	5.7
1150	21.2	2.8	21.2	4.0	20.8	5.3	20.8	6.3
1450	26.5	3.4	26.1	4.8	25.7	6.4	25.7	7.8
1725	29.9	4.0	29.5	5.7	29.5	7.5	29.1	9.0

# Forged Brass Head, Triplex Plunger Pumps

## Series 2300B-P



### HEAD

- Single-piece forged brass heads
- Quick and easy pump packing replacement
- Precision-machined stainless steel valve and seats provide higher resistance to chemical attack
- 100% ceramic plungers
- Dual low pressure packing design for improved priming capabilities
- Lifetime warranty on single-piece forged brass heads

### BODY

- Hypro's state-of-the-art, patented cartridge technology allows the crankcase oil seals and all wet-end seals to be easily serviced by removing only the pump head
- Hardened stainless steel lower plungers offer superior corrosion and wear resistance
- Shafts Output:
  - 3/4" OD Solid Shaft – 2303B-P, 2304B-P, 2314B-P, 2330B-P, 2351B-P & 2345B-P
  - 3/4" OD Solid Shaft with M6 x 1" Tapped Thread for clutch installation – 2359B-P & 2340B-P
  - 3/4" OD Solid Shaft with 6" electric clutch assembly – 2359B-PY
  - 3/4" ID Hollow Shaft Flanged for direct couple to gasoline engines – 2354B-CP & 2331B-CP
- Heavy-duty oil seals
- O-ring sealed dipstick
- Includes rail mounting kit
- 5-year warranty on material & workmanship

### Order Information - 2303-P, 2304B-P, 2314B-P

Model Number	Max. GPM	Max. PSI	Max. RPM	Inlet Port	Outlet Port
2303B-P	3.1	1200	1725	1/2"	3/8"
2304B-P	4.2	1200	1725	1/2"	3/8"
2314B-P	4.0/3.0	1200	1450/1100	1/2"	3/8"

Left-hand shaft extension - add suffix "L" - (i.e. 2303B-LP)

### Order Information - 2330B-P, 2359B-P, 2351B-P, 2340B-P, 2354B-P

Model Number	Max. GPM	Max. PSI	Max. RPM	Inlet Port	Outlet Port
2330B-P	3.1	2500	1725	1/2"	3/8"
2359B-P*	3.5	3000	1725	1/2"	3/8"
2351B-P	4.0	3000	1725	1/2"	3/8"
2340B-P*	4.2	2500	1725	1/2"	3/8"
2345B-P	4.8	2500	1725	1/2"	3/8"

Left-hand shaft extension - add suffix "L" - (i.e. 2330B-LP)  
\*With m6 x 1" threaded shaft for Clutch installation

### Order Information - 2354B-CP, 2331B-CP

Model Number	Max. GPM	Max. PSI	Max. RPM	Inlet Port	Outlet Port
2354B-CP	2.7	2000	3450	1/2"	3/8"
2331B-CP	3.0	1500	3450	1/2"	3/8"

Left-hand shaft extension - add suffix "L" - (i.e. 2354B-CLP)

### Order Information - 2359B-PY

Model Number	Max. GPM	Max. PSI	Max. RPM	Inlet Port	Outlet Port
2359B-PY	3.5	3000	1725	1/2"	3/8"

Left-hand shaft extension - add suffix "L" - (i.e. 2359B-LPY)

### 2303B-P, 2304B-P, 2314B-P

### U.S. Units

PSI	500		700		1000		1200		
	RPM	GPM	HP	GPM	HP	GPM	HP	GPM	HP
1100		3.1	1.3	3.1	1.6	3.1	2.1	3.1	2.4
1450*		4.1	1.5	4.0	2.0	4.0	2.7	4.0	3.2
1725**		3.1	1.2	3.1	1.7	3.1	2.2	3.1	2.6
1725***		4.3	1.6	4.3	2.0	4.2	2.9	4.2	3.4

\* 2314 only, \*\* 2303 only, \*\*\* 2304 only

### 2303B-P, 2304B-P, 2314B-P

### Metric Units

RPM	34		48		69		83	
	L/m	Kw	L/m	Kw	L/m	Kw	L/m	Kw
1100	11.7	1.0	11.7	1.2	11.7	1.6	11.7	1.8
1450*	15.5	1.1	15.1	1.5	15.1	2.0	15.1	2.4
1725**	11.7	0.9	11.7	1.3	11.7	1.6	11.7	1.9
1725***	16.3	1.2	16.3	1.5	15.9	2.2	15.9	2.5

\* 2314 only, \*\* 2303 only, \*\*\* 2304 only

**2330B-P U.S. Units**

PSI	500		700		1000		1300		1500		2000	
RPM	GPM	HP	GPM	HP	GPM	HP	GPM	HP	GPM	HP	GPM	HP
1000	1.8	0.7	1.8	1.0	1.8	1.3	1.8	1.6	1.8	1.9	1.8	2.9
1450	2.7	1.0	2.7	1.4	2.6	1.9	2.6	2.3	2.6	2.7	2.5	4.2
1600	2.9	1.1	2.9	1.5	2.9	2.0	2.9	2.5	2.8	2.8	2.8	4.6
1725	3.1	1.2	3.1	1.7	3.1	2.2	3.1	2.8	3.1	3.2	3.0	5.0

**2340B-P**

PSI	500		700		1000		1300		1500		2000	
RPM	GPM	HP	GPM	HP	GPM	HP	GPM	HP	GPM	HP	GPM	HP
1000	2.5	1.0	2.5	1.3	2.5	1.8	2.5	2.2	2.5	2.5	2.4	4.0
1450	3.6	1.3	3.6	1.8	3.6	2.4	3.6	3.1	3.5	3.6	3.5	5.6
1600	4.0	1.5	4.0	1.9	3.9	2.7	3.9	3.3	3.9	3.8	3.8	6.2
1725	4.3	1.6	4.3	2.0	4.2	2.9	4.2	3.6	4.2	4.1	4.1	6.6

**2345B-P**

PSI	500		700		1000		1300		1500		2000	
RPM	GPM	HP	GPM	HP	GPM	HP	GPM	HP	GPM	HP	GPM	HP
1000	2.8	1.2	2.8	1.5	2.8	2.0	2.8	2.5	2.8	2.8	2.7	4.5
1450	4.1	1.7	4.1	2.2	4.0	2.9	4.0	3.7	4.0	4.1	4.0	6.5
1600	4.5	1.8	4.4	2.4	4.4	3.2	4.4	4.1	4.4	4.6	4.3	7.2
1725	4.8	2.0	4.7	2.6	4.7	3.4	4.7	4.4	4.7	4.9	4.6	7.6

**2359B-P, 2359B-PY**

PSI	500		700		1000		1300		2000		3000	
RPM	GPM	HP	GPM	HP	GPM	HP	GPM	HP	GPM	HP	GPM	HP
1000	2.1	1.0	2.1	1.6	2.1	2.0	2.1	2.3	2.0	2.8	2.0	4.0
1450	3.0	1.4	3.0	2.3	3.0	2.8	2.9	3.2	2.9	4.1	2.9	5.6
1600	3.3	1.6	3.3	2.6	3.3	3.2	3.3	3.4	3.2	4.4	3.2	6.2
1725	3.6	1.6	3.6	2.7	3.5	3.3	3.5	3.8	3.5	4.8	3.4	6.8

**2351B-P**

PSI	500		700		1000		1300		2000		3000	
RPM	GPM	HP	GPM	HP	GPM	HP	GPM	HP	GPM	HP	GPM	HP
1000	2.4	0.9	2.3	1.7	2.3	2.1	2.3	2.4	2.3	3.1	2.3	4.3
1450	3.4	1.4	3.4	2.4	3.4	3.0	3.3	3.4	3.3	4.4	3.2	6.3
1600	3.8	1.6	3.7	2.7	3.7	3.3	3.7	3.7	3.6	4.8	3.6	7.0
1725	4.0	1.7	4.0	2.9	4.0	3.5	4.0	4.0	3.9	5.1	3.8	7.4

**2331B-CP**

PSI	500		700		1000		1300		1500	
RPM	GPM	HP	GPM	HP	GPM	HP	GPM	HP	GPM	HP
1800	1.9	1.0	1.9	1.2	1.8	1.5	1.8	1.8	1.8	2.1
2600	2.7	1.4	2.6	1.7	2.6	2.2	2.6	2.7	2.5	3.0
2875	2.9	1.5	2.9	1.9	2.8	2.4	2.8	2.8	2.8	3.2
3450	3.4	1.9	3.4	2.2	3.3	2.8	3.3	3.4	3.3	3.8

**2354B-CP**

PSI	500		1000		1500		2000	
RPM	GPM	HP	GPM	HP	GPM	HP	GPM	HP
2800	2.4	1.3	2.3	2.0	2.3	2.7	2.2	3.4
3000	2.6	1.4	2.5	2.2	2.4	2.9	2.3	3.7
3200	2.7	1.6	2.6	2.4	2.6	3.2	2.5	3.9
3400	2.9	1.6	2.8	2.4	2.7	3.3	2.6	4.0

**2330B-P Metric Units**

BAR	34		48		69		90		103		172	
RPM	L/m	Kw	L/m	Kw	L/m	Kw	L/m	Kw	L/m	Kw	L/m	Kw
1000	6.8	0.5	6.8	0.7	6.8	1.0	6.8	1.2	6.8	1.4	6.8	2.2
1450	10.2	0.7	10.2	1.0	9.8	1.4	9.8	1.7	9.8	2.0	9.5	3.1
1600	11.0	0.8	11.0	1.1	11.0	1.5	11.0	1.9	10.6	2.1	10.6	3.4
1725	11.7	0.9	11.7	1.3	11.7	1.6	11.7	2.1	11.7	2.4	11.4	3.7

**2340B-P**

BAR	34		48		69		90		103		172	
RPM	L/m	Kw	L/m	Kw	L/m	Kw	L/m	Kw	L/m	Kw	L/m	Kw
1000	9.5	0.7	9.5	1.0	9.5	1.3	9.5	1.6	9.5	1.9	9.1	3.0
1450	13.6	1.0	13.6	1.3	13.6	1.8	13.6	2.3	13.2	2.7	13.2	4.2
1600	15.1	1.1	15.1	1.4	14.8	2.0	14.8	2.5	14.8	2.8	14.4	4.6
1725	16.3	1.2	16.3	1.5	15.9	2.2	15.9	2.7	15.9	3.1	15.5	4.9

**2345B-P**

BAR	34		48		69		90		103		172	
RPM	L/m	Kw	L/m	Kw	L/m	Kw	L/m	Kw	L/m	Kw	L/m	Kw
1000	10.6	0.9	10.6	1.1	10.6	1.5	10.6	1.9	10.6	2.1	10.2	3.4
1450	15.5	1.3	15.5	1.6	15.1	2.2	15.1	2.8	15.1	3.1	15.1	4.8
1600	17.0	1.3	16.7	1.8	16.7	2.4	16.7	3.1	16.7	3.4	16.3	5.4
1725	18.2	1.5	17.8	1.9	17.8	2.5	17.8	3.3	17.8	3.7	17.4	5.7

**2359B-P, 2359B-PY**

BAR	34		48		69		90		138		207	
RPM	L/m	Kw	L/m	Kw	L/m	Kw	L/m	Kw	L/m	Kw	L/m	Kw
1000	7.9	0.7	7.9	1.2	7.9	1.5	7.9	1.7	7.6	2.1	7.6	3.0
1450	11.4	1.0	11.4	1.7	11.4	2.1	11.0	2.4	11.0	3.1	11.0	4.2
1600	12.5	1.2	12.5	1.9	12.5	2.4	12.5	2.5	12.1	3.3	12.1	4.6
1725	13.6	1.2	13.6	2.0	13.2	2.5	13.2	2.8	13.2	3.6	12.9	5.1

**2351B-P**

BAR	34		48		69		90		138		207	
RPM	L/m	Kw	L/m	Kw	L/m	Kw	L/m	Kw	L/m	Kw	L/m	Kw
1000	9.1	0.7	8.7	1.3	8.7	1.6	8.7	1.8	8.7	2.3	8.7	3.2
1450	12.9	1.0	12.9	1.8	12.9	2.2	12.5	2.5	12.5	3.3	12.1	4.7
1600	14.4	1.2	14.0	2.0	14.0	2.5	14.0	2.8	13.6	3.6	13.6	5.2
1725	15.1	1.3	15.1	2.2	15.1	2.6	15.1	3.0	14.8	3.8	14.4	5.5

**2331B-CP**

BAR	34		48		69		90		103	
RPM	L/m	Kw	L/m	Kw	L/m	Kw	L/m	Kw	L/m	Kw
1800	7.2	0.7	7.2	0.9	6.8	1.1	6.8	1.3	6.8	1.6
2600	10.2	1.0	9.8	1.3	9.8	1.6	9.8	2.0	9.5	2.2
2875	11.0	1.1	11.0	1.4	10.6	1.8	10.6	2.1	10.6	2.4
3450	12.9	1.4	12.9	1.6	12.5	2.1	12.5	2.5	12.5	2.8

**2354B-CP**

BAR	34		69		90		103	
RPM	L/m	Kw	L/m	Kw	L/m	Kw	L/m	Kw
2800	9.1	1.0	8.7	1.5	8.7	2.0	8.3	2.5
3000	9.8	1.0	9.5	1.6	9.1	2.2	8.7	2.8
3200	10.2	1.2	9.8	1.8	9.8	2.4	9.5	2.9
3400	11.0	1.2	10.6	1.8	10.2	2.5	9.8	3.0

# Forged Brass Head, Duplex Plunger Pumps

## Series 2200B-P



### HEAD

- Single-piece forged brass heads
- Quick and easy pump packing replacement
- Precision-machined stainless steel valve and seats provide higher resistance to chemical attack
- 100% ceramic plungers
- Dual low pressure packing design for improved priming capabilities
- Lifetime warranty on single-piece forged brass heads

### BODY

- Hypro's state-of-the-art, patented cartridge technology allows the crankcase oil seals and all wet-end seals to be easily serviced by removing only the pump head
- Hardened stainless steel lower plungers offer superior corrosion and wear resistance
- Shafts Output:
  - 3/4" OD Solid Shaft – 2220B-P, 2221B-P, 2230B-P, 2231B-P
  - 5/8" ID Hollow Shaft with Torque Arm – 2220B-HP, 2221B-HP, 2230B-HP, 2231B-HP
  - 5/8" ID Hollow Shaft for direct couple to electric motors (NEMA 56C) – 2220B-AP, 2221B-AP, 2230B-AP, 2231B-AP
  - 3/4" ID Hollow Shaft Flanged for direct couple to gasoline engines – 2231B-CP
- Heavy-duty oil seals
- O-ring sealed dipstick
- Includes rail mounting kit
- 5-year warranty on material & workmanship

### Order Information

#### 2220B-P, 2221B-P, 2230B-P, 2231B-P

Model Number	Max. GPM	Max. PSI	Max. RPM	Inlet Port	Outlet Port
2220B-P	2.1	2000	1725	1/2"	3/8"
2221B-P	2.1	1500	3450	1/2"	3/8"
2230B-P	3.0	2000	1725	1/2"	3/8"
2231B-P	3.0	1500	3450	1/2"	3/8"

Left-hand shaft extension - add suffix "L" - (i.e. 2220B-LP)

### Order Information

#### 2220B-HP, 2221B-HP, 2230B-HP, 2231B-HP

Model Number	Max. GPM	Max. PSI	Max. RPM	Inlet Port	Outlet Port
2220B-HP	2.1	2000	1725	1/2"	3/8"
2221B-HP	2.1	1500	3450	1/2"	3/8"
2230B-HP	3.0	2000	1725	1/2"	3/8"
2231B-HP	3.0	1500	3450	1/2"	3/8"

Left-hand shaft extension - add suffix "L" - (i.e. 2220B-HLP)

### Order Information

#### 2220B-AP, 2221B-AP, 2230B-AP, 2231B-AP

Model Number	Max. GPM	Max. PSI	Max. RPM	Inlet Port	Outlet Port
2220B-AP	2.1	2000	1725	1/2"	3/8"
2221B-AP	2.1	1500	3450	1/2"	3/8"
2230B-AP	3.0	2000	1725	1/2"	3/8"
2231B-AP	3.0	1500	3450	1/2"	3/8"

Left-hand shaft extension - add suffix "L" - (i.e. 2220B-ALP)

### Order Information 2231B-CP

Model Number	Max. GPM	Max. PSI	Max. RPM	Inlet Port	Outlet Port
2231B-CP	3.0	1500	3450	1/2"	3/8"

Left-hand shaft extension - add suffix "L" - (i.e. 2231B-CLP)



**2220B-P, 2220B-AP, 2220B-HP U.S. Units**

PSI	500		700		1000		1300		1500		2000	
RPM	GPM	HP	GPM	HP	GPM	HP	GPM	HP	GPM	HP	GPM	HP
1000	1.2	0.5	1.2	0.7	1.2	0.9	1.2	1.1	1.2	1.2	1.2	1.6
1450	1.7	0.8	1.7	1.0	1.7	1.4	1.7	1.6	1.7	1.8	1.7	2.3
1600	1.9	0.9	1.9	1.1	1.9	1.5	1.9	1.8	1.9	2.1	1.9	2.7
1725	2.1	0.8	2.1	1.1	2.1	1.5	2.0	1.9	2.0	2.1	2.0	2.9

**2220B-P, 2220B-AP, 2220B-HP Metric Units**

BAR	34		48		69		90		103		138	
RPM	L/m	Kw	L/m	Kw	L/m	Kw	L/m	Kw	L/m	Kw	L/m	Kw
1000	4.5	0.4	4.5	0.5	4.5	0.7	4.5	0.8	4.5	0.9	4.5	1.2
1450	6.4	0.6	6.4	0.7	6.4	1.0	6.4	1.2	6.4	1.3	6.4	1.7
1600	7.2	0.7	7.2	0.8	7.2	1.1	7.2	1.3	7.2	1.6	7.2	2.0
1725	7.9	0.6	7.9	0.8	7.9	1.1	7.6	1.4	7.6	1.6	7.6	2.2

**2221B-P, 2221B-AP, 2221B-HP**

PSI	500		700		1000		1300		1500	
RPM	GPM	HP	GPM	HP	GPM	HP	GPM	HP	GPM	HP
1800	1.2	0.8	1.2	0.9	1.1	1.1	1.1	1.3	1.1	1.5
2600	1.7	1.1	1.7	1.4	1.6	1.5	1.6	1.9	1.6	2.2
2875	1.8	1.3	1.8	1.5	1.8	1.8	1.8	2.3	1.7	2.5
3450	2.1	1.6	2.1	1.9	2.1	2.1	2.1	2.6	2.0	2.9

**2221B-P, 2221B-AP, 2221B-HP**

BAR	34		48		69		90		103	
RPM	L/m	Kw	L/m	Kw	L/m	Kw	L/m	Kw	L/m	Kw
1800	4.5	0.6	4.5	0.7	4.2	0.8	4.2	1.0	4.2	1.1
2600	6.4	0.8	6.4	1.0	6.1	1.1	6.1	1.4	6.1	1.6
2875	6.8	1.0	6.8	1.1	6.8	1.3	6.8	1.7	6.4	1.9
3450	7.9	1.2	7.9	1.4	7.9	1.6	7.9	1.9	7.6	2.2

**2230B-P, 2230B-AP, 2230B-HP**

PSI	500		700		1000		1300		1500		2000	
RPM	GPM	HP	GPM	HP	GPM	HP	GPM	HP	GPM	HP	GPM	HP
1000	1.9	0.8	1.9	1.0	1.9	1.3	1.8	1.7	1.8	1.9	1.8	2.4
1450	2.7	1.1	2.7	1.4	2.7	2.0	2.7	2.4	2.7	2.8	2.7	3.6
1600	3.0	1.2	3.0	1.6	3.0	2.3	3.0	2.8	2.9	3.1	2.9	4.1
1725	3.2	1.4	3.2	1.9	3.2	2.4	3.1	3.0	3.1	3.4	3.1	4.4

**2230B-P, 2230B-AP, 2230B-HP**

BAR	34		48		69		90		103		138	
RPM	L/m	Kw	L/m	Kw	L/m	Kw	L/m	Kw	L/m	Kw	L/m	Kw
1000	7.2	0.6	7.2	0.7	7.2	1.0	6.8	1.3	6.8	1.4	6.8	1.8
1450	10.2	0.8	10.2	1.0	10.2	1.5	10.2	1.8	10.2	2.1	10.2	2.7
1600	11.4	0.9	11.4	1.2	11.4	1.7	11.4	2.1	11.0	2.3	11.0	3.1
1725	12.1	1.0	12.1	1.4	12.1	1.8	11.7	2.2	11.7	2.5	11.7	3.3

**2231B-P, 2231B-AP, 2231B-HP, 2231B-CP**

PSI	500		700		1000		1300		1500	
RPM	GPM	HP	GPM	HP	GPM	HP	GPM	HP	GPM	HP
1800	1.8	0.8	1.8	1.0	1.8	1.4	1.7	1.7	1.7	1.9
2600	2.5	1.2	2.5	1.5	2.5	2.0	2.5	2.4	2.5	2.7
2875	2.8	1.2	2.8	1.6	2.7	2.1	2.7	2.7	2.7	2.9
3450	3.2	1.5	3.2	1.9	3.2	2.5	3.2	3.2	3.1	3.5

**2231B-P, 2231B-AP, 2231B-HP, 2231B-CP**

BAR	34		48		69		90		103	
RPM	L/m	Kw	L/m	Kw	L/m	Kw	L/m	Kw	L/m	Kw
1800	6.8	0.6	6.8	0.7	6.8	1.0	6.4	1.3	6.4	1.4
2600	9.5	0.9	9.5	1.1	9.5	1.5	9.5	1.8	9.5	2.0
2875	10.6	0.9	10.6	1.2	10.2	1.6	10.2	2.0	10.2	2.2
3450	12.1	1.1	12.1	1.4	12.1	1.9	12.1	2.4	11.7	2.6

# Big Twin

## Models 5206C and 5206C-H



- Port sizes: 3/4" inlet, 3/4" outlet
- Max. fluid temperature: 140°F/60°C
- Pump shaft rotation: bi-rotational
- Cups: Leather standard [fabric-reinforced (F) and Buna-N (R) available]
- Recommended to be used with Pulsation Dampener 3375-0017-2
- Weight: 18 lbs./8.2 kg

### Order Information

Model Number	Max GPM	Max LPM	Max PSI	Max BAR	Max RPM	Shaft Output
5206C	8	30.3	400	27.6	800	1" solid shaft w/base
5206C-H	8	30.3	400	27.6	800	1-3/8" hollow shaft w/base
3430-0037	Leather cup kit					

Fabric Cups - Add Suffix "F" - (ie.: 5206C-F).  
 Buna-N Cups - Add Suffix "R" - (ie.: 5206C-R).

Pressure in PSI and BAR	GPM	HP	GPM	HP	GPM	HP	GPM	HP	GPM	HP	GPM	HP
	LPM	HP	LPM	HP	LPM	HP	LPM	HP	LPM	HP	LPM	HP
	⌀400 RPM		⌀500 RPM		⌀540 RPM		⌀600 RPM		⌀700 RPM		⌀800 RPM	
25 PSI	3.9	.26	4.9	.29	5.4	.31	6.0	.34	7.0	.40	8.0	.46
1.7 BAR	14.8	.26	18.5	.29	20.4	.31	22.7	.34	26.5	.40	30.3	.46
100 PSI	3.9	.40	5.0	.46	5.4	.50	6.0	.56	7.0	.65	7.9	.74
6.9 BAR	14.8	.40	18.9	.46	20.4	.50	22.7	.56	26.5	.65	29.9	.74
200 PSI	4.0	.66	5.0	.75	5.4	.81	6.0	.90	6.9	1.1	7.8	1.2
13.8 BAR	15.1	.66	18.9	.75	20.4	.81	22.7	.90	26.1	1.1	29.5	1.2
300 PSI	3.9	.89	5.0	1.1	5.3	1.2	5.9	1.3	6.9	1.5	7.7	1.7
20.9 BAR	14.8	.89	18.9	1.1	20.1	1.2	22.3	1.3	26.1	1.5	29.1	1.7
400 PSI	3.9	1.1	4.9	1.4	5.3	1.5	5.9	1.6	6.9	1.9	7.7	2.2
27.6 BAR	14.8	1.1	18.5	1.4	20.1	1.5	22.3	1.6	26.1	1.9	29.1	2.2

# Big Twin

## Models 5210C and 5210C-H



- Port sizes: 3/4" inlet, 3/4" outlet
- Max. fluid temperature: 140°F/60°C
- Pump shaft rotation: bi-rotational
- Cups: Leather standard [fabric-reinforced (F) and Buna-N (R) available]
- Recommended to be used with Pulsation Dampener 3375-0015-2
- Weight: 18 lbs./8.2 kg

### Order Information

Model Number	Max GPM	Max LPM	Max PSI	Max BAR	Max RPM	Shaft Output
5210C	10	37.5	400	27.6	600	1" solid shaft w/base
5210C-H	10	37.5	400	27.6	600	1-3/8" hollow shaft w/base
3430-0037	Leather cup kit					

Fabric Cups - Add Suffix "F" - (ie.: 5210C-F).  
 Buna-N Cups - Add Suffix "R" - (ie.: 5210C-R).

Pressure in PSI and BAR	GPM	HP	GPM	HP	GPM	HP	GPM	HP
	LPM	HP	LPM	HP	LPM	HP	LPM	HP
	⌀400 RPM		⌀500 RPM		⌀540 RPM		⌀600 RPM	
25 PSI	7.3	.39	8.9	.57	9.4	.66	10.0	.73
1.7 BAR	27.6	.39	33.7	.57	35.6	.66	37.9	.73
100 PSI	7.3	.69	8.9	.87	9.4	.94	9.9	1.10
6.9 BAR	27.6	.69	33.7	.87	35.6	.94	37.5	1.10
200 PSI	7.2	1.2	8.8	1.5	9.3	1.6	9.9	1.7
13.8 BAR	27.2	1.2	33.3	1.5	35.2	1.6	37.5	1.7
300 PSI	7.2	1.7	8.8	2.0	9.3	2.2	9.8	2.3
20.7 BAR	27.2	1.7	33.3	2.0	35.2	2.2	37.1	2.3
400 PSI	7.2	2.1	8.7	2.6	9.2	2.7	9.8	3.0
27.6 BAR	27.2	2.1	32.9	2.6	34.8	2.7	37.1	3.0

# Small Twin

## Series 5315, 5320, 5325 and 5330



- Port sizes: 1/2" inlet, 1/2" outlet
- Max. fluid temperature: 140°F/60°C
- Pump shaft rotation: bi-rotational
- Cups: Leather (-X) standard for 5300 Series [Buna-N (-RX), Teflon (-CX) available]
- Models require a pulsation dampener (such as a 3375-0012 pulse hose) on the discharge side
- Injector head available (sold separately part number 3396-0014)
- Weight: 10 lbs./4.5 kg

### Order Information

Model Number	Max GPM	Max LPM	Max PSI	Max BAR	Max RPM	Shaft Output
5315C-X	1.5	5.7	500	34.5	1800	5/8" OD solid shaft
5320C-X	2.2	8.3	500	34.5	1800	5/8" OD solid shaft
5325C-X	2.5	9.5	500	34.5	1800	5/8" OD solid shaft
5330C-X	3	11.4	500	34.5	1800	5/8" OD solid shaft
5315C-HX	1.5	5.7	500	34.5	1800	5/8" ID hollow shaft
5320C-HX	2.2	8.3	500	34.5	1800	5/8" ID hollow shaft
5325C-HX	2.5	9.5	500	34.5	1800	5/8" ID hollow shaft
5330C-HX	3	11.4	500	34.5	1800	5/8" ID hollow shaft

Buna-N - add suffix "R" - [ i.e. :5320C-RX]  
 Teflon - add suffix "C" - [ i.e. :5320C-CX]

Model Pressure in PSI and BAR	5315		5320		5325		5330	
	GPM	HP	GPM	HP	GPM	HP	GPM	HP
	LPM	HP	LPM	HP	LPM	HP	LPM	HP
	@1725 RPM		@1725 RPM		@1725 RPM		@1725 RPM	
50 PSI	1.56	.12	2.22	.21	2.56	.25	3.02	.37
3.4 BAR	5.9	.12	8.4	.21	9.7	.25	11.4	.37
100 PSI	1.52	.15	2.18	.28	2.54	.37	3.01	.49
6.9 BAR	5.8	.15	8.3	.28	9.6	.37	11.4	.49
200 PSI	1.50	.28	2.16	.43	2.52	.52	3.00	.74
13.8 BAR	5.7	.28	8.2	.43	9.3	.52	11.4	.74
300 PSI	1.47	.35	2.12	.57	2.50	.68	2.98	.92
20.7 BAR	5.6	.35	8.0	.57	9.5	.68	11.3	.92
400 PSI	1.45	.43	2.11	.71	2.10	.82	2.96	1.11
27.6 BAR	5.5	.43	8.0	.71	7.9	.82	11.2	1.11
500 PSI	1.44	.56	2.10	.83	2.44	.96	2.94	1.23
34.5 BAR	5.5	.56	7.9	.83	9.9	.96	11.1	1.23

# Small Twin

## Models 5324C and 5324C-H



- Port sizes: 1/2" inlet, 1/2" outlet
- Max. fluid temperature: 140°F/60°C
- Pump shaft rotation: bi-rotational
- Cups: Buna-N standard
- Model 5324 requires a pulsation dampener (such as a 3375-0012 pulse hose) on the discharge side
- Injector head available 3396-0006
- Weight: 11 lbs./5 kg

### Order Information

Model Number	Max GPM	Max LPM	Max PSI	Max BAR	Max RPM	Shaft Output
5324C	2.9	11.0	800	55.2	1800	5/8" OD solid shaft
5324C-H	2.9	11.0	800	55.2	1800	5/8" ID hollow shaft

Pressure in PSI and BAR	GPM	HP	GPM	HP	GPM	HP	GPM	HP	GPM	HP
	LPM	HP	LPM	HP	LPM	HP	LPM	HP	LPM	HP
	@600 RPM		@900 RPM		@1200 RPM		@1450 RPM		@1725 RPM	
100 PSI	.96	.12	1.51	.19	2.00	.28	2.42	.34	2.90	.40
6.9 BAR	3.6	.12	5.7	.19	7.6	.28	9.2	.34	11.0	.40
200 PSI	.94	.19	1.49	.30	1.98	.41	2.40	.50	2.89	.59
13.8 BAR	3.6	.19	5.6	.30	7.5	.41	9.1	.50	10.9	.59
300 PSI	.94	.26	1.48	.41	1.97	.55	2.38	.67	2.87	.80
20.7 BAR	3.6	.26	5.6	.41	7.5	.55	9.0	.67	10.9	.80
400 PSI	.95	.33	1.47	.50	1.96	.67	2.37	.83	2.85	1.00
27.6 BAR	3.6	.33	5.6	.50	7.4	.67	9.0	.83	10.8	1.00
500 PSI	.94	.39	1.47	.60	1.96	.81	2.36	.97	2.83	1.19
34.5 BAR	3.6	.39	5.6	.60	7.4	.81	8.9	.97	10.7	1.19
600 PSI	.93	.45	1.46	.69	1.95	.93	2.35	1.13	2.81	1.38
41.4 BAR	3.5	.45	5.5	.69	7.4	.93	8.9	1.13	10.6	1.38
700 PSI	.93	.52	1.46	.78	1.94	1.06	2.33	1.27	2.80	1.54
48.3 BAR	3.5	.52	5.5	.78	7.3	1.06	8.8	1.27	10.6	1.54
800 PSI	.93	.58	1.45	.87	1.93	1.16	2.32	1.42	2.79	1.69
55.2 BAR	3.5	.58	5.5	.87	7.3	1.16	8.8	1.42	10.6	1.69

# Small Twin

## Models 5321C, 5322C, 5321C-H and 5322C-H



- Port sizes: 1/2" inlet, 1/2" outlet
- Max. fluid temperature: 180°F/82°C
- Pump shaft rotation: bi-rotational
- Injector head available 3396-0006
- Models 5321 and 5322 require a pulsation dampener (such as a 3375-0012 pulse hose) on the discharge side
- Weight: 11 lbs./5 kg

### Order Information

Model Number	Max GPM	Max LPM	Max PSI	Max BAR	Max RPM	Shaft Output	Plunger Material
5321C	2.2	8.3	1000	68.9	1800	5/8" OD solid shaft	Stainless Steel
5322C	2.2	8.3	1000	68.9	1800	5/8" OD solid shaft	Ceramic
5321C-H	2.2	8.3	1000	68.9	1800	5/8" ID hollow shaft	Stainless Steel
5322C-H	2.2	8.3	1000	68.9	1800	5/8" ID hollow shaft	Ceramic

Pressure in PSI and BAR	GPM	HP	GPM	HP	GPM	HP	GPM	HP
	LPM	HP	LPM	HP	LPM	HP	LPM	HP
	@900 RPM		@1200 RPM		@1450 RPM		@1725 RPM	
100 PSI	1.1	0.2	1.5	.3	1.8	.4	2.2	.4
6.9 BAR	4.2	0.2	5.7	.3	6.8	.4	8.3	.4
300 PSI	1.1	.4	1.5	.5	1.8	.6	2.1	.7
20.7 BAR	4.2	.4	5.7	.5	6.8	.6	7.9	.7
500 PSI	1.1	.5	1.5	.6	1.8	.7	2.1	.8
34.5 BAR	4.2	.5	5.7	.6	6.8	.7	7.9	.8
700 PSI	1.1	.6	1.5	.8	1.8	.9	2.1	1.1
48.3 BAR	4.2	.6	5.7	.8	6.8	.9	7.9	1.1
1000 PSI	1.1	.8	1.4	1.0	1.8	1.2	2.1	1.4
69.0 BAR	4.2	.8	5.3	1.0	6.8	1.2	7.9	1.4

# Small Twin

## Model 53702



- Port sizes: 1/2" inlet, 1/2" outlet
- Max. fluid temperature: 180°F/82°C
- Pump shaft rotation: bi-rotational
- Plungers: polished ceramic
- Model 53702 requires a pulsation dampener (such as a 3375-0012 pulse hose) on the discharge side
- Inlet requirements: pressure feed 20-100 psi (1.4-6.9 bar)
- Weight: 11 lbs./5 kg

### Order Information

Model Number	Max GPM	Max LPM	Max PSI	Max BAR	Max RPM	Shaft Output
53702	2.2	8.3	1000	68.9	3450	5/8" ID hollow shaft

Pressure in PSI and BAR	GPM	HP
	LPM	HP
	@3450 RPM	
100 PSI	2.3	.4
6.9 BAR	8.7	.4
300 PSI	2.2	.7
20.7 BAR	8.3	.7
500 PSI	2.1	.9
34.5 BAR	8.0	.9
700 PSI	2.1	1.2
48.3 BAR	8.0	1.2
1000 PSI	2.0	1.5
69 BAR	7.6	1.5

# Small Twin

## Model 53703



- Max. fluid temperature: 180°F/82°C
- Port sizes: 1/2" inlet, 1/2" outlet
- Pump shaft rotation: bi-rotational
- Plungers: polished ceramic
- Model 53703 requires a pulsation dampener (such as a 3375-0012 pulse hose) on the discharge side
- Inlet requirements: pressure feed 20-100 psi (1.3 - 6.9 bar)
- Weight: 11 lbs./5 kg

### Order Information

Model Number	Max GPM	Max LPM	Max PSI	Max BAR	Max RPM	Shaft Output
53703	2.3	8.7	1000	68.9	3100	5/8" ID hollow shaft

Requires a Special Order Gas Engine With 5/8" Shaft

Pressure in PSI and BAR	GPM	HP
	LPM	HP
@3100 RPM		
100 PSI	2.3	0.4
6.9 BAR	8.7	0.4
300 PSI	2.2	.7
20.7 BAR	8.3	.7
500 PSI	2.1	.9
34.5 BAR	7.9	.9
700 PSI	2.1	1.2
48.3 BAR	7.9	1.2
1000 PSI	2.0	1.5
69.0 BAR	7.6	1.5

# Hydraulically-Driven Pressure Washers

Offering 3-4 gpm (11-15 lpm) Cleaning Power



- Anodized, die-cast aluminum crankcase
- Heavy-duty, corrosion-resistant brass manifold
- One-piece, forged-bronze connecting rods
- Stainless steel valves
- Hardened, stainless steel piston guides
- Solid ceramic plungers
- High pressure and low pressure packings of high-quality buna textile
- Heavy-duty, ball bearing supported crankshaft
- Sight glass and oil-level dipstick
- Hydraulic ports: 1/2" NPT inlet, 3/4" NPT outlet

The hydraulically-driven pressure washers are ideally suited for remote and explosion-proof environments where electricity cannot be used. These models are equipped with a hydraulic motor-driven, triplex plunger pump; and include an unloader, gauge, and quick disconnect. Some models include a chemical injector, 50' (15 m) pressure wash hose, trigger gun and insulated wand with adjustable Hi-Lo and Variable-Angle cleaning nozzle. Certain models are also equipped with a chemical injector.

Model Number	Max GPM	Max LPM	Max PSI	Max BAR	Hydraulic Motor Requirements				Description	Weight	
					GPM	LPM	PSI	BAR		LBS	KG
1802C*	3	11.4	1000	68.9	5	18.9	1300	89.6	Forged Brass Head Triplex Pumps with hydraulic motor, adjustable unloader, gauge, 1/2" NPT input, 3/8" quick disconnect output	38	17.2
1803C	3	11.4	1000	68.9	5	18.9	1300	89.6		28	12.7
1804C*	3	11.4	1500	103.4	8	30.3	1900	131	Forged Brass Head Triplex Pumps with hydraulic motor, chemical injector, adjustable unloader, gauge, 3/4" GH input, 3/8" quick disconnect output	41	18.6
1805C	3	11.4	1500	103.4	8	30.3	1900	131		26	11.8
1806C*	3	11.4	2000	137.9	11	41.6	1300	89.6		41	18.6
1807C	3	11.4	2000	137.9	11	41.6	1300	89.6		26	11.8
1824C*	4	15.1	1500	103.4	8.5	32.2	2000	137.9		49	22.2
1825C	4	15.1	1500	103.4	8.5	32.2	2000	137.9		33	14.9
1826C*	4	15.1	2000	137.9	8.5	32.2	2000	137.9		49	22.2
1827C	4	15.1	2000	137.9	8.5	32.2	2000	137.9		33	14.9

\* Includes 50 ft (15 m) hose and gun assembly

# Piston/Plunger Accessories

## Pressure-Activated 3 Port Unloaders



Model Number	Inlet/Outlet	Bypass	Pressure Range		Max GPM	Max LPM	Max Temp	Max Temp	Cup Material	Ref #
			PSI	Bar						
3390-0062D*	3/8" (M) NPT	1/4" (F) NPT	200-600	14-41	5	19	180° F	82° C	Buna-N	1
3390-0063D*			400-1000	28-69						
3390-0071D* <sup>T</sup>			400-1000	28-69						
3390-0067D*			800-1500	55-103						
3390-0072D* <sup>T</sup>			800-1500	55-103						
3390-0006	1/2" (F) NPT	1/2" (F) NPT	200-500	14-34	5	19	160° F	71° C	Buna-N	2
3390-0007			200-500	14-34	5	19			Leather	
3390-0037			300-1000	21-69	6	23			Buna-N/Teflon	
3390-0053	3/4" (F) NPT	3/4" (F) NPT	1000-2000	69-138	15	57	200° F	93° C	Buna-N	3

\* Recommended for use with 5300 Series pumps

<sup>T</sup> For close-coupled bypass operation with Hypro 2200 and 2300 Series PowerLine Plus pumps, bypass not NPT. Use only with 8000-0007 and 80000-0008.

## Pressure-Activated 3 or 5 Port Unloaders with Adjustment Knob



Model Number	# of Ports	Inlet/Outlet	Bypass	Max PSI	Max Bar	Max GPM	Max LPM	Max Temp	Max Temp	Cup Material	Ref #
3390-0079	3	3/8" (M)NPT	3/8" (F) NPT	2000	138	8	30	200° F	93° C	Buna-N	1
3390-0102	3	3/8" (M)NPT	1/4" (F)NPT	2600	179						2
3390-0076	3	3/8" (F)NPT	1/4" (F)NPT	3600	248						3
3390-0081	5	(2) 3/8" (F)NPT x 3/8" (F)NPT	(2) 1/4" (F)NPT	3600	248						4

## Pressure-Activated Unloader/Bypass Kits



Model Number	Inlet/Outlet	Pressure Range		Max GPM	Max LPM	Max Temp	Max Temp	Description
		PSI	Bar					
8000-0007	1/2" (F)NPT x 3/8" (M)NPT	400-1000	28-69	5	19	200° F	93° C	3 port unloader/bypass system with adjustable knob for 2200 and 2300 series PowerLine Plus Pumps.
8000-0008		800-1500	55-103					

## Closed-Coupled Unloaders



Model Number	Inlet/Outlet	Max PSI	Max Bar	Max GPM	Max LPM	Injector Orifice Range		Max Temp	Max Temp	Description
						GPM	LPM			
3390-0104/3A	1/2" (F)NPT x 3/8" (M)NPT	2600	180	8	30	2.0-3.2	7.6-12.1	200° F	93° C	2 port unloader/bypass system with built-in chemical injector and adjustable knob.

For 2200 & 2300 series PowerLine Plus pumps.

## Adjustable & Fixed Chemical Injectors



Model Number	Inlet/Outlet	Max PSI	Max Bar	GPM Range	LPM Range	Max Temp	Max Temp	Type	Materials	Ref #
3396-0034/1.8	3/8" (F)NPT x 3/8" (M)NPT	3200	220	0-2.9	0-11	200° F	93° C	Fixed	Forged brass body; Stainless Steel Ball & Spring	1
3396-0031/2.1				3.0-4.0	11-15			Adjustable		2
3396-0033/2.3				4.0-5.0	15-19			Fixed		1

# Piston/Plunger Accessories



## Power Adjustable Injector for 2200/2300 Pumps

Model Number	Inlet	Max PSI	Max Bar	GPM Range	LPM Range	Max Temp	Max Temp	Materials	For Models	Description
3396-0011	1/8" (F) NPT	1500	103	2.0-4.8	7.5-18	140° F	60° C	Brass & Stainless Steel	2200 & 2300	9-step calibrated metering
3396-0025		3000	207			160° F	71° C		2200B-P & 2300B-P	



## Power Adjustable Injector for 5300 Pump

Model Number	Inlet	Max PSI	Max Bar	GPM Range	LPM Range	Max Temp	Max Temp	Description	Materials	For Models
3396-0014	1/8" (F) NPT	500	34	1.5-3.0	5.7-11	140° F	60° C	9-step adjustable, needle-type metering assembly for precise metering of soaps and liquids	Cast iron cylinder head; brass and stainless steel internal components	5300CX
3396-0006		1000	69	2	7.5					5321 & 5342C

Replaces standard head on Series 5300 and 5321 pumps



## Regulator/Relief Valve - Provides smooth, constant pressure regulation

Model Number	Inlet/Outlet	Max PSI	Max Bar	Balanced Pressure		Max GPM	Max LPM	Max Temp	Max Temp	Materials
				PSI	Bar					
3300-0084	3/8" (F)NPT	2000	138	200-2000	14-138	7	26	160° F	71° C	Brass Body; Stainless Steel plunger & seat



## High Flow Pressure Regulator/Relief Valve for 2535S & 2545S Pumps

Model Number	Inlet/Outlet	Max PSI	Max Bar	Balanced Pressure		Max GPM	Max LPM
				PSI	Bar		
3300-0102	3/4" x 1/2"	2000	138	260-2000	18-138	53	200
3300-0103	1" x 1"						

## Thermal Relief Valve

Easy mount valve to safeguard pumps from damaging heat generated within recirculating water systems. Easy to service without removing.



Model Number	Inlet	Max PSI	Max Bar	Relief Temp	Relief Temp	Materials	Dimensions
3312-0004	1/2" (M) NPT	200	14	145° F	63° C	Brass, Stainless Steel & Buna-N	1-1/16" Hex x 1-11/16"
3312-0005*							1-1/16" Hex x 2-1/2"

\* 3/16" barb fittings

## Screw Couplings & Connecting Nipples



Model Number		Inlet	Max PSI	Max Bar	Max GPM	Max LPM	Max Temp	Max Temp
Screw Couplings	Connecting Nipples							
3341-0001	3341-0005	3/8" (F)NPT	3500	241	12	45	300° F	149° C
3341-0002	3341-0006	1/4" (F)NPT						
3341-0003	3341-0007	3/8" (M)NPT						
3341-0004	3341-0008	1/4" (M)NPT						

# Piston/Plunger Accessories



## C-Flange Kits

Model Number	Fits Motor	For Models
8000-0003	NEMA 56C, 143TC and 145TC	2200, 2300, 2350
8000-0010	NEMA 182TC and 184TC	2200, 2300, 2350
8000-0043	NEMA 213TC and 215TC	2200B-P & 2300B-P
8000-0017	NEMA 213TC and 215TC	2400 & 2430
8000-0018	NEMA 182TC and 184TC	2400 & 2430



## Pulsation Dampeners

These quality-built pulsation dampeners protect your system from damage due to pulsation and vibration. Choose the size and capacity that meets your system's needs. In most applications, the recommended dampener charge is 1/2 of the operating pressure with a 2-piston pump and 2/3 of the operating pressure with a 3-piston pump.

Model Number	Inlet	Charge PSI	Charge Bar	Max GPM	Max LPM	For Models	Ref #
3375-0015-x	1" (F)NPT	200-1000	14-69	35	132	2500 Series	1
3375-0017-x	1/2" (F)NPT			6	23	2000 Series	2

Note: Replace 'x' with maximum charge designation; Example: 3375-0015-8 = 800 psi, 3375-0017-7 = 700 psi  
Available in 100 psi increments from 200 psi to 1000 psi.



## Pulsation Dampener Checker

For testing the charge pressure in pulsation dampeners. The proper charge will ensure maximum life and performance of pressure systems.

Model Number	Connection	Max PSI	Max Bar
2642-0001	5/16" 32 UNEF (F) Thread	2000	138

## Pulse Hoses

Quality pulsation dampener hoses constructed of special Hi-Flex horizontally-braided hose.



Model Number	Length	Max PSI	Max Bar	Connection
3375-0008	24" (61 cm)	1500	103	3/8" (F)NPT x 3/8" (M)NPT
3375-0012	24" (61 cm)			3/8" (F)NPT x plugged end
3375-0021	25" (63.5 cm)			1/4" (M)NPT x plugged end

## Gear Boxes



Model Number	Inlet/Outlet	Max PSI	Max Bar	Max Temp	Max Temp	Description	Materials
8000-0015	3/8" (F)NPT x 3/8" (M)NPT	3200	220	200° F	93° C	1.8:1 gearbox kit for mounting 10 hp-18 hp gas engines with 1-1/8" solid shaft (Kohler engines)	Forged brass body; Stainless steel ball and spring
8000-0021						1.8:1 gearbox kit for mounting 8 hp-18 hp gas engines with 1" solid shaft (B&S and Honda engines)	



# Piston/Plunger Accessories



## Zinc-Plated Steel Port Adapters

Model Number	Port Openings			
	1 - End	2 - Gauge Port	3 - Side	4 - End
2404-0030	1/2" (M)NPT	1/4" (F)NPT	1/2" (F)NPT	1/2" (F)NPT
2404-0019	3/4" (M)NPT	1/4" (F)NPT	1/2" (F)NPT	3/4" (F)NPT



## Float Tank Strainer

Model Number	Tank Outlet Filter	Outlet
3800-0074	1/2"	1/2" (M)NPT



## Vacuum Switches

Model Number	Performance	Max Temp	Max Temp
2510-0001	VAC-ON: 1.5 Hg vac.	140° F	60° C
2510-0007	VAC-ON: 2.5 Hg vac.		
2510-0017	VAC-ON: 4.5 Hg vac.		

### Features

- Switches can be used with either AC or DC motors in the ratings shown
  - DC (32-115-230V): up to 1/2 hp
  - Single or 3 Phase at 110V: up to 2 hp
  - 220V: up to 2 hp
- VAC-ON switch automatically shuts off motor when liquid is depleted or vacuum drops to a specific level



## Pump Oil

Model Number	Size	Decriptions
2160-0038	1 qt. (12 per carton)	Specially-formulated pump oil
2160-0047	1 gallon (bulk)	
2160-0048	2-1/2 gallon (bulk)	

### Features

- Reduces scuff and wear in piston and plunger pumps
- Inhibits moisture that causes damage
- Prevents oxidation that could lead to sludge formation
- Resists foaming and aeration that can cause equipment to operate erratically and oil to oxidize
- Provides smooth pump operation in a variety of temperatures



## Pressure Switch

Model Number	Inlet	Max PSI	Max Bar	Max Temp	Max Temp	Voltage	Max Amp Vertical and Horizontal Mount
2510-0029	3/8" (M)NPT	3500	241	200° F	93° C	12-250V	15A

# Piston/Plunger Accessories



## Float Switch

Model Number	Inlet/Outlet	Max PSI	Max Bar	Max GPM	Max LPM	Max Temp	Max Temp	Voltage	Mount
2510-0030	3/8" (F)NPT x 3/8" (F)NPT	3500	241	7.8	30	180° F	82° C	12-250V	Vertical
2510-0031	3/8" (M)NPT x 3/8" (M)NPT								Horizontal



## Aluminum Line Strainer

Model Number	Inlet/Outlet	Max PSI	Max Bar	Max GPM	Max LPM	Housing Material	Screen Mesh	Bypass Hose Port
3350-0134	1/2" (F)BPS x 1/2" (M)BPS	100	7	8	30	Aluminum	50	G 1/4"



## Suction Strainer

Model Number	Size	Opening Size (ID)	Overall Diameter	Screen Mesh	Material
3350-0021	1/4" (ID) plastic tubing	.330"	1.25"	50	Stainless Steel Screen
3350-0022			1"		
3350-0033	5/8" (ID) x 61/64" (OD) garden hose	.940"	2.187"		
3800-0035	(F) garden hose end	.57"	1.016"		



## Chemical Injector Strainer

Model Number	Hose Barb	Material	Check Valve
3350-0126	1/4" & 3/8"	Chemical-resistant plastic body and components	Yes
3350-0127			No
3350-0128	1/4"	Corrosion-resistant stainless steel and brass construction	Yes

# Piston/Plunger Accessories

## Couplers



Inches	mm
1/8"	3.2 mm
3/16"	4.7 mm
1/4"	6.4 mm
1/2"	13 mm
5/8"	15.9 mm
3/4"	19 mm
7/8"	22.2 mm
15/16"	23.8 mm
1"	25.4 mm
1-1/8"	28.6 mm

**Note:**  
These couplers are designed for inch dimensional shafts and keys. Metric dimensions are for reference only (except for 2739-1009).

Series	Part Number	Description	Estimated Weight Each	
			US Units	Metric
2738 (2.0 hp limit)* Replaces L-075	2738-1001	1/2" coupling end, with 1/8" keyway	6 oz.	170 g
	2738-1002	5/8" coupling end, with 3/16" keyway	6 oz.	170 g
	2738-1003	3/4" coupling end, with 3/16" keyway	6 oz.	170 g
	2738-1004	7/8" coupling end, with 3/16" keyway	6 oz.	170 g
	2728-1001	Center disc	1 oz.	28 g
2739 (5.0 hp limit)* Replaces L-095	2739-1001	5/8" coupling end, with 3/16" keyway	11 oz.	312 g
	2739-1002	3/4" coupling end, with 3/16" keyway	11 oz.	312 g
	2739-1003	7/8" coupling end, with 3/16" keyway	11 oz.	312 g
	2739-1004	15/16" coupling end, with 1/4" keyway	11 oz.	312 g
	2739-1005	1" coupling end, with 1/4" keyway	11 oz.	312 g
	2739-1006	1-1/8" coupling end, with 1/4" keyway	11 oz.	312 g
	2739-1009	24 mm coupling end, with 8mm keyway	11 oz.	312 g
	2729-1001	Center disc	1 oz.	28 g
2741 (10.5 hp limit)* Replaces L-100	2741-1001	3/4" coupling end, with 3/16" keyway	1 lb. 5 oz.	595 g
	2741-1004	15/16" coupling end, with 1/4" keyway	1 lb. 5 oz.	595 g
	2741-1002	1" coupling end, with 1/4" keyway	1 lb. 5 oz.	595 g
	2741-1005	1-1/4" coupling end, with 1/4" keyway	1 lb. 5 oz.	595 g
	2741-1007	1-3/8" coupling end, with 5/16" keyway	1 lb. 5 oz.	595 g
	2741-1003	1-1/8" coupling end, with 1/4" keyway	1 lb. 5 oz.	595 g
	2729-1002	Center disc	1 oz.	28 g
2740 (18.0 hp limit)* Replaces L-110	2740-1001	3/4" coupling end, with 3/16" keyway	3 lbs. 11 oz.	1.67 kg
	2740-1002	1" coupling end, with 1/4" keyway	3 lbs. 8 oz.	1.59 kg
	2740-1005	1-3/8" coupling end, with 5/16" keyway	3 lbs.	1.4 kg
	2740-1007	1-1/8" coupling end, with 1/4" keyway	2 lbs. 15 oz.	1.33 kg
	2729-1003	Center disc	3 oz.	85 g

\* HP limit is electric motor hp at 1725 rpm for driving a steady uniform load. For an uneven load, stop-start and moderate shock loads, divide hp by a 1.5 service factor.

### Ordering Instructions:

To order one 1/2" x 3/4" Series 2738 coupling, specify the following:

Note: It is not necessary to order in complete sets, parts can be ordered individually.

Quantity	Part Number	Description
1	2738-1001	1/2" coupling end
1	2738-1003	3/4" coupling end
1	2728-1001	Center disc

# VERSA-TWIN 2130 Series Plunger Pumps



- Molded from Noryl GTX for chemical resistance against fertilizers, insecticides, chlorides, acids, and bleach
- Robust motor, ceramic plunger, and crank drive provide market-leading long life without servicing
- 4-point 1" NPT flynut-ready connections allow for greater flexibility in plumbing, easy installation and servicing, draining and maintenance
- 1" ports allow for single-sided inlet plumbing
- Available in standard models up to 4.0 GPM (15.1 L/min) & 300 PSI (20.7 BAR)

## Order Information

Model Number	Max GPM	Max L/min	Max PSI	Max BAR	Max RPM	Motor Type	Ports
2130P-D183	2.5	9.5	150	10.3	2200	¼ HP 12V DC Motor, 20 amps	1" MNPT
2130P-D355	2.8	10.6	300	20.7	2000	½ HP 12V DC Motor, 35 amps	
2130P-D359	3.9	14.8	200	13.8	2000	½ HP 12V DC Motor, 35 amps	
2130P-D395	2.9	11.0	300	20.7	2000	½ HP 12V DC Motor, 56C, 39 amps	
2130P-D399	4.0	15.1	200	13.8	2000	½ HP 12V DC Motor, 56C, 39 amps	
2130P-A055	2.4	9.1	300	20.7	1750	½ HP 115-208/230V AC Motor, 1 PH 50/60 Hz	
2130P-A079	3.9	14.8	300	20.7	1750	¾ HP 115-208/230V AC Motor, 1 PH 50/60 Hz	
2130PX	Replacement pump head						

## Performance

Model Number	0 PSI / 0 BAR		50 PSI / 3.5 BAR		100 PSI / 6.9 BAR		150 PSI / 10.3 BAR		200 PSI / 13.8 BAR		250 PSI / 17.2 BAR		300 PSI / 20.7 BAR	
	GPM	AMPS	GPM	AMPS	GPM	AMPS	GPM	AMPS	GPM	AMPS	GPM	AMPS	GPM	AMPS
	L / min		L / min		L / min		L / min		L / min		L / min		L / min	
2130P-D183 <sup>1</sup>	2.5	5.2	2.2	9.8	2.0	14.6 *	1.8	19.3 *	-	-	-	-	-	-
	9.5		8.3		7.6		6.8		-	-	-	-		
2130P-D355 <sup>1</sup>	2.8	9.1	2.5	13.4	2.4	18.9	2.3	23.5	2.2	27.5 *	2.1	30.9 *	2.0	34.8 *
	10.6		9.5		9.1		8.7		8.3		7.9		7.6	
2130P-D359 <sup>1</sup>	3.9	11.6	3.2	17.2	3.1	21.5 *	3.0	26.2 *	2.8	31.8 *	-	-	-	-
	14.8		12.1		11.7		11.4		10.6		-	-	-	
2130P-D395 <sup>1</sup>	2.9	8.3	2.5	13.0	2.4	19.0	2.3	23.5	2.2	27.2	2.1	30.7	2.0	33.9
	11.0		9.5		9.1		8.7		8.3		7.9		7.6	
2130P-D399 <sup>1</sup>	4.0	11.0	3.5	17.2	3.3	24.0	3.1	29.3	3.0	34.2	-	-	-	-
	15.1		13.2		12.5		11.7		11.4		-	-	-	
2130P-A055 <sup>2</sup>	2.4	6.5	2.2	6.6	2.1	6.7	2.1	6.8	2.0	7.0	1.9	7.2	1.9	7.3
	9.1		8.3		7.9		7.9		7.6		7.2		7.2	
2130P-A079 <sup>2</sup>	3.9	8.9	3.4	9.0	3.3	9.1	3.2	9.5	3.1	9.8	3.0	10.1	2.9	10.6
	14.8		12.9		12.5		12.1		11.7		11.4		11.0	

\* indicates intermittent duty only <sup>1</sup> Tested at 13.5 VDC <sup>2</sup> Tested at 110 VAC

# VERSA-TWIN 2130 Series Plunger Pumps with Pressure Switch

## THE INDUSTRY-FIRST INTEGRATED AUTOMATIC-DEMAND PRESSURE SWITCH

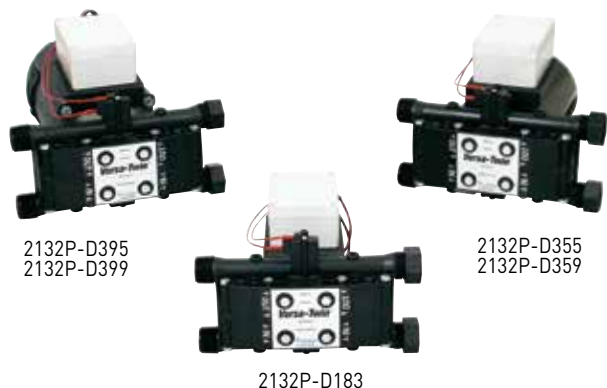

- Integrated pressure switch designed for the pump to work as a demand pump
- Extends the life of the pump when the duty cycle is less than 100%, for example, a 50% duty cycle extends the life of the system two times and a 25% duty cycle extends the life four times
- Reduces end-user installation charges by allowing a system to be set up for overnight charging versus continuous charging through a custom, high-amp vehicle alternator and heavy-gauge wiring system

### Order Information

Model Number	Max GPM	Max L/min	Max PSI	Max BAR	Max RPM	Motor Type	Pressure Switch	Ports
2132P-D183	2.5	9.5	150	10.3	2200	1/4 HP 12V DC Motor, 20 amps	150-250 PSI (10.3-17.2 BAR)	1" MNPT
2132P-D355	2.8	10.6	250	17.2	2000	1/2 HP 12V DC Motor, 35 amps	150-250 PSI (10.3-17.2 BAR)	
2132P-D359	3.9	14.8	200	13.8	2000	1/2 HP 12V DC Motor, 35 amps	150-250 PSI (10.3-17.2 BAR)	
2132P-D395	2.9	11.0	250	17.2	2000	1/2 HP 12V DC Motor, 39 amps	150-250 PSI (10.3-17.2 BAR)	
2132P-D399	4.0	15.1	200	13.8	2000	1/2 HP 12V DC Motor, 39 amps	150-250 PSI (10.3-17.2 BAR)	
2133P-D355	2.8	10.6	300	20.7	2000	1/2 HP 12V DC Motor, 35 amps	250-350 PSI (17.2-24.1 BAR)	
2133P-D395	2.9	11.0	300	20.7	2000	1/2 HP 12V DC Motor, 56C, 39 amps	250-350 PSI (17.2-24.1 BAR)	
2132PX	Replacement pump head & switch						150-250 PSI (10.3-17.2 BAR)	
2133PX	Replacement pump head & switch						250-350 PSI (17.2-24.1 BAR)	

### Performance

Model Number	0 PSI / 0 BAR		50 PSI / 3.5 BAR		100 PSI / 6.9 BAR		150 PSI / 10.3 BAR		200 PSI / 13.8 BAR		250 PSI / 17.2 BAR		300 PSI / 20.7 BAR	
	GPM	AMPS	GPM	AMPS	GPM	AMPS	GPM	AMPS	GPM	AMPS	GPM	AMPS	GPM	AMPS
	L / min		L / min		L / min		L / min		L / min		L / min		L / min	
2132P-D183 <sup>1</sup>	2.5	5.2	2.2	9.8	2.0	14.6 *	1.8	19.3 *	-	-	-	-	-	-
	9.5		8.3		7.6		6.8		-		-			
2132P-D355 <sup>1</sup> 2133P-D355 <sup>1</sup>	2.8	9.1	2.5	13.4	2.4	18.9	2.3	23.5	2.2	27.5 *	2.1	30.9 *	2.0	34.8 *
	10.6		9.5		9.1		8.7		8.3		7.9		7.6	
2132P-D359 <sup>1</sup>	3.9	11.6	3.2	17.2	3.1	21.5	3.0	26.2 *	2.8	31.8 *	-	-	-	-
	14.8		12.1		11.7		11.4		10.6		-			
2132P-D395 <sup>1</sup> 2133P-D395 <sup>1</sup>	2.9	8.3	2.5	13.0	2.4	19.0	2.3	23.5	2.2	27.2	2.1	30.7	2.0	33.9
	11.0		9.5		9.1		8.7		8.3		7.9		7.6	
2132P-D399 <sup>1</sup>	4.0	11.0	3.5	17.2	3.3	24.0	3.1	29.3	3.0	34.2	-	-	-	-
	15.1		13.2		12.5		11.7		11.4		-			

\* indicates intermittent duty only <sup>1</sup> Tested at 13.5 VDC <sup>2</sup> Tested at 110 VAC

# VERSA-TWIN 2150 Series Diaphragm Pumps



## Order Information

Model Number	Max GPM	Max LPM	Max PSI	Max BAR	Max RPM	Motor Type	Ports
2150P-D35DC	7	26.5	100	6.9	1800	1/2 HP 12V DC Motor, 35 amps	3/4" MNPT
2150P-D39DC	8.3	31.4	100	6.9	1800	1/2 HP 12V DC Motor, 56C, 39 amps	
2150P-D05AC	6.7	25.4	100	6.9	1750	1/2 HP 115-208/230 VAC Motor, 1 PH, 50/60 Hz	
2150PX						Replacement pump head	
3430-0633						Diaphragm repair kit	
3430-0634						Diaphragm valve kit	

Model	GPM		AMPS		GPM		AMPS		GPM		AMPS		GPM		AMPS	
	LPM	AMPS	LPM	AMPS	LPM	AMPS	LPM	AMPS	LPM	AMPS	LPM	AMPS	LPM	AMPS	LPM	AMPS
	0 PSI/0 BAR		20 PSI/1.4 BAR		40 PSI/2.8 BAR		60 PSI/4.1 BAR		80 PSI/5.5 BAR		100 PSI/6.9 BAR					
2150P-D35DC <sup>1</sup>	7.0	12.9	6.6	17.2	6.0	22.3	5.6	26.8*	5.2	31.2*	5.0	35.3*				
	26.5		25.0		22.7		21.2		19.7		18.9					
2150P-D39DC <sup>1</sup>	8.3	15.7	7.6	19.7	6.7	23.8	6.1	27.8	5.7	31.9	5.3	35.9				
	31.4		28.8		25.4		23.1		21.6		20.1					
2150P-D05AC <sup>2</sup>	6.7	7.6	6.4	7.7	6.0	7.8	5.7	7.9	5.3	8.0	5.0	8.2				
	25.4		24.2		22.7		21.6		20.1		18.9					

\* Indicates intermittent duty only <sup>1</sup> Tested at 13.5 VDC <sup>2</sup> Tested at 110 VAC

## Versa-Twin Accessories



### Hosebarb Fly Nut Fittings

O-ring Groove x Hose Barb	Fitting Part Number	Fly nut Part Number	O-ring Part Number
1" x 1" straight	FNS-100100	3B100	1721-0010
1" x 3/4" straight	FNS-10034		
1" x 1/2" straight	FNS-10012		
1" x 1" elbow	FNE-100100		
1" x 3/4" elbow	FNE-10034		



### NPT Fly Nut Fittings

Fly Nut connection X NPT			
O-ring Groove x NPT	Fitting Part Number	Fly nut Part Number	O-ring Part Number
1" x 3/4" MNPT *	2404-0427	3B100	1721-0010
1" x 1/2" MNPT	2404-0419		

\* Compatible with other fly-nut fittings in catalog

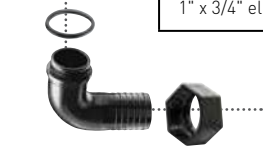

### Fly Nut Cap

Description	Part Number
1" NPT with gasket	FNCAP-100N
Replacement gasket	01WSHR13



### Unloader Valve

Part Number	Operating PSI	Operating BAR	Use With	Material
3390-0062D	200-600	13.8-41.4	35 & 39 amp DC, and all AC motors	Brass, Buna-N Cup



### Pulse Hose

Part Number	Max PSI	Max BAR	Description
3375-0025*	1500	183.4	9 ft Pulse Hose, 3/8" (M)NPT w/ one plugged end

\*Used with all pressure switch models when using rigid pipe, rigid or semi-rigid hose (working pressure greater than 600 psi) or any hose less than 150 ft.



### Relief Valve

Part Number	Operating PSI	Operating BAR	Material	Ports (Inlet x Outlet)	Use With
3300-0001	400	27.6	Bronze	3/4" MNPT x 3/4" FNPT	35 & 39 amp DC, and all AC motors
3300-0002	200	13.8	Bronze	1/2" MNPT x 1/2" FNPT	18 amp DC motors
3300-0015	150	10.3	Nylon	3/4" MNPT x 3/4" FNPT	18 amp DC motors
3300-0016	250	17.2	Nylon	3/4" MNPT x 3/4" FNPT	35 & 39 amp DC, and all AC motors
3300-0098	400	27.6	Nylon	3/4" MNPT x 3/4" FNPT	18 amp DC motors
3301-0001	400	27.6	Bronze	3/4" MNPT x 3/4" FNPT	35 & 39 amp DC, and all AC motors

# Electric-Driven Centrifugal Pumps – Noryl®

Model 9940-9750NRL, 9940-9751NRL, 9940-9753NRL



## Model 9940-9750NRL

- Noryl, pedestal mount, direct drive
- Port sizes: 1-1/2" NPT inlet  
1-1/2" NPT outlet
- Max. fluid temperature: 140°F/60°C
- Housing: Noryl (chemical-resistant, coated, cast iron bearing housing)
- Impeller: Noryl
- Pump shaft rotation: CW\*
- Shaft seals: Viton®/ceramic with polypropylene case
- Weight: 12 lbs./5.4 kg

## Model 9940-9751NRL

- Noryl, close-coupled, AC motor-driven (60 Hz), centrifugal pump
- Port sizes: 1-1/2" NPT inlet  
1-1/2" NPT outlet
- Max. fluid temperature: 140°F/60°C
- Housing: Noryl
- Impeller: Noryl
- Motor: 3/4 hp, 115 / 208-230V AC
- Shaft seals: Viton®/ceramic with polypropylene case
- Weight: 34 lbs./15.4 kg

## Model 9940-9753NRL

- Noryl, close-coupled, AC motor-driven (60 Hz), centrifugal pump
- Port sizes: 1-1/2" NPT inlet,  
1-1/2" NPT outlet
- Max. fluid temperature: 140°F/60°C
- Housing: Noryl
- Impeller: Noryl
- Motor: 1-1/2 hp, 115 / 208-230V AC
- Shaft seals: Viton®/ceramic with polypropylene case
- Weight: 39 lbs./17.7 kg

## Order Information

Model Number	Max GPM	Max LPM	Max PSI	Max BAR	Max RPM
9940-9750NRL	140	530	39	2.7	3600
9940-9751NRL	47	178	30	2.1	3450
9940-9753NRL	91	344	35	2.4	3450

## 9940-9750NRL

## U.S. Units

RPM	10 PSI		15 PSI		20 PSI		25 PSI		30 PSI		35 PSI	
	GPM	HP	GPM	HP	GPM	HP	GPM	HP	GPM	HP	GPM	HP
3000	103	1.5	90	1.4	72	1.4	38	1.0				
3450	126	2.4	114	2.4	101	2.2	86	2.2	64	1.9	14	1.4
3600	132	2.7	121	2.6	110	2.5	97	2.5	80	2.3	52	2.0

## 9940-9750NRL

## Metric Units

RPM	0.7 BAR		1.0 BAR		1.4 BAR		1.7 BAR		2.1 BAR		2.4 BAR	
	LPM	HP	LPM	HP	LPM	HP	LPM	HP	LPM	HP	LPM	HP
3000	390	1.5	341	1.4	273	1.4	144	1.0				
3450	477	2.4	432	2.4	382	2.2	326	2.2	242	1.9	53	1.4
3600	500	2.7	458	2.6	416	2.5	367	2.5	303	2.3	197	2.0

## 9940-9751NRL, 9940-9753NRL

## U.S. Units

MODEL	5 PSI		10 PSI		15 PSI		20 PSI		25 PSI		30 PSI	
	GPM	AMPS	GPM	AMPS	GPM	AMPS	GPM	AMPS	GPM	AMPS	GPM	AMPS
9751	44	7.9	39	8.0	32	8.3	25	8.5	15	8.5	2	8.4
9753	88	14.1	82	14.0	74	14.0	66	14.4	55	14.4	37	13.6

## 9940-9751NRL, 9940-9753NRL

## Metric Units

MODEL	0.3 BAR		0.7 BAR		1.0 BAR		1.4 BAR		1.7 BAR		2.1 BAR	
	LPM	AMPS	LPM	AMPS	LPM	AMPS	LPM	AMPS	LPM	AMPS	LPM	AMPS
9751	167	7.9	148	8.0	121	8.3	95	8.5	57	8.5	8	8.4
9753	333	14.1	310	14.0	280	14.0	250	14.4	208	14.4	140	13.6

# Hydraulic-Driven Gear Pump

## Model 8304B-HM5C



This positive-displacement pump is ideal for de-icing/anti-icing (pre-wet). Combining the pump and motor as a single unit eliminates the need for shaft alignment or Love-Joy® coupling. The unit's compact size allows it to be used in a wide variety of locations and makes it especially attractive for quick, easy retrofit installations.

### Pump

- Optional pressure relief valve safeguards against pressure buildup
- Industry-proven gear pump design, minimal moving parts for longevity
- Brass material not corroded by salt solutions

### Motor

- State-of-the-art internal gear gerotor motor maximum service for any application
- Bypass adjustment allows fine tuning of flow control
- 1/2" NPT ports with anti-reverse check safeguards against change in flow direction

### Order Information

Model Number	Max GPM	Max LPM	Max PSI	Max BAR	Max Hyd GPM	Max Hyd LPM
8304B-HM5C	10.4	39.4	100	6.9	4.5	17
8304B	10.4	39.4	100	6.9	4.5	17
8304BV	10.4	39.4	100	6.9	4.5	17

Hydraulic Flow (GPM)	GPM at 0 PSI	GPM at 10 PSI	GPM at 20 PSI	GPM at 30 PSI	GPM at 40 PSI	GPM at 50 PSI	GPM at 60 PSI	GPM at 70 PSI	GPM at 80 PSI	GPM at 90 PSI	GPM at 100 PSI
3.0	6.9	6.5	6.1	5.7	5.3	4.9	4.5	4.1	3.7	3.3	2.9
3.5	8.1	7.7	7.3	6.9	6.6	6.2	5.8	5.4	5.0	4.6	4.2
4.0	9.2	8.9	8.5	8.1	7.8	7.4	7.0	6.7	6.2	5.9	5.5
4.5	10.4	10.1	9.7	9.3	9.0	8.6	8.2	7.9	7.5	7.1	6.8

This data was generated using water as the pumping media. Performance will vary with different viscosity fluids.

Hydraulic pressures vary from 200 to 850 PSI for the performance chart above.

\* Product is to be run above 2.0 GPM hydraulic flow.

# Aqua-Tiger - 12-Volt Centrifugal Pump

## Model 9700B and 9700S



- 12-volt DC motor drive
- Port sizes: 3/4" NPT inlet, 3/4" NPT outlet
- Max. fluid temperature: 140°F/60°C
- Housing: bronze or stainless steel
- Impeller: bronze (9700B) or stainless steel (9700S)
- Seal: lip-type Viton (9700B); mechanical (9700S)
- Weight: 6 lbs./2.7 kg

### Order Information

Model Number	Max GPM	Max LPM	Max PSI	Max BAR	Max Draw
9700B	19	72	7	0.48	11 Amps
9700S	19	72	7	0.48	11 Amps

### 9700B, 9700S - 13.5 VDC (Alternator Engine Running)

### U.S. Units

2 PSI		3 PSI		4 PSI		5 PSI		6 PSI		7 PSI	
GPM	AMPS	GPM	AMPS	GPM	AMPS	GPM	AMPS	GPM	AMPS	GPM	AMPS
16.9	5.3	14.0	5.0	12.5	4.9	10	4.9	6.5	4.1	2.7	3.7

### 9700B, 9700S - 13.5 VDC (Alternator Engine Running)

### Metric Units

0.14 BAR		0.21 BAR		0.28 BAR		0.34 BAR		0.41 BAR		0.48 BAR	
LPM	AMPS	LPM	AMPS	LPM	AMPS	LPM	AMPS	LPM	AMPS	LPM	AMPS
62	5.3	53	5.0	47	4.9	38	4.9	25	4.1	10	3.7



# Pump Cutaways

## Hypro Cutaway Policy

Due to the increase in demand of Hypro cutaways for effective sales promotions, Hypro is offering pump cutaways on a purchase or loan basis. To purchase a cutaway, follow the normal procedure for ordering a pump.

If you would like to borrow a cutaway, order your cutaway and then return it to Hypro (with Return Materials Authorization – RMA – number) before 60 days from your date of receipt. When Hypro receives the cutaway, full credit will be issued.

If you would like a pump or accessory that is not listed on this page, please call the Hypro factory at 800-424-9776 (US) or +44 1954 260097 (Europe)

## Roller Pump Cutaways



Model Number	Description	Estimated Weight Ea.	
		US Units	Metric Units
CA6500C	Standard 6-roller cast iron pump	8 lbs.	3.6 kg
CA6500N	Standard 6-roller Ni-resist pump	8 lbs.	3.6 kg
CA6500XL	Standard 6-roller Silver Series XL pump	8 lbs.	3.6 kg
CA7560C	Standard 8-roller cast iron pump	13 lbs.	5.9 kg
CA7560N	Standard 8-roller Ni-resist pump	13 lbs.	5.9 kg
CA7560XL	Standard 8-roller Silver Series XL pump	13 lbs.	5.9 kg

## Centrifugal Pump Cutaways



Model Number	Description	Estimated Weight Ea.	
		US Units	Metric Units
CA9006C-O	Standard 540 rpm gear drive cast iron pump	44 lbs.	20.0 kg
CA9006P-O	Standard gear drive polypropylene pump	37 lbs.	16.8 kg
CA9202C	Standard pedestal mount cast iron pump	18 lbs.	8.2 kg
CA9203P-S	Standard pedestal mount polypropylene pump	14 lbs.	6.4 kg
CA9303C-HM4C	Standard hydraulic motor cast iron pump	22 lbs.	10.0 kg
CA9303P-HM4C	Standard hydraulic motor polypropylene pump	15 lbs.	6.8 kg

## Diaphragm Pump Cutaways



Model Number	Description	Estimated Weight Ea.	
		US Units	Metric Units
CA9910-D30	Standard 2 diaphragm pump	23 lbs.	10.4 kg
CA9910-D30GRGI	Standard 2 diaphragm pump with GS40GI control unit	33 lbs.	15.0 kg
CA9910-D70	Standard 2 diaphragm pump	25 lbs.	11.3 kg
CA9910-D115	Standard 3 diaphragm pump	35 lbs.	15.9 kg
CA9910-KIT1640	Gear Reduction Kit	6 lbs. 8oz.	2.9 kg

## Piston/Plunger Pump Cutaways



Model Number	Description	Estimated Weight Ea.	
		US Units	Metric Units
CA5210C	Standard 5200 series cast iron piston pump	18 lbs.	8.2 kg
CA5320C-HRX	Standard 5300 series cast iron piston pump	10 lbs.	4.5 kg
CA5321C-H	Standard 5321 series cast iron plunger pump	11 lbs.	5.0 kg
CA5324C	Standard 5324 series cast iron piston pump	11 lbs.	5.0 kg

# POWERPRO Gasoline Engines

High Quality, Field-Proven Engine



6.5 HP

2.5 HP

- Available in multiple horsepower options to suit a diverse range of agricultural, industrial, and lawn & garden applications
- Electric-start option available for quick start-up
- Dual-element air filter provides highest degree of filtering
- Cast iron cylinder sleeve for commercial use
- Overhead valve for cleaner operation on all models
- Equipped with a robust low-oil sensor to prevent engine damage
- CARB/EPA certified engines
- Engines can be configured to various Hypro pump models or purchased individually
- Supported with a one-year warranty from Hypro; repair parts available for easy servicing

13 HP Electric Start

## PowerPro Gasoline Engines, Recoil Start

CARB & EPA Part Number	EC Part Number	HP	Shaft Size
2549-0043	--	2.5	5/8" Keyed
2549-0042	--	2.5	1/2" with Flat
2541-0045	2541-0065	6.5	3/4" Keyed
2541-0046	--	6.5	5/8" Threaded
2541-0048	--	13	1" Keyed
2541-0050	--	13	1" Threaded

## PowerPro Gasoline Engines, Electric Start

CARB & EPA Part Number	HP	Shaft Size
2541-0053	6.5	3/4" Keyed
2541-0054*	6.5	2:1 reduced 3/4" Shaft
2541-0055	6.5	5/8" Threaded
2541-0049	13	1" Keyed
2541-0051	13	1" Threaded

\* Special order only, 100 pc. Minimum Order

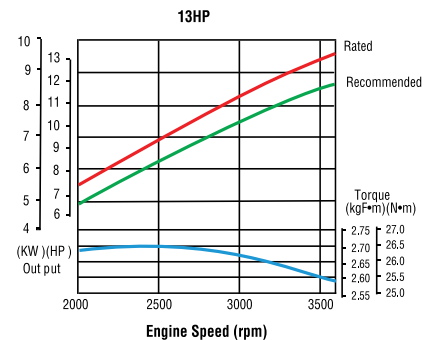
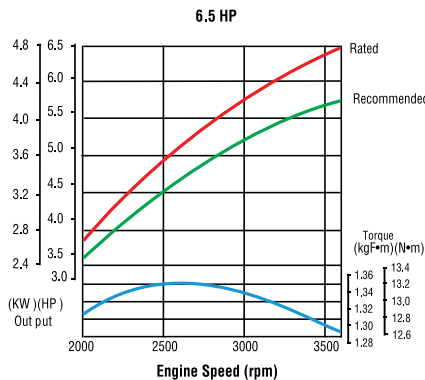
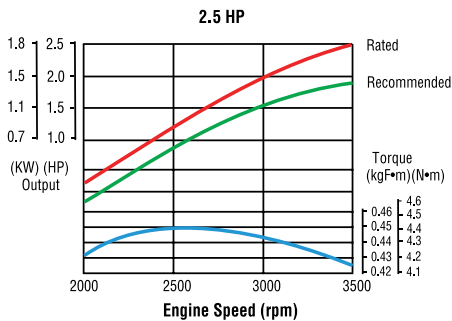

# Spray Nozzles

---

## **Broadcast Spray Nozzles ..... Page 134**

- Commonly used for herbicide, insecticide, and fungicides
  - Most effective with a tapered fan, designed for spray overlap, ensuring uniformity

## **Broadcast Wide-Angle Spray Nozzles..... Page 160**

- Commonly used with fertilizers and specialty applications
  - Wide spray pattern will overlap with adjacent patterns and improve uniformity

## **Streaming Spray Nozzles..... Page 166**

- Commonly used for fertilizer applications
  - Single streams are good for heavy crop residues and tilled fields.
  - Multiple streams are good for crops like wheat, where minimal plant burn is required

## **Banding & Directed Spray Nozzles ..... Page 172**

- Used for various applications including agricultural spraying and orchard/vineyard spraying
  - Even spray nozzles are designed to eliminate spray pattern overlap; used for spraying between crop rows or specific targeted areas

## **Specialty Spray Nozzles..... Page 188**

- Includes boomless nozzles, car wash/pressure cleaning nozzles, specialty crops, acid-resistant nozzles for harsh defoliant, misting nozzles, and more

# Selecting the Right Spray Nozzle



Visit [sprayit.hypropumps.com](http://sprayit.hypropumps.com) for Hypro's online nozzle calculator or download the FREE SprayIT app for Apple or Android devices.

Spray nozzles are often the smallest and most overlooked piece of equipment on a machine. However, they have the greatest effect on the accuracy and efficiency of each application. Hypro offers spray nozzles for a variety of pressure ranges, flow rates and spray patterns to fit any spray application.

To be effective, a pesticide must be applied properly. To select the correct spray nozzle for the job, first fully read the pesticide label and look for information on nozzle type, application rate, spray quality, and environmental restrictions. Then...

- 1) Check which type of spraying technique you will be using – broadcast or banding. (pg 130)
- 2) Check your sprayer speed. (pg 130)
- 3) Select the application rate from the pesticide label. (pg 130)
- 4) Determine the flow rate (GPM) needed for the spray nozzle, or use the application rate (GPA) chart for the desired nozzle. (pg 130)
- 5) Select the pattern type and nozzle technology. (pg 131)
- 6) Select nozzle size and pressure that provides the desired flow rate and application rate. (pg 131)
- 7) Check the spray quality tables to be sure the spray nozzle and pressure create the droplet spectrum you require. (pg 132)

## 1) Spraying Technique:

Broadcast spraying is when the entire field is to be treated. The width that each nozzle sprays, adjusted for spray overlap, is the distance between nozzles on the spray boom.

Band spraying is when planted rows or unplanted gaps are treated. The width that each nozzle sprays is the width of the treated band.

## 2) Sprayer Speed:

Forward speed of the spraying machine should be measured accurately. Radar or ultrasound speed sensors should be calibrated after installation or servicing. Wheel-driven speedometers should be calibrated whenever the driving surface changes, such as after cultivation. Speed can be determined if it is known how long it takes to drive a measured distance:

$$\text{speed in MPH} = \frac{\text{distance (feet)} \times 60}{\text{time (seconds)} \times 88}$$

or

$$\text{speed in Kmph} = \frac{\text{distance (m)} \times 3.6}{\text{time (seconds)}}$$

Improved vehicle design means that speeds up to 20 MPH are now possible. Higher speeds (10-20 MPH) improve work rates and timeliness; lower speeds (5-10 MPH) give improved canopy penetration and make spray drift control simpler.

## 3) Application Rate:

Read the pesticide label closely to determine an appropriate spray application rate. If a range of acceptable application rates is listed, choose a rate that best matches your situation.

## 4) Flow Rate:

Determine the exact flow required from each nozzle by calculating:

$$\text{GPM} = \frac{\text{GPA} \times \text{MPH} \times w}{5,940}$$

or

$$\text{LPM} = \frac{\text{L/ha} \times \text{Kmph} \times w}{600}$$

'W' changes depending on the type of applications:

- Nozzle spacing (in/m) for broadcast spraying
- Spray width (in/m) for single-nozzle band spraying or boomless spraying
- Row spacing (in/m) divided by the number of nozzles per row for directed spraying

Or you can read the application tables throughout this guide.

# Selecting the Right Spray Nozzle

## 5) Spray Pattern Type:

Flat Fan pattern – Available as a tapered spray for boom applications or an even spray for single nozzle applications. Even spray nozzles produce a narrow pattern, where spray is evenly deposited across the spray’s width. Tapered spray nozzles produce an elliptical spray pattern where more of the spray is deposited immediately under the nozzle. By overlapping tapered sprays, an even distribution across the entire boom can be obtained.



Deflect pattern – Also known as anvil or flood nozzles, deflect nozzles produce a wide-angled flat pattern when operated at low pressures (10-40 PSI/1-3 BAR), The nozzles generally produce a coarse, even spray.

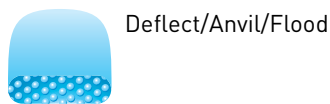

Cone pattern – These spray nozzles produce either a solid circular (full cone nozzles) or a hollow circular footprint (hollow cone nozzles). Full cones are ideal for spot spraying, whereas hollow cones are used on air-assisted sprayers and directed sprays.

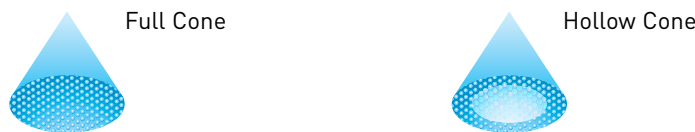

Other patterns – Specialty sprays call for specialty patterns, such as off-center or streaming sprays. An off-center pattern is used to extend spray patterns past the boom structure and streaming patterns are commonly used for fertilizer applications.



## Nozzle Technology:

### Standard Hydraulic (Total Range-TR)

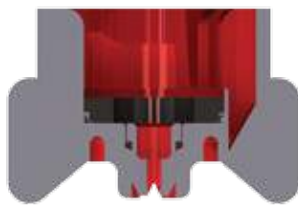

Flow Orifice  
& Pattern Creation

- Pro - Low Cost
- Con - Increased drift potential

### Pre-Orifice (Guardian-GRD)

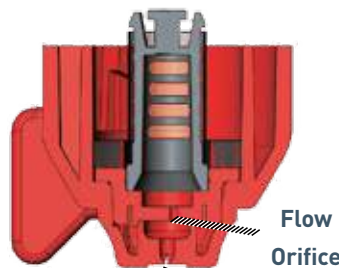

Pattern Creation

- Pro - Reduced drift potential
- Con - Multiple pieces to clean

### Air Induction (GuardianAIR Twin-GAT)

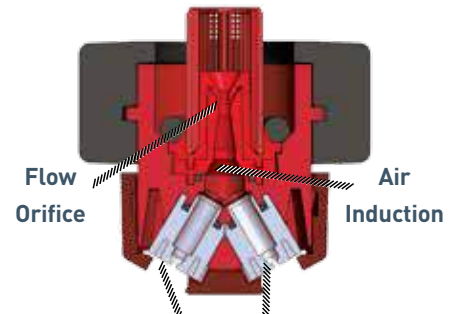

Pattern Creation

- Pro - Increased coverage and Reduced Drift
- Con - Reduced performance with thick suspension based solutions

## 6) Nozzle Size and Pressure:

Use the flow rate tables provided throughout this guide to select the nozzle and pressure that provides the flow needed for the application.

# Selecting the Right Spray Nozzle

## 7) Spray Quality:

The size and the variation of droplets determine the spray quality that a nozzle produces. To apply a spray solution safely and with the most agronomic value, it must be delivered with the appropriate droplet size spectrum.

### ASABE S572.1 Droplet Size Classification

The American Society of Agricultural and Biological Engineers (ASABE) developed the ASABE S572.1 standard to measure and interpret spray quality from nozzles.

Spray Quality*	Size of Droplets	VMD Range (Microns**)	Color Code	Retention on Difficult to Wet Leaves	Drift Potential
Extremely Fine	Small	<60	Purple	Excellent	High
Very Fine		61-105	Red	Excellent	
Fine		106-235	Orange	Very Good	
Medium		236-340	Yellow	Good	
Coarse		341-403	Blue	Moderate	
Very Coarse		404-502	Green	Poor	
Extremely Coarse	Large	503-665	White	Very Poor	Low
Ultra Coarse		>665	Black	Very Poor	

\*Always read the pesticide label to determine which spray quality is required.

\*\* Estimated from sample reference graph in ASABE/ANSI/ASAE Standard S572.1.

The ASABE S572.1 standard uses eight droplet classification categories, six of which are common for agriculture and horticulture: Very Fine, Fine, Medium, Coarse, Very Coarse and Extremely Coarse. Most agrochemical applications recommend a fine, medium, or coarse spray.

<b>Fine</b>	<p>sprays provide enhanced retention for directed spraying on the target including:</p> <ul style="list-style-type: none"> <li>• Foliar-acting weed control</li> <li>• Contact-acting fungicides and insecticides</li> </ul>	<b>Medium</b>	<p>sprays are the most widely used spray type.</p> <ul style="list-style-type: none"> <li>• Used by default by most applicators when spray quality is not defined by the label.</li> <li>• Systemic-acting fungicides, insecticides and herbicides.</li> </ul>	<b>Coarse</b>	<p>sprays are used with systemic, residual, and soil-applied herbicides.</p>
-------------	--	---------------	--	---------------	--

### BCPC Nozzle Classification

The British Crop Protection Council (BCPC) develop a standard for classifying nozzle droplet size. The standard is based on relative comparisons of droplet size using a set of agreed upon reference nozzles.

For conventional hydraulic nozzles, spray quality varies according to nozzle size (defined by nozzle flow in l/min) and with pressure, larger sizes and lower pressures produce larger droplets. Spray quality is defined by Volume Median Diameter (VMD) which is the mid-droplet size where half of the volume of spray is in larger and half in smaller droplets. The BCPC International Spray Classification System, groups nozzles into five categories: VERY FINE, FINE, MEDIUM, COARSE AND VERY COARSE, each category covering a range of VMDs.

Air Induction (AI) nozzles incorporate air as well as fluid in the droplets. As a result they are not classified by BCPC in the same way as standard hydraulic nozzles. AI nozzles tend to have a more uniform droplets size and less of the driftable fines. Those at the finer end of the spectrum can be successfully used in place of conventional 'medium' spray quality whilst at the same time reducing spray drift.

# Selecting the Right Spray Nozzle

The following chart has been designed to simplify selection of the correct spray nozzle type for the agrochemical to be applied. It is based on having good conditions for spraying and should be used in conjunction with the agrochemical manufacturer's label. Increased carrier rates may allow for coarser sprays to reduce risk of drift. Always follow the agrochemical label exactly.

Section	Code	Spray Nozzle	Common Use	Pattern	Technology	Orifice Material	Nominal Spray Angle	Pressure Range		ASABE Droplet Classification										
								PSI	BAR	XF	VF	F	M	C	VC	XC	UC			
Broadcast	ULD	Ultra Lo-Drift	Weeds	Tapered Flat Fan	Air Induction	Polyacetal	120°	20-115	1-8											
	GAT	GuardianAIR Twin	Plant Health	Tapered Flat Fan	Air Induction	Polyacetal	110°	30-115	2-8											
	ATW	Air Injected Twin Fan	Plant Health	Tapered Flat Fan	Air Induction	Ceramic	110°	40-100	3-7											
	GA	GuardianAIR	Plant Health	Tapered Flat Fan	Air Induction	Polyacetal	110°	20-115	1-8											
	AVI	Air Injected Anti-Drift	Weeds	Tapered Flat Fan	Air Induction	Ceramic	80°, 110°	30-100	2-7											
	GRD	Guardian	Plant Health	Tapered Flat Fan	Pre-Orifice	Polyacetal	120°	20-115	1-8											
	LD	Lo-Drift	Plant Health	Tapered Flat Fan	Pre-Orifice	Polyacetal	80°, 110°	20-70	1-5											
	ADI	Drift Reduction	Plant Health	Tapered Flat Fan	Air Induction	Ceramic	110°	30-70	2-5											
	VP	Variable Pressure	General	Tapered Flat Fan	Elliptical Orifice	Polyacetal	80°, 110°	20-70	1-5											
	TR	Total Range	General	Tapered Flat Fan	Elliptical Orifice	Stainless Steel	80°, 110°	20-70	1-5											
	AXI	Wide Range Fan	General	Tapered Flat Fan	Elliptical Orifice	Ceramic	80°, 110°	20-70	1-5											
	VPT	VP Tech	General	Tapered Flat Fan	Elliptical Orifice	Polyacetal	80°, 110°	20-70	1-5											
F	FanTip	General	Tapered Flat Fan	Elliptical Orifice	Polyacetal	80°, 110°	30-60	2-4												
Wide	HF	Hi-Flow	Fertilizer	Tapered Flat Fan	Pre-Orifice	Polyacetal	140°	20-80	1.5-6											
	DT	DeflecTip	Weeds & Fertilizer	Flood	Deflection	Polyacetal	80°-160°	10-60	1-4											
	APM	Wide Angle Flood	Weeds & Fertilizer	Flood	Deflection	Ceramic	80°-160°	10-60	1-4											
Stream	ESI	Six Stream	Fertilizer	Streams	Pre-Orifice	Ceramic or Polyacetal	110° Equivalent	15-60	1-4										S	
	CM	Fanjet 0°	Fertilizer	Stream	Round Orifice	PVDF	0°	15-60	1-4											S
	DC	Flow Regulating Disc	Fertilizer	Stream	Round Orifice	Polyacetal	0°	10-150	1-10											S
	AMT	Flow Regulating Disc	Fertilizer	Stream	Round Orifice	Ceramic	0°	10-725	1-50											S
Banding & Directed	DCC/CR	SwirlTip Disc/Core	Plant Health	Hollow Cone	Swirl	Polyacetal	25°-110°	10-150	1-10											
	DCC/CRC	Disc and Core	Plant Health	Hollow Cone	Swirl	Ceramic	13°-93°	10-300	1-20											
	HXC	HollowTip Hollow Cone	Plant Health	Hollow Cone	Swirl	Polyacetal	80°	40-150	3-10											
	ATR	Hollow Cone	Plant Health	Hollow Cone	Swirl	Ceramic	80°	40-350	3-24											
	TVI	Hollow Cone	Plant Health	Hollow Cone	Air Induction	Ceramic	80°	70-360	5-25											
	AVI	Air Injected Anti-Drift	Plant Health	Tapered Flat Fan	Air Induction	Ceramic	80°	40-350	3-24											
	AXI	Wide Range Fan	Plant Health	Tapered Flat Fan	Elliptical Orifice	Ceramic	80°	40-350	3-24											
	DCC/CRC	Disc and Core	Plant Health	Full Cone	Swirl	Ceramic	14°-71°	10-300	1-20											
	FCX	Full Cone	Plant Health	Full Cone	Swirl	Polyacetal	80°	15-150	1-10											
	E	FanTip Even Flat	Weeds	Even Flat Fan	Elliptical Orifice	Polyacetal	80°	30-60	2-4											
	OC	Off-Center Flat	Unspecialized	Off-Center Fan	Elliptical Orifice	Brass	80°	30-60	2-4											
	OCI	Off-Center Ceramic	Unspecialized	Off-Center Fan	Elliptical Orifice	Ceramic	80°	30-60	2-4											
AVI-OC	Air Injected Off-Center	Weeds	Off-Center Fan	Air Induction	Ceramic	80°	40-100	3-7												
Special	XT	Boom X Tender	Weeds	Boomless Fan	Pre-Orifice	Stainless or Polyacetal	105°	30-60	2-5											
	ACID LD	Lo-Drift	Acid Defoliant	Tapered Flat Fan	Pre-Orifice	PVDF	110°	30-60	2-4											
	TUR	Sudden Impact	Car Wash	0° Rotation	Turbo	Stainless or Brass	24° or 30°	800-3000	55-207											
	UAS	High Impact	Car Wash	Flat Fan	High Pressure	Ceramic	0°, 15°, 25°, 40°	800-5000	55-345											
	HP	High Pressure	Car Wash	Flat Fan	High Pressure	Hardened Stainless Steel	0°, 5°, 15°, 25°, 40°	300-4000	21-276											
	UAS/HP	Car Wash Nozzle Kits	Car Wash	Flat Fan	High Pressure	Ceramic or Hardened Stainless Steel	0°, 5°, 15°, 25°, 40°	300-5000	21-345											
	FP	FulcoJet	Car Wash	Full Cone	Swirl	PVDF	45°-80°	10-150	7-10											
	CM	FanJet	Car Wash	Flat Fan	Elliptical Orifice	PVDF	0°-110°	30-500	2-35											
	MISTING	F, HAF, PF, AFD, AF	Cooling & Humidification	Fan or Hollow Cone	Elliptical Orifice or Swirl	Polyacetal	65°-110°	40-150	3-10											
	E	Even	Knapsack	Even Flat Fan	Elliptical Orifice	Polyacetal	80°	15-45	1-3											
DT/AN	Deflect Nozzle/PoliJet	Knapsack	Flood	Deflection	Polyacetal	53°-127°	15-45	1-3												

S These nozzles produce streams to minimize atomization

## Understanding Droplet VMD

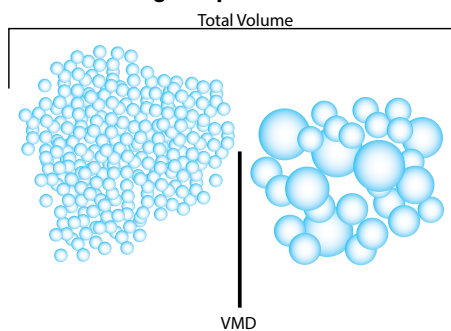

VMD is the droplet size at which 50% of the spray volume is in droplets larger than the VMD and 50% of the volume is in droplets smaller than the VMD (adapted from Matthews 1992).

## Understanding Micron Size

Degree of Atomization	Droplet Size (Microns)	Relative Size Related to Common Objects
Fog	Up to 25	Point of a Needle (25 Microns)
Fine Mist	20-100	Human Hair (100 Microns)
Fine Drizzle	100-250	Sewing Thread (150 Microns)
Heavy Drizzle	250-500	Toothbrush Bristle (300 Microns)
Light Rain	500-800	Staple (550 Microns)
Heavy Rain	800-1000	Paper Clip (850 Microns)
Thunderstorm Rain	1000-4000	#2 Pencil Lead (2000 Microns)

- Droplet sizes are usually expressed in microns (micrometers).
- One micron equals one thousandth of a millimeter.
- Lower spraying pressures provide larger droplet sizes, while higher spraying pressures yield smaller droplet sizes.
- The smallest droplet sizes are achieved by air atomizing nozzles.
- Generally speaking, the largest spray droplets are produced by wide-angle, flat hydraulic spray nozzles.



# Ultra Lo-Drift 120°



The ULD – Ultra Lo-Drift is the ideal spray nozzle for use where drift reduction is paramount. The nozzle produces large air-filled droplets, which cut drift dramatically compared with a standard fan and conventional low-drift spray nozzles. Ideal for use with pre-emergence and broad spectrum products.

- Creates air-filled droplets which significantly reduce spray drift
- Wide spray angle (120°) enables boom height to be lowered to further decrease drift
- Small, compact size reduces the chances of accidental breakage
- FastCap complete includes nozzle, cap, gasket and integrated strainers

## US Units

Nozzle Size	Droplet Size (PSI)	Flow Rate (GPM)	Gallons per Acre 20 inch nozzle spacing MPH										GAL/1000 Ft <sup>2</sup> 20 inch nozzle spacing				
			4	5	6	8	10	12	15	20	2	3	4	5			
015	UC	20	0.11	8.2	6.5	5.4	4.1	3.3	2.7	2.2	1.6	0.38	0.25	0.19	0.15		
	XC	30	0.13	9.7	7.7	6.4	4.8	3.9	3.2	2.6	1.9	0.44	0.30	0.22	0.18		
	VC	40	0.15	11.1	8.9	7.4	5.6	4.5	3.7	3.0	2.2	0.51	0.34	0.26	0.20		
	C	50	0.17	12.6	10.1	8.4	6.3	5.0	4.2	3.4	2.5	0.58	0.39	0.29	0.23		
	C	60	0.18	13.4	10.7	8.9	6.7	5.3	4.5	3.6	2.7	0.61	0.41	0.31	0.25		
	C	70	0.20	14.9	11.9	9.9	7.4	5.9	5.0	4.0	3.0	0.68	0.45	0.34	0.27		
	C	80	0.21	15.6	12.5	10.4	7.8	6.2	5.2	4.2	3.1	0.72	0.48	0.36	0.29		
	M	90	0.23	17.1	13.7	11.4	8.5	6.8	5.7	4.6	3.4	0.78	0.52	0.39	0.31		
	M	100	0.24	17.8	14.3	11.9	8.9	7.1	5.9	4.8	3.6	0.82	0.55	0.41	0.33		
	M	115	0.25	18.6	14.9	12.4	9.3	7.4	6.2	5.0	3.7	0.85	0.57	0.43	0.34		
02	UC	20	0.14	10.4	8.3	6.9	5.2	4.2	3.5	2.8	2.1	0.48	0.32	0.24	0.19		
	XC	30	0.17	12.6	10.1	8.4	6.3	5.0	4.2	3.4	2.5	0.58	0.39	0.29	0.23		
	C	40	0.20	14.9	11.9	9.9	7.4	5.9	5.0	4.0	3.0	0.68	0.45	0.34	0.27		
	C	50	0.22	16.3	13.1	10.9	8.2	6.5	5.4	4.4	3.3	0.75	0.50	0.38	0.30		
	C	60	0.24	17.8	14.3	11.9	8.9	7.1	5.9	4.8	3.6	0.82	0.55	0.41	0.33		
	C	70	0.26	19.3	15.4	12.9	9.7	7.7	6.4	5.1	3.9	0.89	0.59	0.44	0.35		
	M	80	0.28	20.8	16.6	13.9	10.4	8.3	6.9	5.5	4.2	0.95	0.64	0.48	0.38		
	M	90	0.30	22.3	17.8	14.9	11.1	8.9	7.4	5.9	4.5	1.02	0.68	0.51	0.41		
	M	100	0.32	23.8	19.0	15.8	11.9	9.5	7.9	6.3	4.8	1.09	0.73	0.55	0.44		
	M	115	0.34	25.2	20.2	16.8	12.6	10.1	8.4	6.7	5.0	1.16	0.77	0.58	0.46		
025	XC	20	0.18	13.4	10.7	8.9	6.7	5.3	4.5	3.6	2.7	0.61	0.41	0.31	0.25		
	XC	30	0.22	16.3	13.1	10.9	8.2	6.5	5.4	4.4	3.3	0.75	0.50	0.38	0.30		
	C	40	0.25	18.6	14.9	12.4	9.3	7.4	6.2	5.0	3.7	0.85	0.57	0.43	0.34		
	C	50	0.28	20.8	16.6	13.9	10.4	8.3	6.9	5.5	4.2	0.95	0.64	0.48	0.38		
	C	60	0.31	23.0	18.4	15.3	11.5	9.2	7.7	6.1	4.6	1.06	0.70	0.53	0.42		
	M	70	0.33	24.5	19.6	16.3	12.3	9.8	8.2	6.5	4.9	1.13	0.75	0.56	0.45		
	M	80	0.35	26.0	20.8	17.3	13.0	10.4	8.7	6.9	5.2	1.19	0.80	0.60	0.48		
	M	90	0.38	28.2	22.6	18.8	14.1	11.3	9.4	7.5	5.6	1.30	0.86	0.65	0.52		
	M	100	0.40	29.7	23.8	19.8	14.9	11.9	9.9	7.9	5.9	1.34	0.91	0.68	0.55		
	M	115	0.42	31.2	24.9	20.8	15.6	12.5	10.4	8.3	6.2	1.43	0.95	0.72	0.57		
03	XC	20	0.21	15.6	12.5	10.4	7.8	6.2	5.2	4.2	3.1	0.72	0.48	0.36	0.29		
	XC	30	0.26	19.3	15.4	12.9	9.7	7.7	6.4	5.1	3.9	0.89	0.59	0.44	0.35		
	C	40	0.30	22.3	17.8	14.9	11.1	8.9	7.4	5.9	4.5	1.02	0.68	0.51	0.41		
	C	50	0.34	25.2	20.2	16.8	12.6	10.1	8.4	6.7	5.0	1.16	0.77	0.58	0.46		
	C	60	0.37	27.5	22.0	18.3	13.7	11.0	9.2	7.3	5.5	1.26	0.84	0.63	0.50		
	M	70	0.40	29.7	23.8	19.8	14.9	11.9	9.9	7.9	5.9	1.36	0.91	0.68	0.55		
	M	80	0.42	31.2	24.9	20.8	15.6	12.5	10.4	8.3	6.2	1.43	0.95	0.72	0.57		
	M	90	0.45	33.4	26.7	22.3	16.7	13.4	11.1	8.9	6.7	1.53	1.02	0.77	0.61		
	M	100	0.47	34.9	27.9	23.3	17.4	14.0	11.6	9.3	7.0	1.60	1.07	0.80	0.64		
	M	115	0.51	37.9	30.3	25.2	18.9	15.1	12.6	10.1	7.6	1.74	1.16	0.87	0.70		
04	UC	20	0.28	20.8	16.6	13.9	10.4	8.3	6.9	5.5	4.2	0.95	0.64	0.48	0.38		
	UC	30	0.35	26.0	20.8	17.3	13.0	10.4	8.7	6.9	5.2	1.19	0.80	0.60	0.48		
	UC	40	0.40	29.7	23.8	19.8	14.9	11.9	9.9	7.9	5.9	1.34	0.91	0.68	0.55		
	XC	50	0.45	33.4	26.7	22.3	16.7	13.4	11.1	8.9	6.7	1.53	1.02	0.77	0.61		
	XC	60	0.49	36.4	29.1	24.3	18.2	14.6	12.1	9.7	7.3	1.67	1.11	0.84	0.67		
	XC	70	0.53	39.4	31.5	26.2	19.7	15.7	12.1	10.5	7.9	1.83	1.20	0.90	0.72		
	VC	80	0.57	42.3	33.9	28.2	21.2	16.9	14.1	11.3	8.5	1.94	1.30	0.97	0.78		
	VC	90	0.60	44.6	35.6	29.7	22.3	17.8	14.9	11.9	8.9	2.05	1.36	1.02	0.82		
	C	100	0.63	46.8	37.4	31.2	23.4	18.7	15.6	12.5	9.4	2.15	1.43	1.07	0.86		
	C	115	0.68	50.5	40.4	33.7	25.2	20.2	16.8	13.5	10.1	2.32	1.55	1.16	0.93		
05	UC	20	0.35	26.0	20.8	17.3	13.0	10.4	8.7	6.9	5.2	1.19	0.80	0.60	0.48		
	UC	30	0.43	31.9	25.5	21.3	16.0	12.8	10.6	8.5	6.4	1.47	0.98	0.73	0.59		
	XC	40	0.50	37.1	29.7	24.8	18.6	14.9	12.4	9.9	7.4	1.71	1.14	0.85	0.68		
	XC	50	0.56	41.6	33.3	27.7	20.8	16.6	13.9	11.1	8.3	1.91	1.27	0.95	0.76		
	VC	60	0.61	45.3	36.2	30.2	22.6	18.1	15.1	12.1	9.1	2.08	1.39	1.04	0.83		
	VC	70	0.66	49.0	39.2	32.7	24.5	19.6	16.3	13.1	9.8	2.25	1.50	1.13	0.90		
	VC	80	0.71	52.7	42.2	35.1	26.4	21.1	17.6	14.1	10.5	2.42	1.61	1.21	0.97		
	C	90	0.75	55.7	44.6	37.1	27.8	22.3	18.6	14.9	11.1	2.56	1.71	1.28	1.02		
	C	100	0.79	58.7	46.9	39.1	29.3	23.5	19.6	15.6	11.7	2.69	1.80	1.35	1.08		
	C	115	0.85	63.1	50.5	42.1	31.6	25.2	21.0	16.8	12.6	2.90	1.93	1.45	1.16		
06	UC	20	0.42	31.2	24.9	20.8	15.6	12.5	10.4	8.3	6.2	1.43	0.95	0.72	0.57		
	UC	30	0.52	38.6	30.9	25.7	19.3	15.4	12.9	10.3	7.7	1.77	1.18	0.89	0.71		
	XC	40	0.60	44.6	35.6	29.7	22.3	17.8	14.9	11.9	8.9	2.05	1.36	1.02	0.82		
	XC	50	0.67	49.7	39.8	33.2	24.9	19.9	16.6	13.3	9.9	2.28	1.52	1.14	0.91		
	VC	60	0.73	54.2	43.4	36.1	27.1	21.7	18.1	14.5	10.8	2.49	1.66	1.24	1.00		
	C	70	0.79	58.7	46.9	39.1	29.3	23.5	19.6	15.6	11.7	2.69	1.80	1.35	1.08		
	C	80	0.85	63.1	50.5	42.1	31.6	25.2	21.0	16.8	12.6	2.90	1.93	1.45	1.16		
	C	90	0.90	66.8	53.5	44.6	33.4	26.7	22.3	17.8	13.4	3.07	2.05	1.53	1.23		
	M	100	0.95	70.5	56.4	47.0	35.3	28.2	23.5	18.8	14.1	3.24	2.16	1.62	1.30		
	M	115	1.02	75.7	60.6	50.5	37.9	30.3	25.2	20.2	15.1	3.48	2.32	1.74	1.39		
08	UC	20	0.57	42.3	33.9	28.2	21.2	16.9	14.1	11.3	8.5	1.94	1.30	0.97	0.78		
	XC	30	0.69	51.2	41.0	34.2	25.6	20.5	17.1	13.7	10.2	2.35	1.57	1.18	0.94		
	VC	40	0.80	59.4	47.5	39.6	29.7	23.8	19.8	15.8	11.9	2.73	1.82	1.36	1.09		
	VC	50	0.89	66.1	52.9	44.1	33.0	26.4	22.0	17.6	13.2	3.03	2.02	1.52	1.21		
	C	60	0.98	72.8	58.2	48.5	36.4	29.1	24.3	19.4	14.6	3.34	2.23	1.67	1.34		
	C	70	1.06	78.7	63.0	52.5	39.4	31.5	26.2	21.0	15.7	3.61	2.41	1.81	1.45		
	C	80	1.13	83.9	67.1	55.9	42.0	33.6	28.0	22.4	16.8	3.85	2.57	1.93	1.54		
	M	90	1.20	89.1	71.3	59.4	44.6	35.6	29.7	23.8	17.8	4.09	2.73	2.05	1.64		





Maximum drift control in a 120° wide spray pattern for even coverage in broadcast applications



Unique 60° thick spray pattern for a wider coverage area. 120° wide by 60° thick pattern.



See [www.hypospraytips.com/certifications](http://www.hypospraytips.com/certifications) for the latest drift reduction standard information.

**Metric Units**

Nozzle Size	Droplet Size	Pressure (BAR)	Flow Rate (LPM)	Application Rate L/Ha - 50cm spacing KM/H						Drift Reduction Standards	
				7	8	10	12	15	20		25
015	UC	1	0.35	60	53	42	35	28	21	17	14
	UC	1.5	0.42	72	63	50	42	34	25	20	17
	XC	2	0.49	84	74	59	49	39	29	24	20
	C	3	0.60	103	90	72	60	48	36	29	24
	C	4	0.69	118	104	83	69	55	41	33	28
	C	5	0.77	132	116	92	77	62	46	37	31
	M	6	0.85	146	128	102	85	68	51	41	34
	M	7	0.92	158	138	110	92	74	55	44	37
M	8	0.98	168	147	118	98	78	59	47	39	
02	UC	1	0.46	79	69	55	46	37	28	22	18
	UC	1.5	0.57	98	86	68	57	46	34	27	23
	XC	2	0.65	111	98	78	65	52	39	31	26
	C	3	0.80	137	120	96	80	64	48	38	32
	C	4	0.92	158	138	110	92	74	55	44	37
	C	5	1.03	177	155	124	103	82	62	49	41
	M	6	1.13	194	170	136	113	90	68	54	45
	M	7	1.22	209	183	146	122	98	73	59	49
M	8	1.31	225	197	157	131	105	79	63	52	
025	UC	1	0.58	99	87	70	58	46	35	28	23
	UC	1.5	0.71	122	107	85	71	57	43	34	28
	XC	2	0.82	141	123	98	82	66	49	39	33
	C	3	1.00	171	150	120	100	80	60	48	40
	C	4	1.15	197	173	138	115	92	69	55	46
	C	5	1.29	221	194	155	129	103	77	62	52
	M	6	1.41	242	212	169	141	113	85	68	56
	M	7	1.53	262	230	184	153	122	92	73	61
M	8	1.63	279	245	196	163	130	98	78	65	
03	UC	1	0.69	118	104	83	69	55	41	33	28
	UC	1.5	0.85	146	128	102	85	68	51	41	34
	XC	2	0.98	168	147	118	98	78	59	47	39
	C	3	1.20	206	180	144	120	96	72	58	48
	C	4	1.39	238	209	167	139	111	83	67	56
	C	5	1.55	266	233	186	155	124	93	74	62
	M	6	1.70	291	255	204	170	136	102	82	68
	M	7	1.83	314	275	220	183	146	110	88	73
M	8	1.96	336	294	235	196	157	118	94	78	
04	UC	1	0.92	158	138	110	92	74	55	44	37
	UC	1.5	1.13	194	170	136	113	90	68	54	45
	UC	2	1.31	225	197	157	131	105	79	63	52
	XC	3	1.60	274	240	192	160	128	96	77	64
	XC	4	1.85	317	278	222	185	148	111	89	74
	XC	5	2.07	355	311	248	207	166	124	99	83
	VC	6	2.26	387	339	271	226	181	136	108	90
	VC	7	2.44	418	366	293	244	195	146	117	98
VC	8	2.61	447	392	313	261	209	157	125	104	
05	UC	1	1.15	197	173	138	115	92	69	55	46
	UC	1.5	1.41	242	212	169	141	113	85	68	56
	UC	2	1.63	279	245	196	163	130	98	78	65
	XC	3	2.00	343	300	240	200	160	120	96	80
	XC	4	2.31	396	347	277	231	185	139	111	92
	VC	5	2.58	442	387	310	258	206	155	124	103
	VC	6	2.83	485	425	340	283	226	170	136	113
	C	7	3.06	525	459	367	306	245	184	147	122
C	8	3.27	561	491	392	327	262	196	157	131	
06	UC	1	1.39	238	209	167	139	111	83	67	56
	UC	1.5	1.70	291	255	204	170	136	102	82	68
	UC	2	1.96	336	294	235	196	157	118	94	78
	XC	3	2.40	411	360	288	240	192	144	115	96
	C	4	2.77	475	416	332	277	222	166	133	111
	C	5	3.10	531	465	372	310	248	186	149	124
	C	6	3.39	581	509	407	339	271	203	163	136
	C	7	3.67	629	551	440	367	294	220	176	147
C	8	3.92	672	588	470	392	314	235	188	157	
08	UC	1	1.85	317	278	222	185	148	111	89	74
	UC	1.5	2.26	387	339	271	226	181	136	108	90
	UC	2	2.61	447	392	313	261	209	157	125	104
	VC	3	3.20	549	480	384	320	256	192	154	128
	C	4	3.70	634	555	444	370	296	222	178	148
	C	5	4.13	708	620	496	413	330	248	198	165
	M	6	4.53	777	680	544	453	362	272	217	181
	M	7	4.89	838	734	587	489	391	293	235	196
M	8	5.23	897	785	628	523	418	314	251	209	

Droplet size based on ASABE S572.1 standard

Features	
Common Use	Weeds
Pattern	Tapered Flat Fan
Technology	Air Induction
Material	Polyacetal
Spray Angle	120°
Pressure Range	20-115 PSI (1-8 BAR)
Configuration	Nozzles, FastCap Complete

Optimum Boom Height	
15" (35 cm) Spacing	13" (33 cm)
20" (50 cm) Spacing	18" (46 cm)

Part Numbers	
Nozzles 120°	FastCap 120°
ULD120-015	FC-ULD120-015*
ULD120-02	FC-ULD120-02*
ULD120-025	FC-ULD120-025*
ULD120-03	FC-ULD120-03*
ULD120-04	FC-ULD120-04*
ULD120-05	FC-ULD120-05*
ULD120-06	FC-ULD120-06*
ULD120-08	FC-ULD120-08*

Replacement Strainers	
TS01-100	100 mesh strainer
TS01-50	50 mesh strainer

Replacement FastCap Gasket
1700-0255

\* FastCap version contain nozzle filters

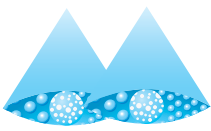

# GuardianAIR Twin 110°

GuardianAIR Twin spray nozzles are the best choice for high coverage applications where on-target spray delivery is important. They are ideal for low crops with complex canopies, such as vegetables, where thorough coverage of the target and protection of the surroundings are of high importance.



- High-coverage forward and rear facing fans help penetrate complex canopies
- Engineered to provide better coverage with more drops per gallon or litre compared to other air-induced sprays
- Easy-to-install, patent-pending locking ring and o-ring seal design
- FastCap complete includes nozzle, cap, gasket and is available with or without a filter

## US Units

Nozzle Size	Droplet Size	Pressure (PSI)	Flow Rate (GPM)	Gallons per Acre 20 inch nozzle spacing								GAL/1000F <sup>3</sup>			
				20 inch nozzle spacing								20 inch nozzle spacing			
				4	5	6	8	10	12	15	20	2	3	4	5
02	C	30	0.17	12.6	10.1	8.4	6.3	5.0	4.2	3.4	2.5	0.58	0.39	0.29	0.23
	M	40	0.20	14.9	11.9	9.9	7.4	5.9	5.0	4.0	3.0	0.68	0.45	0.34	0.27
	M	50	0.22	16.3	13.1	10.9	8.2	6.5	5.4	4.4	3.3	0.75	0.50	0.38	0.30
	M	60	0.24	17.8	14.3	11.9	8.9	7.1	5.9	4.8	3.6	0.82	0.55	0.41	0.33
	M	70	0.26	19.3	15.4	12.9	9.7	7.7	6.4	5.1	3.9	0.89	0.59	0.44	0.35
	M	80	0.28	20.8	16.6	13.9	10.4	8.3	6.9	5.5	4.2	0.95	0.64	0.48	0.38
M	90	0.30	22.3	17.8	14.9	11.1	8.9	7.4	5.9	4.5	1.02	0.68	0.51	0.41	
F	100	0.32	23.8	19.0	15.8	11.9	9.5	7.9	6.3	4.8	1.09	0.73	0.55	0.44	
F	115	0.34	25.2	20.2	16.8	12.6	10.1	8.4	6.7	5.0	1.16	0.77	0.58	0.46	
025	UC	30	0.22	16.3	13.1	10.9	8.2	6.5	5.4	4.4	3.3	0.75	0.50	0.38	0.30
	VC	40	0.25	18.6	14.9	12.4	9.3	7.4	6.2	5.0	3.7	0.85	0.57	0.43	0.34
	C	50	0.28	20.8	16.6	13.9	10.4	8.3	6.9	5.5	4.2	0.95	0.64	0.48	0.38
	M	60	0.31	23.0	18.4	15.3	11.5	9.2	7.7	6.1	4.6	1.06	0.70	0.53	0.42
	M	70	0.33	24.5	19.6	16.3	12.3	9.8	8.2	6.5	4.9	1.13	0.75	0.56	0.45
	M	80	0.35	26.0	20.8	17.3	13.0	10.4	8.7	6.9	5.2	1.19	0.80	0.60	0.48
M	90	0.38	28.2	22.6	18.8	14.1	11.3	9.4	7.5	5.6	1.30	0.86	0.65	0.52	
M	100	0.40	29.7	23.8	19.8	14.9	11.9	9.9	7.9	5.9	1.36	0.91	0.68	0.55	
M	115	0.42	31.2	24.9	20.8	15.6	12.5	10.4	8.3	6.2	1.43	0.95	0.72	0.57	
03	VC	30	0.26	19.3	15.4	12.9	9.7	7.7	6.4	5.1	3.9	0.89	0.59	0.44	0.35
	C	40	0.30	22.3	17.8	14.9	11.1	8.9	7.4	5.9	4.5	1.02	0.68	0.51	0.41
	M	50	0.34	25.2	20.2	16.8	12.6	10.1	8.4	6.7	5.0	1.16	0.77	0.58	0.46
	M	60	0.37	27.5	22.0	18.3	13.7	11.0	9.2	7.3	5.5	1.26	0.84	0.63	0.50
	M	70	0.40	29.7	23.8	19.8	14.9	11.9	9.9	7.9	5.9	1.36	0.91	0.68	0.55
	M	80	0.42	31.2	24.9	20.8	15.6	12.5	10.4	8.3	6.2	1.43	0.95	0.72	0.57
M	90	0.45	33.4	26.7	22.3	16.7	13.4	11.1	8.9	6.7	1.53	1.02	0.77	0.61	
M	100	0.47	34.9	27.9	23.3	17.4	14.0	11.6	9.3	7.0	1.60	1.07	0.80	0.64	
M	115	0.51	37.9	30.3	25.2	18.9	15.1	12.6	10.1	7.6	1.74	1.16	0.87	0.70	
035	XC	30	0.30	22.3	17.8	14.9	11.1	8.9	7.4	5.9	4.5	1.02	0.68	0.51	0.41
	C	40	0.35	26.0	20.8	17.3	13.0	10.4	8.7	6.9	5.2	1.19	0.80	0.60	0.48
	C	50	0.39	29.0	23.2	19.3	14.5	11.6	9.7	7.7	5.8	1.33	0.89	0.66	0.53
	M	60	0.43	31.9	25.5	21.3	16.0	12.8	10.6	8.5	6.4	1.47	0.98	0.73	0.59
	M	70	0.46	34.2	27.3	22.8	17.1	13.7	11.4	9.1	6.8	1.57	1.05	0.78	0.63
	M	80	0.49	36.4	29.1	24.3	18.2	14.6	12.1	9.7	7.3	1.67	1.11	0.84	0.67
M	90	0.53	39.4	31.5	26.2	19.7	15.7	13.1	10.5	7.9	1.81	1.20	0.90	0.72	
M	100	0.55	40.8	32.7	27.2	20.4	16.3	13.6	10.9	8.2	1.88	1.25	0.94	0.75	
M	115	0.59	43.8	35.0	29.2	21.9	17.5	14.6	11.7	8.8	2.01	1.34	1.01	0.80	
04	VC	30	0.35	26.0	20.8	17.3	13.0	10.4	8.7	6.9	5.2	1.19	0.80	0.60	0.48
	C	40	0.40	29.7	23.8	19.8	14.9	11.9	9.9	7.9	5.9	1.36	0.91	0.68	0.55
	C	50	0.45	33.4	26.7	22.3	16.7	13.4	11.1	8.9	6.7	1.53	1.02	0.77	0.61
	M	60	0.49	36.4	29.1	24.3	18.2	14.6	12.1	9.7	7.3	1.67	1.11	0.84	0.67
	M	70	0.53	39.4	31.5	26.2	19.7	15.7	13.1	10.5	7.9	1.81	1.20	0.90	0.72
	M	80	0.57	42.3	33.9	28.2	21.2	16.9	14.1	11.3	8.5	1.94	1.30	0.97	0.78
M	90	0.60	44.6	35.6	29.7	22.3	17.8	14.9	11.9	8.9	2.05	1.36	1.02	0.82	
M	100	0.63	46.8	37.4	31.2	23.4	18.7	15.6	12.5	9.4	2.15	1.43	1.07	0.86	
M	115	0.68	50.5	40.4	33.7	25.2	20.2	16.8	13.5	10.1	2.32	1.55	1.16	0.93	
05	VC	30	0.43	31.9	25.5	21.3	16.0	12.8	10.6	8.5	6.4	1.47	0.98	0.73	0.59
	C	40	0.50	37.1	29.7	24.8	18.6	14.9	12.4	9.9	7.4	1.71	1.14	0.85	0.68
	C	50	0.56	41.6	33.3	27.7	20.8	16.6	13.9	11.1	8.3	1.91	1.27	0.95	0.76
	M	60	0.61	45.3	36.2	30.2	22.6	18.1	15.1	12.1	9.1	2.08	1.39	1.04	0.83
	M	70	0.66	49.0	39.2	32.7	24.5	19.6	16.3	13.1	9.8	2.25	1.50	1.13	0.90
	M	80	0.71	52.7	42.2	35.1	26.4	21.1	17.6	14.1	10.5	2.42	1.61	1.21	0.97
M	90	0.75	55.7	44.6	37.1	27.8	22.3	18.6	14.9	11.1	2.56	1.71	1.28	1.02	
M	100	0.79	58.7	46.9	39.1	29.3	23.5	19.6	15.6	11.7	2.69	1.80	1.35	1.08	
M	115	0.85	63.1	50.5	42.1	31.6	25.2	21.0	16.8	12.6	2.90	1.93	1.45	1.16	
06	XC	30	0.52	38.6	30.9	25.7	19.3	15.4	12.9	10.3	7.7	1.77	1.18	0.89	0.71
	C	40	0.60	44.6	35.6	29.7	22.3	17.8	14.9	11.9	8.9	2.05	1.36	1.02	0.82
	C	50	0.67	49.7	39.8	33.2	24.9	19.9	16.6	13.3	9.9	2.28	1.52	1.14	0.91
	C	60	0.73	54.2	43.4	36.1	27.1	21.7	18.1	14.5	10.8	2.49	1.66	1.24	1.00
	M	70	0.79	58.7	46.9	39.1	29.3	23.5	19.6	15.6	11.7	2.69	1.80	1.35	1.08
	M	80	0.85	63.1	50.5	42.1	31.6	25.2	21.0	16.8	12.6	2.90	1.93	1.45	1.16
M	90	0.90	66.8	53.5	44.6	33.4	26.7	22.3	17.8	13.4	3.07	2.05	1.53	1.23	
M	100	0.95	70.5	56.4	47.0	35.3	28.2	23.5	18.8	14.1	3.24	2.16	1.62	1.30	
M	115	1.02	75.7	60.6	50.5	37.9	30.3	25.2	20.2	15.1	3.48	2.32	1.74	1.39	
08	VC	30	0.69	51.2	41.0	34.2	25.6	20.5	17.1	13.7	10.2	2.35	1.57	1.18	0.94
	C	40	0.80	59.4	47.5	39.6	29.7	23.8	19.8	15.8	11.9	2.73	1.82	1.36	1.09
	C	50	0.89	66.1	52.9	44.1	33.0	26.4	22.0	17.6	13.2	3.03	2.02	1.52	1.21
	C	60	0.98	72.8	58.2	48.5	36.4	29.1	24.3	19.4	14.6	3.34	2.23	1.67	1.34
	M	70	1.06	78.7	63.0	52.5	39.4	31.5	26.2	21.0	15.7	3.61	2.41	1.81	1.45
	M	80	1.13	83.9	67.1	55.9	42.0	33.6	28.0	22.4	16.8	3.85	2.57	1.93	1.54
M	90	1.20	89.1	71.3	59.4	44.6	35.6	29.7	23.8	17.8	4.09	2.73	2.05	1.64	
M	100	1.26	93.6	74.8	62.4	46.8	37.4	31.2	24.9	18.7	4.30	2.86	2.15	1.72	
M	115	1.36	101	80.8	67.3	50.5	40.4	33.7	26.9	20.2	4.64	3.09	2.32	1.86	

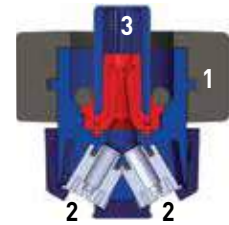

1. Integrated Locking Collar allows for precise and easy installation
2. Twin Air Induced spray patterns (30° offset) for superior coverage
3. Available with or without filter options



110° air inducted spray pattern for class leading coverage on a variety of targets.



Sturdy twin 30° incline/decline patterns provide superior canopy penetration through pattern integrity.



## Z.N.T.

See [www.hypospraytips.com/certifications](http://www.hypospraytips.com/certifications) for the latest drift reduction standard information.

### Metric Units

Nozzle Size	Droplet Size	Pressure (BAR)	Flow Rate (LPM)	Application Rate L/Ha - 50 cm Spacing							Drift Reduction Standards			
				7	8	10	12	15	20	25	30	LERAP	JKI	Z.N.T.
02	C	2	0,65	111	98	78	65	52	39	31	26	★★ 50-75% 2.0-2.25 BAR ★ 25-50% 2.25-2.5 BAR		66% 2.0-2.5 BAR
	M	3	0,80	137	120	96	80	64	48	38	32			
	M	4	0,92	158	138	110	92	74	55	44	37			
	M	5	1,03	177	155	124	103	82	62	49	41			
	M	6	1,13	194	170	136	113	90	68	54	45			
	F	7	1,22	209	183	146	122	98	73	59	49			
025	VC	2	0,82	141	123	98	82	66	49	39	33	★★ 50-75% 2.0-2.25 BAR ★ 25-50% 2.25-2.5BAR	50% 2.0-2.5 BAR Ref # G-1872	66% 2.0-2.5 BAR
	VC	3	1,00	171	150	120	100	80	60	48	40			
	M	4	1,15	197	173	138	115	92	69	55	46			
	M	5	1,29	221	194	155	129	103	77	62	52			
	M	6	1,41	242	212	169	141	113	85	68	56			
	M	7	1,53	262	230	184	153	122	92	73	61			
03	VC	2	0,98	168	147	118	98	78	59	47	39	★★ 50-75% 2.0-3.0 BAR ★ 25-50% 3.0-4.0 BAR	50% 2.0-3.0 BAR Ref # G-1874	66% 2.0-3.0 BAR
	C	3	1,20	206	180	144	120	96	72	58	48			
	M	4	1,39	238	209	167	139	111	83	67	56			
	M	5	1,55	266	233	186	155	124	93	74	62			
	M	6	1,70	291	255	204	170	136	102	82	68			
	M	7	1,83	314	275	220	183	146	110	88	73			
035	XC	2	1,14	195	171	137	114	91	68	55	46	★★ 50-75% 2.0-2.5 BAR	75% 1.5-2.0 BAR 50% 2.1-3.0 BAR Ref # G-1988	
	C	3	1,40	240	210	168	140	112	84	67	56			
	M	4	1,62	278	243	194	162	130	97	78	65			
	M	5	1,81	310	272	217	181	145	109	87	72			
	M	6	1,98	339	297	238	198	158	119	95	79			
	M	7	2,14	367	321	257	214	171	128	103	86			
04	VC	2	1,31	225	197	157	131	105	79	63	52	★ 25-50% 2.0-3.0 BAR	50% 2.0-2.5 BAR Ref # G-1875	66% 2.0-3.0 BAR
	C	3	1,60	274	240	192	160	128	96	77	64			
	M	4	1,85	317	278	222	185	148	111	89	74			
	M	5	2,07	355	311	248	207	166	124	99	83			
	M	6	2,26	387	339	271	226	181	136	108	90			
	M	7	2,44	418	366	293	244	195	146	117	98			
05	VC	2	1,63	279	245	196	163	130	98	78	65	★★ 50-75% 2.0-3.0 BAR ★ 25-50% 3.0-3.5 BAR	50% 2.0-3.0 BAR Ref # G-1876	66% 2.0-3.0 BAR
	C	3	2,00	343	300	240	200	160	120	96	80			
	M	4	2,31	396	347	277	231	185	139	111	92			
	M	5	2,58	442	387	310	258	206	155	124	103			
	M	6	2,83	485	425	340	283	226	170	136	113			
	M	7	3,06	525	459	367	306	245	184	147	122			
06	XC	2	1,96	336	294	235	196	157	118	94	78	★★ 50-75% 2.0-3.0 BAR ★ 25-50% 3.0-3.5 BAR	50% 2.0-4.0 BAR Ref # G-1877	66% 2.0-3.0 BAR
	C	3	2,40	411	360	288	240	192	144	115	96			
	C	4	2,77	475	416	332	277	222	166	133	111			
	M	5	3,10	531	465	372	310	248	186	149	124			
	M	6	3,39	581	509	407	339	271	203	163	136			
	M	7	3,67	629	551	440	367	294	220	176	147			
08	VC	2	2,61	447	392	313	261	209	157	125	104	★★ 50-75% 2.0-3.0 BAR ★ 25-50% 3.0-4.0 BAR	50% 2.0-6.0 BAR Ref # G-1878	66% 2.0-3.0 BAR
	C	3	3,20	549	480	384	320	256	192	154	128			
	C	4	3,70	634	555	444	370	296	222	178	148			
	M	5	4,13	708	620	496	413	330	248	198	165			
	M	6	4,53	777	680	544	453	362	272	217	181			
	M	7	4,89	838	734	587	489	391	293	235	196			
	M	8	5,23	897	785	628	523	418	314	251	209			

Droplet size based on ASABE S572.1 standard.  
Use at 3 bar for optimum coverage.

Features	
Common Use	Plant Health
Pattern	Tapered Flat Fan
Technology	Air Induction
Material	Polycetal
Spray Angle	110°
Pressure Range	30-115 PSI (2-8 BAR)
Configuration	FastCap Complete
Optimum Boom Height	
15" [35 cm] Spacing	13" [33 cm]
20" [50 cm] Spacing	18" [46 cm]
Part Numbers	
FastCaps 110° with filter	FastCaps 110° without filter
GAT110-02	GAT110-02A
GAT110-025	GAT110-025A
GAT110-03	GAT110-03A
GAT110-035	GAT110-035A
GAT110-04	GAT110-04A
GAT110-05	GAT110-05A
GAT110-06	GAT110-06A
GAT110-08	GAT110-08A
Replacement Parts	
TS02-50	50 mesh strainer for all sizes
65-BS205	O-Ring
30Q3579A	Replaceable cage for non-filter versions



# Ceramic AVI Twin 110<sup>o</sup>



The Albuz<sup>®</sup> AVI Twin (ATW) brings drift control and coverage together. Using proven AVI technology, the AVI Twin draws air into the nozzle, mixing it with the spray to create a twin spray of drift resistant air-filled droplets. Drift is greatly reduced, spraying the canopy with dual trajectories to improve coverage.

- Coverage-enhancing twin patterns from a single nozzle
- Drift-reducing AVI venturi technology
- 60-degrees of separation between fans
- Pressures from 40 to 100 psi (3-7 bar)
- Wear-resistant Albuz ceramic orifices

## US Units

Nozzle Size	Droplet Size	Pressure (PSI)	Flow Rate (GPM)	Gallons per Acre 20 inch nozzle spacing								GAL/1000 <sup>ft</sup>			
				MPH								20 inch nozzle spacing			
				4	5	6	8	10	12	15	20	2	3	4	5
01	XC	40	0.10	7.4	5.9	5.0	3.7	3.0	2.5	2.0	1.5	0.34	0.23	0.17	0.14
	XC	50	0.11	8.2	6.5	5.4	4.1	3.3	2.7	2.2	1.6	0.38	0.25	0.19	0.15
	XC	60	0.12	8.9	7.1	5.9	4.5	3.6	3.0	2.4	1.8	0.41	0.27	0.20	0.16
	C	70	0.13	9.7	7.7	6.4	4.8	3.9	3.2	2.6	1.9	0.44	0.30	0.22	0.18
	C	80	0.14	10.4	8.3	6.9	5.2	4.2	3.5	2.8	2.1	0.48	0.32	0.24	0.19
	C	90	0.15	11.1	8.9	7.4	5.6	4.5	3.7	3.0	2.2	0.51	0.34	0.26	0.20
015	XC	40	0.15	11.1	8.9	7.4	5.6	4.5	3.7	3.0	2.2	0.51	0.34	0.26	0.20
	XC	50	0.17	12.6	10.1	8.4	6.3	5.0	4.2	3.4	2.5	0.58	0.39	0.29	0.23
	XC	60	0.18	13.4	10.7	8.9	6.7	5.3	4.5	3.6	2.7	0.61	0.41	0.31	0.25
	C	70	0.20	14.9	11.9	9.9	7.4	5.9	5.0	4.0	3.0	0.68	0.45	0.34	0.27
	C	80	0.21	15.6	12.5	10.4	7.8	6.2	5.2	4.2	3.1	0.72	0.48	0.36	0.29
	C	90	0.23	17.1	13.7	11.4	8.5	6.8	5.7	4.6	3.4	0.78	0.52	0.39	0.31
02	XC	40	0.20	14.9	11.9	9.9	7.4	5.9	5.0	4.0	3.0	0.68	0.45	0.34	0.27
	XC	50	0.22	16.3	13.1	10.9	8.2	6.5	5.4	4.4	3.3	0.75	0.50	0.38	0.30
	XC	60	0.24	17.8	14.3	11.9	8.9	7.1	5.9	4.8	3.6	0.82	0.55	0.41	0.33
	C	70	0.26	19.3	15.4	12.9	9.7	7.7	6.4	5.1	3.9	0.89	0.59	0.44	0.35
	C	80	0.28	20.8	16.6	13.9	10.4	8.3	6.9	5.5	4.2	0.95	0.64	0.48	0.38
	C	90	0.30	22.3	17.8	14.9	11.1	8.9	7.4	5.9	4.5	1.02	0.68	0.51	0.41
03	XC	40	0.30	22.3	17.8	14.9	11.1	8.9	7.4	5.9	4.5	1.02	0.68	0.51	0.41
	XC	50	0.34	25.2	20.2	16.8	12.6	10.1	8.4	6.7	5.0	1.16	0.77	0.58	0.46
	XC	60	0.37	27.5	22.0	18.3	13.7	11.0	9.2	7.3	5.5	1.26	0.84	0.63	0.50
	VC	70	0.40	29.7	23.8	19.8	14.9	11.9	9.9	7.9	5.9	1.36	0.91	0.68	0.55
	VC	80	0.42	31.2	24.9	20.8	15.6	12.5	10.4	8.3	6.2	1.43	0.95	0.72	0.57
	C	90	0.45	33.4	26.7	22.3	16.7	13.4	11.1	8.9	6.7	1.53	1.02	0.77	0.61
04	XC	40	0.40	29.7	23.8	19.8	14.9	11.9	9.9	7.9	5.9	1.36	0.91	0.68	0.55
	XC	50	0.45	33.4	26.7	22.3	16.7	13.4	11.1	8.9	6.7	1.53	1.02	0.77	0.61
	XC	60	0.49	36.4	29.1	24.3	18.2	14.6	12.1	9.7	7.3	1.67	1.11	0.84	0.67
	VC	70	0.53	39.4	31.5	26.2	19.7	15.7	13.1	10.5	7.9	1.81	1.20	0.90	0.72
	VC	80	0.57	42.3	33.9	28.2	21.2	16.9	14.1	11.3	8.5	1.94	1.30	0.97	0.78
	C	90	0.60	44.6	35.6	29.7	22.3	17.8	14.9	11.9	8.9	2.05	1.36	1.02	0.82
05	XC	40	0.50	37.1	29.7	24.8	18.6	14.9	12.4	9.9	7.4	1.71	1.14	0.85	0.68
	XC	50	0.56	41.6	33.3	27.7	20.8	16.6	13.9	11.1	8.3	1.91	1.27	0.95	0.76
	XC	60	0.61	45.3	36.2	30.2	22.6	18.1	15.1	12.1	9.1	2.08	1.39	1.04	0.83
	VC	70	0.66	49.0	39.2	32.7	24.5	19.6	16.3	13.1	9.8	2.25	1.50	1.13	0.90
	VC	80	0.71	52.7	42.2	35.1	26.4	21.1	17.6	14.1	10.5	2.42	1.61	1.21	0.97
	C	90	0.75	55.7	44.6	37.1	27.8	22.3	18.6	14.9	11.1	2.56	1.71	1.28	1.02
	C	100	0.79	58.7	46.9	39.1	29.3	23.5	19.6	15.6	11.7	2.69	1.80	1.35	1.08

Droplet size based on ASABE S572.1 standard.



**Metric Units**

Nozzle Size	Droplet Size 110°	Pressure (bar)	Flow (L/min)	Application Rate L/Ha- 50 cm Spacing KM/H										
				6	8	10	12	14	16	18	20	25	30	
01	XC	3	0.40	105	79	63	53	45	39	35	32	25	21	
	XC	4	0.46	121	91	73	61	52	45	40	36	29	24	
	C	5	0.52	137	103	82	68	59	51	46	41	33	27	
015	C	6	0.57	150	113	90	75	64	56	50	45	36	30	
	XC	3	0.60	158	118	95	79	68	59	53	47	38	32	
	XC	4	0.69	182	136	109	91	78	68	61	54	44	36	
02	C	5	0.77	203	152	122	101	87	76	68	61	49	41	
	C	6	0.85	224	168	134	112	96	84	75	67	54	45	
	XC	3	0.80	211	158	126	105	90	79	70	63	51	42	
03	XC	4	0.92	242	182	145	121	104	91	81	73	58	48	
	C	5	1.03	271	203	163	136	116	102	90	81	65	54	
	C	6	1.13	297	223	178	149	127	112	99	89	71	59	
04	XC	3	1.20	316	237	189	158	135	118	105	95	76	63	
	XC	4	1.39	366	274	219	183	157	137	122	110	88	73	
	VC	5	1.55	408	306	245	204	175	153	136	122	98	82	
05	C	6	1.70	447	336	268	224	192	168	149	134	107	89	
	XC	3	1.60	421	316	253	211	180	158	140	126	101	84	
	XC	4	1.85	487	365	292	243	209	183	162	146	117	97	
05	VC	5	2.07	545	409	327	272	233	204	182	163	131	109	
	C	6	2.26	595	446	357	297	255	223	198	178	143	119	
	XC	3	2.00	526	395	316	263	226	197	175	158	126	105	
05	XC	4	2.31	608	456	365	304	261	228	203	182	146	122	
	VC	5	2.58	679	509	407	339	291	255	226	204	163	136	
	C	6	2.83	745	559	447	372	319	279	248	223	179	149	

Droplet size based on ASABE S572.1 standard.

Features	
Common Use	Plant Health
Pattern	Tapered Flat Fan
Technology	Air Induction
Material	Ceramic
Spray Angle	110°
Pressure Range	40-100 PSI (3-7 BAR)
Configuration	Nozzles
Optimum Boom Height	
80° - 15" (35 cm) Spacing	20" (51 cm)
80° - 20" (50 cm) Spacing	28" (71 cm)
110° - 15" (35 cm) Spacing	13" (33 cm)
110° - 20" (50 cm) Spacing	18" (46 cm)
Part Numbers	
Nozzles 110°	Caps (25 Pack)
ATW-11001	CAP01-01
ATW-110015	CAP01-015
ATW-11002	CAP01-02
ATW-11003	CAP01-03
ATW-11004	CAP01-04
ATW-11005	CAP01-05

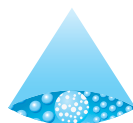

# GuardianAIR 110°



The Hypro GuardianAIR spray nozzle has a unique rearward spray incline provides more uniform coverage. Higher flow nozzles used at faster speeds have a greater spray incline.

- Air-induced sprays reduce drift while increasing droplet deposition and retention on foliage
- Provides better coverage with more drops per gallon or litre compared to other common air-induced spray nozzles
- Speed-optimized spray incline allows more uniform coverage
- Specifically engineered nozzle to maintain droplet spectrum regardless of orifice size
- FastCap includes nozzle, cap and gasket

## US Units

Nozzle Size	Droplet Size	Pressure (PSI)	Flow Rate (GPM)	Gallons per Acre 20 inch nozzle spacing MPH								GAL/1000 Ft <sup>2</sup> 20 inch nozzle spacing			
				4	5	6	8	10	12	15	20	2	3	4	5
015	UC	20	0.11	8.2	6.5	5.4	4.1	3.3	2.7	2.2	1.6	0.38	0.25	0.19	0.15
	XC	30	0.13	9.7	7.7	6.4	4.8	3.9	3.2	2.6	1.9	0.44	0.30	0.22	0.18
	C	40	0.15	11.1	8.9	7.4	5.6	4.5	3.7	3.0	2.2	0.51	0.34	0.26	0.20
	C	50	0.17	12.6	10.1	8.4	6.3	5.0	4.2	3.4	2.5	0.58	0.39	0.29	0.23
	M	60	0.18	13.4	10.7	8.9	6.7	5.3	4.5	3.6	2.7	0.61	0.41	0.31	0.25
	M	70	0.20	14.9	11.9	9.9	7.4	5.9	5.0	4.0	3.0	0.68	0.45	0.34	0.27
	M	80	0.21	15.6	12.5	10.4	7.8	6.2	5.2	4.2	3.1	0.72	0.48	0.36	0.29
	M	90	0.23	17.1	13.7	11.4	8.5	6.8	5.7	4.6	3.4	0.78	0.52	0.39	0.31
	M	100	0.24	17.8	14.3	11.9	8.9	7.1	5.9	4.8	3.6	0.82	0.55	0.41	0.33
	M	115	0.25	18.6	14.9	12.4	9.3	7.4	6.2	5.0	3.7	0.85	0.57	0.43	0.34
	02	XC	20	0.14	10.4	8.3	6.9	5.2	4.2	3.5	2.8	2.1	0.48	0.32	0.24
VC		30	0.17	12.6	10.1	8.4	6.3	5.0	4.2	3.4	2.5	0.58	0.39	0.29	0.23
M		40	0.20	14.9	11.9	9.9	7.4	5.9	5.0	4.0	3.0	0.68	0.45	0.34	0.27
M		50	0.22	16.3	13.1	10.9	8.2	6.5	5.4	4.4	3.3	0.75	0.50	0.38	0.30
M		60	0.24	17.8	14.3	11.9	8.9	7.1	5.9	4.8	3.6	0.82	0.55	0.41	0.33
M		70	0.26	19.3	15.4	12.9	9.7	7.7	6.4	5.1	3.9	0.89	0.59	0.44	0.35
M		80	0.28	20.8	16.6	13.9	10.4	8.3	6.9	5.5	4.2	0.95	0.64	0.48	0.38
M		90	0.30	22.3	17.8	14.9	11.1	8.9	7.4	5.9	4.5	1.02	0.68	0.51	0.41
M		100	0.32	23.8	19.0	15.8	11.9	9.5	7.9	6.3	4.8	1.09	0.73	0.55	0.44
M		115	0.34	25.2	20.2	16.8	12.6	10.1	8.4	6.7	5.0	1.16	0.77	0.58	0.46
025		XC	20	0.18	13.4	10.7	8.9	6.7	5.3	4.5	3.6	2.7	0.61	0.41	0.31
	VC	30	0.22	16.3	13.1	10.9	8.2	6.5	5.4	4.4	3.3	0.75	0.50	0.38	0.30
	C	40	0.25	18.6	14.9	12.4	9.3	7.4	6.2	5.0	3.7	0.85	0.57	0.43	0.34
	M	50	0.28	20.8	16.6	13.9	10.4	8.3	6.9	5.5	4.2	0.95	0.64	0.48	0.38
	M	60	0.31	23.0	18.4	15.3	11.5	9.2	7.7	6.1	4.6	1.06	0.70	0.53	0.42
	M	70	0.33	24.5	19.6	16.3	12.3	9.8	8.2	6.5	4.9	1.13	0.75	0.56	0.45
	M	80	0.35	26.0	20.8	17.3	13.0	10.4	8.7	6.9	5.2	1.19	0.80	0.60	0.48
	M	90	0.38	28.2	22.6	18.8	14.1	11.3	9.4	7.5	5.6	1.30	0.86	0.65	0.52
	M	100	0.40	29.7	23.8	19.8	14.9	11.9	9.9	7.9	5.9	1.36	0.91	0.68	0.55
	M	115	0.42	31.2	24.9	20.8	15.6	12.5	10.4	8.3	6.2	1.43	0.95	0.72	0.57
	03	UC	20	0.21	15.6	12.5	10.4	7.8	6.2	5.2	4.2	3.1	0.72	0.48	0.36
XC		30	0.26	19.3	15.4	12.9	9.7	7.7	6.4	5.1	3.9	0.89	0.59	0.44	0.35
VC		40	0.30	22.3	17.8	14.9	11.1	8.9	7.4	5.9	4.5	1.02	0.68	0.51	0.41
C		50	0.34	25.2	20.2	16.8	12.6	10.1	8.4	6.7	5.0	1.16	0.77	0.58	0.46
C		60	0.37	27.5	22.0	18.3	13.7	11.0	9.2	7.3	5.5	1.26	0.84	0.63	0.50
M		70	0.40	29.7	23.8	19.8	14.9	11.9	9.9	7.9	5.9	1.36	0.91	0.68	0.55
M		80	0.42	31.2	24.9	20.8	15.6	12.5	10.4	8.3	6.2	1.43	0.95	0.72	0.57
M		90	0.45	33.4	26.7	22.3	16.7	13.4	11.1	8.9	6.7	1.53	1.02	0.77	0.61
M		100	0.47	34.9	27.9	23.3	17.4	14.0	11.6	9.3	7.0	1.60	1.07	0.80	0.64
M		115	0.51	37.9	30.3	25.2	18.9	15.1	12.6	10.1	7.6	1.74	1.16	0.87	0.70
035		XC	20	0.25	18.6	14.9	12.4	9.3	7.4	6.2	5.0	3.7	0.85	0.57	0.43
	VC	30	0.30	22.3	17.8	14.9	11.1	8.9	7.4	5.9	4.5	1.02	0.68	0.51	0.41
	C	40	0.35	26.0	20.8	17.3	13.0	10.4	8.7	6.9	5.2	1.19	0.80	0.60	0.48
	M	50	0.39	29.0	23.2	19.3	14.5	11.6	9.7	7.7	5.8	1.33	0.89	0.66	0.53
	M	60	0.43	31.9	25.5	21.3	16.0	12.8	10.6	8.5	6.4	1.47	0.98	0.73	0.59
	M	70	0.46	34.2	27.3	22.8	17.1	13.7	11.4	9.1	6.8	1.57	1.05	0.78	0.63
	M	80	0.49	36.4	29.1	24.3	18.2	14.6	12.1	9.7	7.3	1.67	1.11	0.84	0.67
	M	90	0.53	39.4	31.5	26.2	19.7	15.7	13.1	10.5	7.9	1.81	1.20	0.90	0.72
	M	100	0.55	40.8	32.7	27.2	20.4	16.3	13.6	10.9	8.2	1.88	1.25	0.94	0.75
	M	115	0.59	43.8	35.0	29.2	21.9	17.5	14.6	11.7	8.8	2.01	1.34	1.01	0.80
	04	XC	20	0.28	20.8	16.6	13.9	10.4	8.3	6.9	5.5	4.2	0.95	0.64	0.48
VC		30	0.35	26.0	20.8	17.3	13.0	10.4	8.7	6.9	5.2	1.19	0.80	0.60	0.48
C		40	0.40	29.7	23.8	19.8	14.9	11.9	9.9	7.9	5.9	1.36	0.91	0.68	0.55
C		50	0.45	33.4	26.7	22.3	16.7	13.4	11.1	8.9	6.7	1.53	1.02	0.77	0.61
M		60	0.49	36.4	29.1	24.3	18.2	14.6	12.1	9.7	7.3	1.67	1.11	0.84	0.67
M		70	0.53	39.4	31.5	26.2	19.7	15.7	13.1	10.5	7.9	1.81	1.20	0.90	0.72
M		80	0.57	42.3	33.9	28.2	21.2	16.9	14.1	11.3	8.5	1.94	1.30	0.97	0.78
M		90	0.60	44.6	35.6	29.7	22.3	17.8	14.9	11.9	8.9	2.05	1.36	1.02	0.82
M		100	0.63	46.8	37.4	31.2	23.4	18.7	15.6	12.5	9.4	2.15	1.43	1.07	0.86
M		115	0.68	50.5	40.4	33.7	25.2	20.2	16.8	13.5	10.1	2.32	1.55	1.16	0.93
05		XC	20	0.35	26.0	20.8	17.3	13.0	10.4	8.7	6.9	5.2	1.19	0.80	0.60
	VC	30	0.43	31.9	25.5	21.3	16.0	12.8	10.6	8.5	6.4	1.47	0.98	0.73	0.59
	C	40	0.50	37.1	29.7	24.8	18.6	14.9	12.4	9.9	7.4	1.71	1.14	0.85	0.68
	C	50	0.56	41.6	33.3	27.7	20.8	16.6	13.9	11.1	8.3	1.91	1.27	0.95	0.76
	M	60	0.61	45.3	36.2	30.2	22.6	18.1	15.1	12.1	9.1	2.08	1.39	1.04	0.83
	M	70	0.66	49.0	39.2	32.7	24.5	19.6	16.3	13.1	9.8	2.25	1.50	1.13	0.90
	M	80	0.71	52.7	42.2	35.1	26.4	21.1	17.6	14.1	10.5	2.42	1.61	1.21	0.97
	M	90	0.75	55.7	44.6	37.1	27.8	22.3	18.6	14.9	11.1	2.56	1.71	1.28	1.02
	M	100	0.79	58.7	46.9	39.1	29.3	23.5	19.6	15.6	11.7	2.69	1.80	1.35	1.08
	M	115	0.85	63.1	50.5	42.1	31.6	25.2	21.0	16.8	12.6	2.90	1.93	1.45	1.16

Droplet size based on ASABE S572.1 standard.

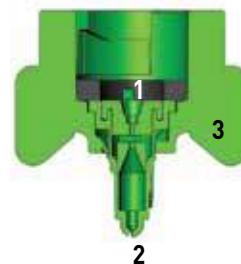

1. Single Inlet; Air Inducted Technology
2. Inclined spray pattern provides more uniform coverage
3. Available in a Fastcap option for easy installation



Flexible 110° air inducted spray pattern capable of meeting many spraying situations.



Unique angle of incline specifically engineered to maximize droplet deposition on vertical targets.



See [www.hyprospraytips.com/certifications](http://www.hyprospraytips.com/certifications) for the latest drift reduction standard information.

**Metric Units**

Nozzle Size	Droplet Size	Pressure (BAR)	Flow Rate (LPM)	Application Rate L/Ha -50 cm Spacing								Drift Reduction Standards			
				7	8	10	12	15	20	25	30	LERAP	JKI	Z.N.T.	TCT
015	UC	1	0,35	60	53	42	35	28	21	17	14	★★★★ 75% + 1.0-1.25 BAR ★★ 50-75% 1.3-2.0 BAR		66%	50%
	UC	1,5	0,42	72	63	50	42	34	25	20	17				
	XC	2	0,49	84	74	59	49	39	29	24	20				
	C	3	0,60	103	90	72	60	48	36	29	24				
	M	4	0,69	118	104	83	69	55	41	33	28				
	M	5	0,77	132	116	92	77	62	46	37	31				
	M	6	0,85	146	128	102	85	68	51	41	34				
	M	7	0,92	158	138	110	92	74	55	44	37				
02	UC	1	0,46	79	69	55	46	37	28	22	18	★★★★ 75% + 1.0-1.25 BAR ★★ 50-75% 1.3-2.0 BAR	50% Ref # G-1812	66%	50%
	XC	1,5	0,57	98	86	68	57	46	34	27	23				
	VC	2	0,65	111	98	78	65	52	39	31	26				
	M	3	0,80	137	120	96	80	64	48	38	32				
	M	4	0,92	158	138	110	92	74	55	44	37				
	M	5	1,03	177	155	124	103	82	62	49	41				
	M	6	1,13	194	170	136	113	90	68	54	45				
	M	7	1,22	209	183	146	122	98	73	59	49				
025	UC	1	0,58	99	87	70	58	46	35	28	23	★★★★ 75% + 1.0-1.5 BAR ★★ 50-75% 1.6-2.5 BAR	50% Ref # G-1817	66%	75% 1.0-1.5 BAR 50% 1.6-2.5 BAR
	XC	1,5	0,71	122	107	85	71	57	43	34	28				
	VC	2	0,82	141	123	98	82	66	49	39	33				
	C	3	1,00	171	150	120	100	80	60	48	40				
	M	4	1,15	197	173	138	115	92	69	55	46				
	M	5	1,29	221	194	155	129	103	77	62	52				
	M	6	1,41	242	212	169	141	113	85	68	56				
	M	7	1,53	262	230	184	153	122	92	73	61				
03	UC	1	0,69	118	104	83	69	55	41	33	28	★★★★ 75% + 1.0-1.5 BAR ★★ 50-75% 1.6-2.5 BAR	75% 1.5 BAR 50% 1.6-2.5 BAR Ref # G-1813	66%	75% 1.0-1.5 BAR 50% 1.6-2.5 BAR
	UC	1,5	0,85	146	128	102	85	68	51	41	34				
	XC	2	0,98	168	147	118	98	78	59	47	39				
	VC	3	1,20	206	180	144	120	96	72	58	48				
	C	4	1,39	238	209	167	139	111	83	67	56				
	M	5	1,55	266	233	186	155	124	93	74	62				
	M	6	1,70	291	255	204	170	136	102	82	68				
	M	7	1,83	314	275	220	183	146	110	88	73				
035	UC	1	0,81	139	122	97	81	65	49	39	32	★★★★ 75% + 1.0-1.5 BAR ★★ 50-75% 1.6-4.0 BAR	75% 1.0-1.5 BAR 50% 1.6-2.5 BAR Ref # G-1811	66%	75% 1.0-1.5 BAR 50% 1.6-4.0 BAR
	XC	1,5	0,99	170	149	119	99	79	59	48	40				
	VC	2	1,14	195	171	137	114	91	68	55	46				
	C	3	1,40	240	210	168	140	112	84	67	56				
	M	4	1,62	278	243	194	162	130	97	78	65				
	M	5	1,81	310	272	217	181	145	109	87	72				
	M	6	1,98	339	297	238	198	158	119	95	79				
	M	7	2,14	367	321	257	214	171	128	103	86				
04	UC	1	0,92	158	138	110	92	74	55	44	37	★★★★ 75% + 1.0-1.5 BAR ★★ 50-75% 1.6-4.0 BAR	75% 1.0-1.5 BAR 50% 1.6-2.5 BAR Ref # G-1814	66%	75% 1.0-1.5 BAR 50% 1.6-4.0 BAR
	XC	1,5	1,13	194	170	136	113	90	68	54	45				
	VC	2	1,31	225	197	157	131	105	79	63	52				
	C	3	1,60	274	240	192	160	128	96	77	64				
	M	4	1,85	317	278	222	185	148	111	89	74				
	M	5	2,07	355	311	248	207	166	124	99	83				
	M	6	2,26	387	339	271	226	181	136	108	90				
	M	7	2,44	418	366	293	244	195	146	117	98				
05	UC	1	1,15	197	173	138	115	92	69	55	46	★★★★ 75% + 1.0-1.5 BAR ★★ 50-75% 1.6-4.0 BAR	75% 1.0-1.5 BAR 50% 1.6-2.5 BAR Ref # G-1815	66%	75% 1.0-1.5 BAR 50% 1.6-4.0 BAR
	XC	1,5	1,41	242	212	169	141	113	85	68	56				
	XC	2	1,63	279	245	196	163	130	98	78	65				
	C	3	2,00	343	300	240	200	160	120	96	80				
	M	4	2,31	396	347	277	231	185	139	111	92				
	M	5	2,58	442	387	310	258	206	155	124	103				
	M	6	2,83	485	425	340	283	226	170	136	113				
	M	7	3,06	525	459	367	306	245	184	147	122				
M	8	3,27	561	491	392	327	262	196	157	131					

Droplet size based on ASABE S572.1 standard.  
Use at 3 bar for optimum coverage.

Features	
Common Use	Plant Health
Pattern	Tapered Flat Fan
Technology	Air Induction
Material	Polyacetal
Spray Angle	110°
Pressure Range	20-115 PSI (1-8 BAR)
Configuration	Nozzles, FastCap
Optimum Boom Height	
15" [35 cm] Spacing	15" [35 cm]
20" [50 cm] Spacing	20" [50 cm]
Part Numbers	
Nozzles 110°	FastCaps 110°
GA110-015	FC-GA110-015
GA110-02	FC-GA110-02
GA110-025	FC-GA110-025
GA110-03	FC-GA110-03
GA110-035	FC-GA110-035
GA110-04	FC-GA110-04
GA110-05	FC-GA110-05
Replacement Cap Gasket	
22W11MF64	



# Ceramic AVI 110°



The Albus<sup>®</sup> AVI draws air into the nozzle and mixes it with the spray to create very coarse droplets that minimize spray drift. The air-filled droplets have a larger footprint on the leaf than similar non-air droplets and hold to the leaf for better control. Durable Albus ceramic orifice create the longest wearing spray nozzle of its kind.

- Excellent drift reduction with large air-filled droplets
- Large passages resist plugging
- Wear-resistant Albus ceramic orifice
- 80° fan models ideal for use in directed spray applications (See page 179 for more information)
- FastCap includes nozzle, cap and gasket

## US Units

Nozzle Size	Droplet Size 110°	Pressure (PSI)	Flow Rate (GPM)	Gallons per Acre 20 inch nozzle spacing MPH								GAL/1000 ft <sup>2</sup> 20 inch nozzle spacing				
				4	5	6	8	10	12	15	20	2	3	4	5	
01	VC	30	0.09	6.7	5.3	4.5	3.3	2.7	2.2	1.8	1.3	0.31	0.20	0.15	0.12	
	VC	40	0.10	7.4	5.9	5.0	3.7	3.0	2.5	2.0	1.5	0.34	0.23	0.17	0.14	
	C	50	0.11	8.2	6.5	5.4	4.1	3.3	2.7	2.2	1.6	0.38	0.25	0.19	0.15	
	C	60	0.12	8.9	7.1	5.9	4.5	3.6	3.0	2.4	1.8	0.41	0.27	0.20	0.16	
	C	70	0.13	9.7	7.7	6.4	4.8	3.9	3.2	2.6	1.9	0.44	0.30	0.22	0.18	
	C	80	0.14	10.4	8.3	6.9	5.2	4.2	3.5	2.8	2.1	0.48	0.32	0.24	0.19	
	C	100	0.16	11.1	8.9	7.4	5.6	4.5	3.7	3.0	2.2	0.51	0.34	0.26	0.20	
015	VC	30	0.13	9.7	7.7	6.4	4.8	3.9	3.2	2.6	1.9	0.44	0.30	0.22	0.18	
	VC	40	0.15	11.1	8.9	7.4	5.6	4.5	3.7	3.0	2.2	0.51	0.34	0.26	0.20	
	C	50	0.17	12.6	10.1	8.4	6.3	5.0	4.2	3.4	2.5	0.58	0.39	0.29	0.23	
	C	60	0.18	13.4	10.7	8.9	6.7	5.3	4.5	3.6	2.7	0.61	0.41	0.31	0.25	
	C	70	0.20	14.9	11.9	9.9	7.4	5.9	5.0	4.0	3.0	0.68	0.45	0.34	0.27	
	C	80	0.21	15.6	12.5	10.4	7.8	6.2	5.2	4.2	3.1	0.72	0.48	0.36	0.29	
	C	100	0.23	17.1	13.7	11.4	8.5	6.8	5.7	4.6	3.4	0.78	0.52	0.39	0.31	
02	VC	30	0.17	12.6	10.1	8.4	6.3	5.0	4.2	3.4	2.5	0.58	0.39	0.29	0.23	
	VC	40	0.20	14.9	11.9	9.9	7.4	5.9	5.0	4.0	3.0	0.68	0.45	0.34	0.27	
	C	50	0.22	16.3	13.1	10.9	8.2	6.5	5.4	4.4	3.3	0.75	0.50	0.38	0.30	
	C	60	0.24	17.8	14.3	11.9	8.9	7.1	5.9	4.8	3.6	0.82	0.55	0.41	0.33	
	C	70	0.26	19.3	15.4	12.9	9.7	7.7	6.4	5.1	3.9	0.89	0.59	0.44	0.35	
	C	80	0.28	20.8	16.6	13.9	10.4	8.3	6.9	5.5	4.2	0.95	0.64	0.48	0.38	
	C	100	0.30	22.3	17.8	14.9	11.1	8.9	7.4	5.9	4.5	1.02	0.68	0.51	0.41	
025	XC	30	0.22	16.3	13.1	10.9	8.2	6.5	5.4	4.4	3.3	0.75	0.50	0.38	0.30	
	VC	40	0.25	18.6	14.9	12.4	9.3	7.4	6.2	5.0	3.7	0.85	0.57	0.43	0.34	
	C	50	0.28	20.8	16.6	13.9	10.4	8.3	6.9	5.5	4.2	0.95	0.64	0.48	0.38	
	C	60	0.31	23.0	18.4	15.3	11.5	9.2	7.7	6.1	4.6	1.06	0.70	0.53	0.42	
	C	70	0.33	24.5	19.6	16.3	12.3	9.8	8.2	6.5	4.9	1.13	0.75	0.56	0.45	
	C	80	0.35	26.0	20.8	17.3	13.0	10.4	8.7	6.9	5.2	1.19	0.80	0.60	0.48	
	C	100	0.38	28.2	22.6	18.8	14.1	11.3	9.4	7.5	5.6	1.30	0.86	0.65	0.52	
03	XC	30	0.26	19.3	15.4	12.9	9.7	7.7	6.4	5.1	3.9	0.89	0.59	0.44	0.35	
	VC	40	0.30	22.3	17.8	14.9	11.1	8.9	7.4	5.9	4.5	1.02	0.68	0.51	0.41	
	C	50	0.34	25.2	20.2	16.8	12.6	10.1	8.4	6.7	5.0	1.16	0.77	0.58	0.46	
	C	60	0.37	27.5	22.0	18.3	13.7	11.0	9.2	7.3	5.5	1.26	0.84	0.63	0.50	
	C	70	0.40	29.7	23.8	19.8	14.9	11.9	9.9	7.9	5.9	1.36	0.91	0.68	0.55	
	C	80	0.42	31.2	24.9	20.8	15.6	12.5	10.4	8.3	6.2	1.43	0.95	0.72	0.57	
	C	100	0.45	33.4	26.7	22.3	16.7	13.4	11.1	8.9	6.7	1.53	1.02	0.77	0.61	
04	XC	30	0.35	26.0	20.8	17.3	13.0	10.4	8.7	6.9	5.2	1.19	0.80	0.60	0.48	
	VC	40	0.40	29.7	23.8	19.8	14.9	11.9	9.9	7.9	5.9	1.36	0.91	0.68	0.55	
	C	50	0.45	33.4	26.7	22.3	16.7	13.4	11.1	8.9	6.7	1.53	1.02	0.77	0.61	
	C	60	0.49	36.4	29.1	24.3	18.2	14.6	12.1	9.7	7.3	1.67	1.11	0.84	0.67	
	C	70	0.53	39.4	31.5	26.2	19.7	15.7	13.1	10.5	7.9	1.81	1.20	0.90	0.72	
	C	80	0.57	42.3	33.9	28.2	21.2	16.9	14.1	11.3	8.5	1.94	1.30	0.97	0.78	
	C	100	0.60	44.6	35.6	29.7	22.3	17.8	14.9	11.9	8.9	2.05	1.36	1.02	0.82	
05	XC	30	0.43	31.9	25.5	21.3	16.0	12.8	10.6	8.5	6.4	1.47	0.98	0.73	0.59	
	VC	40	0.50	37.1	29.7	24.8	18.6	14.9	12.4	9.9	7.4	1.71	1.14	0.85	0.68	
	C	50	0.56	41.6	33.3	27.7	20.8	16.6	13.9	11.1	8.3	1.91	1.27	0.95	0.76	
	C	60	0.61	45.3	36.2	30.2	22.6	18.1	15.1	12.1	9.1	2.08	1.39	1.04	0.83	
	C	70	0.66	49.0	39.2	32.7	24.5	19.6	16.3	13.1	9.8	2.25	1.50	1.13	0.90	
	C	80	0.71	52.7	42.2	35.1	26.4	21.1	17.6	14.1	10.5	2.42	1.61	1.21	0.97	
	C	100	0.75	55.7	44.6	37.1	27.8	22.3	18.6	14.9	11.1	2.56	1.71	1.28	1.02	
06	XC	30	0.52	38.6	30.9	25.7	19.3	15.4	12.9	10.3	7.7	1.77	1.18	0.89	0.71	
	VC	40	0.60	44.6	35.6	29.7	22.3	17.8	14.9	11.9	8.9	2.05	1.36	1.02	0.82	
	C	50	0.67	49.7	39.8	33.2	24.9	19.9	16.6	13.3	9.9	2.28	1.52	1.14	0.91	
	C	60	0.73	54.2	43.4	36.1	27.1	21.7	18.1	14.5	10.8	2.49	1.66	1.24	1.00	
	C	70	0.79	58.7	46.9	39.1	29.3	23.5	19.6	15.6	11.7	2.69	1.80	1.35	1.08	
	C	80	0.85	63.1	50.5	42.1	31.6	25.2	21.0	16.8	12.6	2.90	1.93	1.45	1.16	
	C	100	0.90	66.8	53.5	44.6	33.4	26.7	22.3	17.8	13.4	3.07	2.05	1.53	1.23	
08	XC	30	0.69	51.2	41.0	34.2	25.6	20.5	17.1	13.7	10.2	2.35	1.57	1.18	0.94	
	VC	40	0.80	59.4	47.5	39.6	29.7	23.8	19.8	15.8	11.9	2.73	1.82	1.36	1.09	
	C	50	0.89	66.1	52.9	44.1	33.0	26.4	22.0	17.6	13.2	3.03	2.02	1.52	1.21	
	C	60	0.98	72.8	58.2	48.5	36.4	29.1	24.3	19.4	14.6	3.34	2.23	1.67	1.34	
	C	70	1.06	78.7	63.0	52.5	39.4	31.5	26.2	21.0	15.7	3.61	2.41	1.81	1.45	
	C	80	1.13	83.9	67.1	55.9	42.0	33.6	28.0	22.4	16.8	3.85	2.57	1.93	1.54	
	C	100	1.20	89.1	71.3	59.4	44.6	35.6	29.7	23.8	17.8	4.09	2.73	2.05	1.64	
10	XC	30	0.87	64.6	51.7	43.1	32.3	25.8	21.5	17.2	12.9	2.97	1.98	1.48	1.19	
	VC	40	1.00	74.3	59.4	49.5	37.1	29.7	24.8	19.8	14.9	3.41	2.27	1.71	1.36	
	C	50	1.10	83.2	66.5	55.4	41.6	33.3	27.7	22.2	16.6	3.82	2.55	1.91	1.53	
	C	60	1.22	90.6	72.5	60.4	45.3	36.2	30.2	24.2	18.1	4.16	2.77	2.08	1.66	
	C	70	1.32	98.0	78.4	65.3	49.0	39.2	32.7	26.1	19.6	4.50	3.00	2.25	1.80	
	C	80	1.41	105	83.8	69.8	52.3	41.9	34.9	27.9	20.9	4.81	3.21	2.40	1.92	
	C	100	1.50	111	89.1	74.3	55.7	44.6	37.1	29.7	22.3	5.12	3.41	2.56	2.05	

Albus<sup>®</sup> is a registered trademark of SAINT-GOBAIN SOLCERA, SAINT-GOBAIN CERAMIQUES AVANCEES DESMARQUEST, CERAMIQUES TECHNIQUES DESMARQUEST, and SOCIETE DESMARQUEST ET CEC.

Hypro<sup>®</sup> is a registered trademark of Pentair.

Droplet size based on ASABE S572.1 standard.





### Metric Units

Nozzle Size	Droplet Size 110°	Pressure (bar)	Flow (L/min)	Application Rate L/Ha- 50 cm Spacing KM/H									
				6	8	10	12	14	16	18	20	25	30
01	VC	2	0.33	87	65	52	43	37	33	29	26	21	17
	VC	3	0.40	105	79	63	53	45	39	35	32	25	21
	VC	4	0.46	121	91	73	61	52	45	40	36	29	24
	C	5	0.52	137	103	82	68	59	51	46	41	33	27
	C	6	0.57	150	113	90	75	64	56	50	45	36	30
	C	7	0.61	161	120	96	80	69	60	54	48	39	32
	VC	2	0.49	129	97	77	64	55	48	43	39	31	26
015	VC	3	0.60	158	118	95	79	68	59	53	47	38	32
	VC	4	0.69	182	136	109	91	78	68	61	54	44	36
	VC	5	0.77	203	152	122	101	87	76	68	61	49	41
	C	6	0.85	224	168	134	112	96	84	75	67	54	45
	C	7	0.92	242	182	145	121	104	91	81	73	58	48
	VC	2	0.65	171	128	103	86	73	64	57	51	41	34
	VC	3	0.80	211	158	126	105	90	79	70	63	51	42
02	VC	4	0.92	242	182	145	121	104	91	81	73	58	48
	VC	5	1.03	271	203	163	136	116	102	90	81	65	54
	VC	6	1.13	297	223	178	149	127	112	99	89	71	59
	C	7	1.22	321	241	193	161	138	120	107	96	77	64
	XC	2	0.82	216	162	129	108	92	81	72	65	52	43
	VC	3	1.00	263	197	158	132	113	99	88	79	63	53
	VC	4	1.15	303	227	182	151	130	113	101	91	73	61
025	VC	5	1.29	339	255	204	170	145	127	113	102	81	68
	VC	6	1.41	371	278	223	186	159	139	124	111	89	74
	VC	7	1.53	403	302	242	201	173	151	134	121	97	81
	XC	2	0.98	258	193	155	129	111	97	86	77	62	52
	XC	3	1.20	316	237	189	158	135	118	105	95	76	63
	VC	4	1.39	366	274	219	183	157	137	122	110	88	73
	VC	5	1.55	408	306	245	204	175	153	136	122	98	82
03	VC	6	1.70	447	336	268	224	192	168	149	134	107	89
	VC	7	1.83	482	361	289	241	206	181	161	144	116	96
	XC	2	1.31	345	259	207	172	148	129	115	103	83	69
	XC	3	1.60	421	316	253	211	180	158	140	126	101	84
	VC	4	1.85	487	365	292	243	209	183	162	146	117	97
	VC	5	2.07	545	409	327	272	233	204	182	163	131	109
	VC	6	2.26	595	446	357	297	255	223	198	178	143	119
04	VC	7	2.44	642	482	385	321	275	241	214	193	154	128
	XC	2	1.63	429	322	257	214	184	161	143	129	103	86
	XC	3	2.00	526	395	316	263	226	197	175	158	126	105
	XC	4	2.31	608	456	365	304	261	228	203	182	146	122
	VC	5	2.58	679	509	407	339	291	255	226	204	163	136
	VC	6	2.83	745	559	447	372	319	279	248	223	179	149
	VC	7	3.06	805	604	483	403	345	302	268	242	193	161
05	XC	2	1.96	516	387	309	258	221	193	172	155	124	103
	XC	3	2.40	632	474	379	316	271	237	211	189	152	126
	XC	4	2.77	729	547	437	364	312	273	243	219	175	146
	VC	5	3.10	816	612	489	408	350	306	272	245	196	163
	VC	6	3.39	892	669	535	446	382	335	297	268	214	178
	VC	7	3.67	966	724	579	483	414	362	322	290	232	193
	06	XC	2	2.61	687	515	412	343	294	258	229	206	165
XC		3	3.20	842	632	505	421	361	316	281	253	202	168
XC		4	3.70	974	730	584	487	417	365	325	292	234	195
XC		5	4.13	1087	815	652	543	466	408	362	326	261	217
XC		6	4.53	1192	894	715	596	511	447	397	358	286	238
XC		7	4.89	1287	965	772	643	552	483	429	386	309	257
08		XC	2	3.27	861	645	516	430	369	323	287	258	207
	XC	3	4.00	1053	789	632	526	451	395	351	316	253	211
	XC	4	4.62	1216	912	729	608	521	456	405	365	292	243
	XC	5	5.16	1358	1018	815	679	582	509	453	407	326	272
	XC	6	5.66	1489	1117	894	745	638	559	496	447	357	298
	XC	7	6.11	1608	1206	965	804	689	603	536	482	386	322

Droplet size based on ASABE S572.1 standard.

Features	
Common Use	Weeds
Pattern	Tapered Flat Fan
Technology	Air Induction
Material	Ceramic
Spray Angle	110°
Pressure Range	30-100 PSI (2-7 BAR)
Configuration	Nozzles, FastCap Complete
Optimum Boom Height	
80° - 15" (35 cm) Spacing	22" (56 cm)
80° - 20" (50 cm) Spacing	30" (76 cm)
110° - 15" (35 cm) Spacing	15" (35 cm)
110° - 20" (50 cm) Spacing	20" (50 cm)
Nozzles	FastCaps
AVI-11001	FC-AVI-11001
AVI-110015	FC-AVI-110015
AVI-11002	FC-AVI-11002
AVI-110025	FC-AVI-110025
AVI-11003	FC-AVI-11003
AVI-11004	FC-AVI-11004
AVI-11005	FC-AVI-11005
AVI-11006	FC-AVI-11006
AVI-11008	FC-AVI-11008
AVI-11010	FC-AVI-11010
Replacement Cap Gasket	
22W11MF64	



# Guardian 120°



Guardian spray nozzles are ideal for insecticide and fungicide applications especially when used with suspension based adjuvants. The Guardian's unique 20° inclined spray pattern allows users to aim the spray rearward for general spraying, forward for vertical targets, or alternate nozzles to create a twin spray.

- Pre-orifice design for courser spray availability the flat fans
- Delivers a consistent droplet and spray pattern
- A bold arrow indicates incline direction for easy installation
- FastCap complete includes nozzle, cap, gasket and integrated strainers

Nozzle Size	Droplet Size	Pressure (PSI)	Flow Rate (GPM)	Gallons per Acre 20 inch nozzle spacing MPH								GAL/1000 F <sup>2</sup> 20 inch nozzle spacing				
				4	5	6	8	10	12	15	20	2	3	4	5	
015	M	20	0.11	8.2	6.5	5.4	4.1	3.3	2.7	2.2	1.6	0.38	0.25	0.19	0.15	
	M	30	0.13	9.7	7.7	6.4	4.8	3.9	3.2	2.6	1.9	0.44	0.30	0.22	0.18	
	M	40	0.15	11.1	8.9	7.4	5.6	4.5	3.7	3.0	2.2	0.51	0.34	0.26	0.20	
	M	50	0.17	12.6	10.1	8.4	6.3	5.0	4.2	3.4	2.5	0.58	0.39	0.29	0.23	
	M	60	0.18	13.4	10.7	8.9	6.7	5.3	4.5	3.6	2.7	0.61	0.41	0.31	0.25	
	M	70	0.20	14.9	11.9	9.9	7.4	5.9	5.0	4.0	3.0	0.68	0.45	0.34	0.27	
	M	80	0.21	15.6	12.5	10.4	7.8	6.2	5.2	4.2	3.1	0.72	0.48	0.36	0.29	
	M	90	0.23	17.1	13.7	11.4	8.5	6.8	5.7	4.6	3.4	0.78	0.52	0.39	0.31	
	M	100	0.24	17.8	14.3	11.9	8.9	7.1	5.9	4.8	3.6	0.82	0.55	0.41	0.33	
	M	115	0.25	18.6	14.9	12.4	9.3	7.4	6.2	5.0	3.7	0.85	0.57	0.43	0.34	
	02	M	20	0.14	10.4	8.3	6.9	5.2	4.2	3.5	2.8	2.1	0.48	0.32	0.24	0.19
M		30	0.17	12.6	10.1	8.4	6.3	5.0	4.2	3.4	2.5	0.58	0.39	0.29	0.23	
M		40	0.20	14.9	11.9	9.9	7.4	5.9	5.0	4.0	3.0	0.68	0.45	0.34	0.27	
M		50	0.22	16.3	13.1	10.9	8.2	6.5	5.4	4.4	3.3	0.75	0.50	0.38	0.30	
M		60	0.24	17.8	14.3	11.9	8.9	7.1	5.9	4.8	3.6	0.82	0.55	0.41	0.33	
M		70	0.26	19.3	15.4	12.9	9.7	7.7	6.4	5.1	3.9	0.89	0.59	0.44	0.35	
M		80	0.28	20.8	16.6	13.9	10.4	8.3	6.9	5.5	4.2	0.95	0.64	0.48	0.38	
M		90	0.30	22.3	17.8	14.9	11.1	8.9	7.4	5.9	4.5	1.02	0.68	0.51	0.41	
M		100	0.32	23.8	19.0	15.8	11.9	9.5	7.9	6.3	4.8	1.09	0.73	0.55	0.44	
M		115	0.34	25.2	20.2	16.8	12.6	10.1	8.4	6.7	5.0	1.16	0.77	0.58	0.46	
025		M	20	0.18	13.4	10.7	8.9	6.7	5.3	4.5	3.6	2.7	0.61	0.41	0.31	0.25
	M	30	0.22	16.3	13.1	10.9	8.2	6.5	5.4	4.4	3.3	0.75	0.50	0.38	0.30	
	M	40	0.25	18.6	14.9	12.4	9.3	7.4	6.2	5.0	3.7	0.85	0.57	0.43	0.34	
	M	50	0.28	20.8	16.6	13.9	10.4	8.3	6.9	5.5	4.2	0.95	0.64	0.48	0.38	
	M	60	0.31	23.0	18.4	15.3	11.5	9.2	7.7	6.1	4.6	1.06	0.70	0.53	0.42	
	M	70	0.33	24.5	19.6	16.3	12.3	9.8	8.2	6.5	4.9	1.13	0.75	0.56	0.45	
	M	80	0.35	26.0	20.8	17.3	13.0	10.4	8.7	6.9	5.2	1.19	0.80	0.60	0.48	
	M	90	0.38	28.2	22.6	18.8	14.1	11.3	9.4	7.5	5.6	1.30	0.86	0.65	0.52	
	M	100	0.40	29.7	23.8	19.8	14.9	11.9	9.9	7.9	5.9	1.36	0.91	0.68	0.55	
	M	115	0.42	31.2	24.9	20.8	15.6	12.5	10.4	8.3	6.2	1.43	0.95	0.72	0.57	
	03	M	20	0.21	15.6	12.5	10.4	7.8	6.2	5.2	4.2	3.1	0.72	0.48	0.36	0.29
M		30	0.26	19.3	15.4	12.9	9.7	7.7	6.4	5.1	3.9	0.89	0.59	0.44	0.35	
M		40	0.30	22.3	17.8	14.9	11.1	8.9	7.4	5.9	4.5	1.02	0.68	0.51	0.41	
M		50	0.34	25.2	20.2	16.8	12.6	10.1	8.4	6.7	5.0	1.16	0.77	0.58	0.46	
M		60	0.37	27.5	22.0	18.3	13.7	11.0	9.2	7.3	5.5	1.26	0.84	0.63	0.50	
M		70	0.40	29.7	23.8	19.8	14.9	11.9	9.9	7.9	5.9	1.36	0.91	0.68	0.55	
M		80	0.42	31.2	24.9	20.8	15.6	12.5	10.4	8.3	6.2	1.43	0.95	0.72	0.57	
M		90	0.45	33.4	26.7	22.3	16.7	13.4	11.1	8.9	6.7	1.53	1.02	0.77	0.61	
M		100	0.47	34.9	27.9	23.3	17.4	14.0	11.6	9.3	7.0	1.60	1.07	0.80	0.64	
M		115	0.51	37.9	30.3	25.2	18.9	15.1	12.6	10.1	7.6	1.74	1.16	0.87	0.70	
04		VC	20	0.28	20.8	16.6	13.9	10.4	8.3	6.9	5.5	4.2	0.95	0.64	0.48	0.38
	VC	30	0.35	26.0	20.8	17.3	13.0	10.4	8.7	6.9	5.2	1.19	0.80	0.60	0.48	
	C	40	0.40	29.7	23.8	19.8	14.9	11.9	9.9	7.9	5.9	1.36	0.91	0.68	0.55	
	C	50	0.45	33.4	26.7	22.3	16.7	13.4	11.1	8.9	6.7	1.53	1.02	0.77	0.61	
	C	60	0.49	36.4	29.1	24.3	18.2	14.6	12.1	9.7	7.3	1.67	1.11	0.84	0.67	
	M	70	0.53	39.4	31.5	26.2	19.7	15.7	13.1	10.5	7.9	1.81	1.20	0.90	0.72	
	M	80	0.57	42.3	33.9	28.2	21.2	16.9	14.1	11.3	8.5	1.94	1.30	0.97	0.78	
	M	90	0.60	44.6	35.6	29.7	22.3	17.8	14.9	11.9	8.9	2.05	1.36	1.02	0.82	
	M	100	0.63	46.8	37.4	31.2	23.4	18.7	15.6	12.5	9.4	2.15	1.43	1.07	0.86	
	M	115	0.68	50.5	40.4	33.7	25.2	20.2	16.8	13.5	10.1	2.32	1.55	1.16	0.93	
	05	XC	20	0.35	26.0	20.8	17.3	13.0	10.4	8.7	6.9	5.2	1.19	0.80	0.60	0.48
XC		30	0.43	31.9	25.5	21.3	16.0	12.8	10.6	8.5	6.4	1.47	0.98	0.73	0.59	
VC		40	0.50	37.1	29.7	24.8	18.6	14.9	12.4	9.9	7.4	1.71	1.14	0.85	0.68	
VC		50	0.56	41.6	33.3	27.7	20.8	16.6	13.9	11.1	8.3	1.91	1.27	0.95	0.76	
M		60	0.61	45.3	36.2	30.2	22.6	18.1	15.1	12.1	9.1	2.08	1.39	1.04	0.83	
M		70	0.66	49.0	39.2	32.7	24.5	19.6	16.3	13.1	9.8	2.25	1.50	1.13	0.90	
M		80	0.71	52.7	42.2	35.1	26.4	21.1	17.6	14.1	10.5	2.42	1.61	1.21	0.97	
M		90	0.75	55.7	44.6	37.1	27.8	22.3	18.6	14.9	11.1	2.56	1.71	1.28	1.02	
M		100	0.79	58.7	46.9	39.1	29.3	23.5	19.6	15.6	11.7	2.69	1.80	1.35	1.08	
M		115	0.85	63.1	50.5	42.1	31.6	25.2	21.0	16.8	12.6	2.90	1.93	1.45	1.16	
06		XC	20	0.42	31.2	24.9	20.8	15.6	12.5	10.4	8.3	6.2	1.43	0.95	0.72	0.57
	XC	30	0.52	38.6	30.9	25.7	19.3	15.4	12.9	10.3	7.7	1.77	1.18	0.89	0.71	
	VC	40	0.60	44.6	35.6	29.7	22.3	17.8	14.9	11.9	8.9	2.05	1.36	1.02	0.82	
	VC	50	0.67	49.7	39.8	33.2	24.9	19.9	16.6	13.3	9.9	2.28	1.52	1.14	0.91	
	M	60	0.73	54.2	43.4	36.1	27.1	21.7	18.1	14.5	10.8	2.49	1.66	1.24	1.00	
	M	70	0.79	58.7	46.9	39.1	29.3	23.5	19.6	15.6	11.7	2.69	1.80	1.35	1.08	
	M	80	0.85	63.1	50.5	42.1	31.6	25.2	21.0	16.8	12.6	2.90	1.93	1.45	1.16	
	M	90	0.90	66.8	53.5	44.6	33.4	26.7	22.3	17.8	13.4	3.07	2.05	1.53	1.23	
	M	100	0.95	70.5	56.4	47.0	35.3	28.2	23.5	18.8	14.1	3.24	2.16	1.62	1.30	
	M	115	1.02	75.7	60.6	50.5	37.9	30.3	25.2	20.2	15.1	3.48	2.32	1.74	1.39	
	08	XC	20	0.57	42.3	33.9	28.2	21.2	16.9	14.1	11.3	8.5	1.94	1.30	0.97	0.78
VC		30	0.69	51.2	41.0	34.2	25.6	20.5	17.1	13.7	10.2	2.35	1.57	1.18	0.94	
VC		40	0.80	59.4	47.5	39.6	29.7	23.8	19.8	15.8	11.9	2.73	1.82	1.36	1.09	
M		50	0.89	66.1	52.9	44.1	33.0	26.4	22.0	17.6	13.2	3.03	2.02	1.52	1.21	
M		60	0.98	72.8	58.2	48.5	36.4	29.1	24.3	19.4	14.6	3.34	2.23	1.67	1.34	
M		70	1.06	78.7	63.0	52.5	39.4	31.5	26.2	21.0	15.7	3.61	2.41	1.81	1.45	
M		80	1.13	83.9	67.1	55.9	42.0	33.6	28.0	22.4	16.8	3.85	2.57	1.93	1.54	
M		90	1.20	89.1	71.3	59.4	44.6	35.6	29.7	23.8	17.8	4.09	2.73	2.05	1.64	
M		100	1.26	93.6	74.8	62.4	46.8	37.4								



120° wide, non-air induced spray pattern for superior coverage in many spraying applications.



20° pattern incline; alternate nozzles for a twin spray pattern, excellent for suspension based tank mixes.

**Metric Units**

Noz- zle Size	Droplet Size	Pressure [BAR]	Flow Rate [LPM]	Application Rate L/Ha -50 cm Spacing KM/H							
				7	8	10	12	15	20	25	30
015	-	1,5	0,42	72	63	50	42	34	25	20	17
	M	2	0,49	84	74	59	49	39	29	24	20
	M	3	0,60	103	90	72	60	48	36	29	24
	M	4	0,69	118	104	83	69	55	41	33	28
	F	5	0,77	132	116	92	77	62	46	37	31
	F	6	0,85	146	128	102	85	68	51	41	34
	F	7	0,92	158	138	110	92	74	55	44	37
	F	8	0,98	168	147	118	98	78	59	47	39
02	-	1,5	0,57	98	86	68	57	46	34	27	23
	M	2	0,65	111	98	78	65	52	39	31	26
	M	3	0,80	137	120	96	80	64	48	38	32
	M	4	0,92	158	138	110	92	74	55	44	37
	M	5	1,03	177	155	124	103	82	62	49	41
	M	6	1,13	194	170	136	113	90	68	54	45
	M	7	1,22	209	183	146	122	98	73	59	49
	F	8	1,31	225	197	157	131	105	79	63	52
025	-	1,5	0,71	122	107	85	71	57	43	34	28
	M	2	0,82	141	123	98	82	66	49	39	33
	M	3	1,00	171	150	120	100	80	60	48	40
	M	4	1,15	197	173	138	115	92	69	55	46
	M	5	1,29	221	194	155	129	103	77	62	52
	M	6	1,41	242	212	169	141	113	85	68	56
	M	7	1,53	262	230	184	153	122	92	73	61
	M	8	1,63	279	245	196	163	130	98	78	65
03	C	1,5	0,85	146	128	102	85	68	51	41	34
	M	2	0,98	168	147	118	98	78	59	47	39
	M	3	1,20	206	180	144	120	96	72	58	48
	M	4	1,39	238	209	167	139	111	83	67	56
	M	5	1,55	266	233	186	155	124	93	74	62
	M	6	1,70	291	255	204	170	136	102	82	68
	M	7	1,83	314	275	220	183	146	110	88	73
	M	8	1,96	336	294	235	196	157	118	94	78
04	VC	1,5	1,13	194	170	136	113	90	68	54	45
	VC	2	1,31	225	197	157	131	105	79	63	52
	C	3	1,60	274	240	192	160	128	96	77	64
	C	4	1,85	317	278	222	185	148	111	89	74
	M	5	2,07	355	311	248	207	166	124	99	83
	M	6	2,26	387	339	271	226	181	136	108	90
	M	7	2,44	418	366	293	244	195	146	117	98
	M	8	2,61	447	392	313	261	209	157	125	104
05	XC	1,5	1,41	242	212	169	141	113	85	68	56
	XC	2	1,63	279	245	196	163	130	98	78	65
	VC	3	2,00	343	300	240	200	160	120	96	80
	C	4	2,31	396	347	277	231	185	139	111	92
	M	5	2,58	442	387	310	258	206	155	124	103
	M	6	2,83	485	425	340	283	226	170	136	113
	M	7	3,06	525	459	367	306	245	184	147	122
	F	8	3,27	561	491	392	327	262	196	157	131
06	XC	1,5	1,70	291	255	204	170	136	102	82	68
	XC	2	1,96	336	294	235	196	157	118	94	78
	VC	3	2,40	411	360	288	240	192	144	115	96
	C	4	2,77	475	416	332	277	222	164	133	111
	M	5	3,10	531	465	372	310	248	186	149	124
	M	6	3,39	581	509	407	339	271	203	163	136
	M	7	3,67	629	551	440	367	294	220	176	147
	M	8	3,92	672	588	470	392	314	235	188	157
08	XC	1,5	2,26	387	339	271	226	181	136	108	90
	VC	2	2,61	447	392	313	261	209	157	125	104
	C	3	3,20	549	480	384	320	256	192	154	128
	M	4	3,70	634	555	444	370	296	222	178	148
	M	5	4,13	708	620	496	413	330	248	198	165
	M	6	4,53	777	680	544	453	362	272	217	181
	F	7	4,89	838	734	587	489	391	293	235	196
	F	8	5,23	897	785	628	523	418	314	251	209

Droplet size based on ASABE S572.1 standard.

Features	
Common Use	Plant Health
Pattern	Tapered Flat Fan
Technology	Pre-Orifice
Material	Polycetal
Spray Angle	120°
Pressure Range	20-115 PSI (1-8 BAR)
Configuration	FastCap Complete
Optimum Boom Height	
15" (35 cm) Spacing	13" (33 cm)
20" (50 cm) Spacing	18" (46 cm)
Part Numbers	
FastCaps® 120°	
GRD120-015	
GRD120-02	
GRD120-025	
GRD120-03	
GRD120-04	
GRD120-05	
GRD120-06	
GRD120-08	
Replacement Nozzle Strainer	
TS02-100	100 mesh strainer for size 015-03
TS02-50	50 mesh strainer for size 04-08
Replacement Cap Gasket	
22W11MF64	

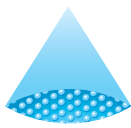

# Lo-Drift 80° & 110°



The Lo-Drift is the original drift-reducing nozzle. The special two-part construction includes a pre-orifice, which reduces the number of drift prone droplets.

- Significantly reduces spray drift, widening the operational window
- Balanced droplet size for effective, on-target spray
- Available in acid-resistant PVDF (See page 190)

## US Units

Nozzle Size	Droplet Size		Pressure (PSI)	Flow Rate (GPM)	Gallons per Acre 20 inch nozzle spacing								GAL/1000 Ft <sup>2</sup>			
	80°	110°			MPH								20 inch nozzle spacing			
					4	5	6	8	10	12	15	20	2	3	4	5
015	M	M	20	0.11	8.2	6.5	5.4	4.1	3.3	2.7	2.2	1.6	0.38	0.25	0.19	0.15
	M	M	30	0.13	9.7	7.7	6.4	4.8	3.9	3.2	2.6	1.9	0.44	0.30	0.22	0.18
	M	M	40	0.15	11.1	8.9	7.4	5.6	4.5	3.7	3.0	2.2	0.51	0.34	0.26	0.20
	M	F	50	0.17	12.6	10.1	8.4	6.3	5.0	4.2	3.4	2.5	0.58	0.39	0.29	0.23
	M	F	60	0.18	13.4	10.7	8.9	6.7	5.3	4.5	3.6	2.7	0.61	0.41	0.31	0.25
	M	F	70	0.20	14.9	11.9	9.9	7.4	5.9	5.0	4.0	3.0	0.68	0.45	0.34	0.27
02	C	M	20	0.14	10.4	8.3	6.9	5.2	4.2	3.5	2.8	2.1	0.48	0.32	0.24	0.19
	C	M	30	0.17	12.6	10.1	8.4	6.3	5.0	4.2	3.4	2.5	0.58	0.39	0.29	0.23
	M	F	40	0.20	14.9	11.9	9.9	7.4	5.9	5.0	4.0	3.0	0.68	0.45	0.34	0.27
	M	F	50	0.22	16.3	13.1	10.9	8.2	6.5	5.4	4.4	3.3	0.75	0.50	0.38	0.30
	M	F	60	0.24	17.8	14.3	11.9	8.9	7.1	5.9	4.8	3.6	0.82	0.55	0.41	0.33
	M	F	70	0.26	19.3	15.4	12.9	9.7	7.7	6.4	5.1	3.9	0.89	0.59	0.44	0.35
025	-	M	20	0.18	13.4	10.7	8.9	6.7	5.3	4.5	3.6	2.7	0.61	0.41	0.31	0.25
	-	M	30	0.22	16.3	13.1	10.9	8.2	6.5	5.4	4.4	3.3	0.75	0.50	0.38	0.30
	-	M	40	0.25	18.6	14.9	12.4	9.3	7.4	6.2	5.0	3.7	0.85	0.57	0.43	0.34
	-	M	50	0.28	20.8	16.6	13.9	10.4	8.3	6.9	5.5	4.2	0.95	0.64	0.48	0.38
	-	M	60	0.31	23.0	18.4	15.3	11.5	9.2	7.7	6.1	4.6	1.06	0.70	0.53	0.42
	-	M	70	0.33	24.5	19.6	16.3	12.3	9.8	8.2	6.5	4.9	1.13	0.75	0.56	0.45
03	C	C	20	0.21	15.6	12.5	10.4	7.8	6.2	5.2	4.2	3.1	0.72	0.48	0.36	0.29
	C	M	30	0.26	19.3	15.4	12.9	9.7	7.7	6.4	5.1	3.9	0.89	0.59	0.44	0.35
	C	M	40	0.30	22.3	17.8	14.9	11.1	8.9	7.4	5.9	4.5	1.02	0.68	0.51	0.41
	M	M	50	0.34	25.2	20.2	16.8	12.6	10.1	8.4	6.7	5.0	1.16	0.77	0.58	0.46
	M	M	60	0.37	27.5	22.0	18.3	13.7	11.0	9.2	7.3	5.5	1.26	0.84	0.63	0.50
	M	M	70	0.40	29.7	23.8	19.8	14.9	11.9	9.9	7.9	5.9	1.36	0.91	0.68	0.55
04	C	C	20	0.28	20.8	16.6	13.9	10.4	8.3	6.9	5.5	4.2	0.95	0.64	0.48	0.38
	C	M	30	0.35	26.0	20.8	17.3	13.0	10.4	8.7	6.9	5.2	1.19	0.80	0.60	0.48
	C	M	40	0.40	29.7	23.8	19.8	14.9	11.9	9.9	7.9	5.9	1.36	0.91	0.68	0.55
	M	M	50	0.45	33.4	26.7	22.3	16.7	13.4	11.1	8.9	6.7	1.53	1.02	0.77	0.61
	M	M	60	0.49	36.4	29.1	24.3	18.2	14.6	12.1	9.7	7.3	1.67	1.11	0.84	0.67
	M	M	70	0.53	39.4	31.5	26.2	19.7	15.7	13.1	10.5	7.9	1.81	1.20	0.90	0.72
05	C	C	20	0.35	26.0	20.8	17.3	13.0	10.4	8.7	6.9	5.2	1.19	0.80	0.60	0.48
	C	C	30	0.43	31.9	25.5	21.3	16.0	12.8	10.6	8.5	6.4	1.47	0.98	0.73	0.59
	C	M	40	0.50	37.1	29.7	24.8	18.6	14.9	12.4	9.9	7.4	1.71	1.14	0.85	0.68
	C	M	50	0.56	41.6	33.3	27.7	20.8	16.6	13.9	11.1	8.3	1.91	1.27	0.95	0.76
	C	M	60	0.61	45.3	36.2	30.2	22.6	18.1	15.1	12.1	9.1	2.08	1.39	1.04	0.83
	M	F	70	0.66	49.0	39.2	32.7	24.5	19.6	16.3	13.1	9.8	2.25	1.50	1.13	0.90
06	VC	VC	20	0.42	31.2	24.9	20.8	15.6	12.5	10.4	8.3	6.2	1.43	0.95	0.72	0.57
	VC	C	30	0.52	38.6	30.9	25.7	19.3	15.4	12.9	10.3	7.7	1.77	1.18	0.89	0.71
	C	M	40	0.60	44.6	35.6	29.7	22.3	17.8	14.9	11.9	8.9	2.05	1.36	1.02	0.82
	C	M	50	0.67	49.7	39.8	33.2	24.9	19.9	16.6	13.3	9.9	2.28	1.52	1.14	0.91
	C	M	60	0.73	54.2	43.4	36.1	27.1	21.7	18.1	14.5	10.8	2.49	1.66	1.24	1.00
	C	M	70	0.79	58.7	46.9	39.1	29.3	23.5	19.6	15.6	11.7	2.69	1.80	1.35	1.08
08	XC	VC	20	0.57	42.3	33.9	28.2	21.2	16.9	14.1	11.3	8.5	1.94	1.30	0.97	0.78
	VC	C	30	0.69	51.2	41.0	34.2	25.6	20.5	17.1	13.7	10.2	2.35	1.57	1.18	0.94
	VC	C	40	0.80	59.4	47.5	39.6	29.7	23.8	19.8	15.8	11.9	2.73	1.82	1.36	1.09
	C	M	50	0.89	66.1	52.9	44.1	33.0	26.4	22.0	17.6	13.2	3.03	2.02	1.52	1.21
	C	M	60	0.98	72.8	58.2	48.5	36.4	29.1	24.3	19.4	14.6	3.34	2.23	1.67	1.34
	C	M	70	1.06	78.7	63.0	52.5	39.4	31.5	26.2	21.0	15.7	3.61	2.41	1.81	1.45

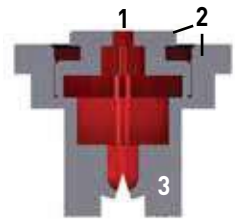

1. Non-Air Inducted; Pre-orifice design for excellent performance with suspension solutions
2. Dual component construction
3. Material: Polyacetal or PVDF

Droplet size based on ASABE S572.1 standard.



110° wide, drift reducing design that is excellent for suspension based tank mixes.



Pre-orifice design limits the formation of small droplets; reducing drift potential with a medium droplet spectrum.



See [www.hyprospraytips.com/certifications](http://www.hyprospraytips.com/certifications) for the latest drift reduction standard information.

### Metric Units

Nozzle Size	ASABE Droplet Size		Pressure (BAR)	Flow Rate (LPM)	Application Rate L/Ha - 50 cm spacing KM/H						Drift Reduction Standards		
	80°	110°			7	8	10	12	15	20		25	30
015	M	M	2	0,49	84	74	59	49	39	29	24	20	LERAP
	M	M	3	0,60	103	90	72	60	48	36	29	24	
	M	F	4	0,69	118	104	83	69	55	41	33	28	
	C	M	2	0,65	111	98	78	65	52	39	31	26	
02	M	F	3	0,80	137	120	96	80	64	48	38	32	
	M	F	4	0,92	158	138	110	92	74	55	44	37	
	-	M	2	0,82	141	123	98	82	66	49	39	33	
025	-	M	3	1,00	171	150	120	100	80	60	48	40	
	-	M	4	1,15	197	173	138	115	92	69	55	46	
	C	M	2	0,98	168	147	118	98	78	59	47	39	
03	C	M	3	1,20	206	180	144	120	96	72	58	48	
	C	M	4	1,39	238	209	167	139	111	83	67	56	
	C	M	2	1,31	225	197	157	131	105	79	63	52	
04	C	M	3	1,60	274	240	192	160	128	96	77	64	
	C	M	4	1,85	317	278	222	185	148	111	89	74	
	C	M	2	1,63	279	245	196	163	130	98	78	65	
05	C	M	3	2,00	343	300	240	200	160	120	96	80	
	C	M	4	2,31	396	347	277	231	185	139	111	92	
	C	M	2	1,96	336	294	235	196	157	118	94	78	
06	VC	C	3	2,40	411	360	288	240	192	144	115	96	75% + 2.0-3.0 BAR
	C	M	4	2,77	475	416	332	277	222	166	133	111	
	C	M	2	2,61	447	392	313	261	209	157	125	104	
08	VC	C	3	3,20	549	480	384	320	256	192	154	128	
	VC	C	4	3,70	634	555	444	370	296	222	178	148	
	C	M	2	3,00	500	440	352	296	232	176	140	112	

Droplet size based on ASABE S572.1 standard.

Features	
Common Use	Plant Health
Pattern	Tapered Flat Fan
Technology	Pre-Orifice
Material	Polyacetal
Spray Angle	80° & 110°
Pressure Range	20-70 PSI (1-5 BAR)
Configuration	Nozzles, FastCap
Optimum Boom Height	
80° - 15" (35 cm) Spacing	22" (56 cm)
80° - 20" (50 cm) Spacing	30" (76 cm)
110° - 15" (35 cm) Spacing	15" (35 cm)
110° - 20" (50 cm) Spacing	20" (50 cm)
Part Numbers	
Nozzles 80°	Caps (25 Packs)
LD80-015	CAP00-015
LD80-02	CAP00-02
LD80-03	CAP00-03
LD80-04	CAP00-04
LD80-05	CAP00-05
LD80-06	CAP00-06
LD80-08	CAP00-08
Nozzles 110°	Caps (25 Packs)
LD110-015	CAP00-015
LD110-02	CAP00-02
LD110-025*	CAP00-025
LD110-03	CAP00-03
LD110-04*	CAP00-04
LD110-05*	CAP00-05
LD110-06*	CAP00-06
LD110-08	CAP00-08

\*Approved by JKI

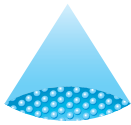

# Ceramic ADI 110<sup>o</sup>



The Albuz<sup>®</sup> ADI anti-drift spray nozzle provides a versatile balance of drift reduction and target coverage. The proven pre-orifice design creates droplets that are well suited for a wide range of spray applications. The ceramic orifice resists wear better than other materials and will provide acre after acre of service.

- Droplet size balances drift reduction and target coverage
- Simple and effective pre-orifice design
- Versatile and long-lasting nozzle

## US Units

Nozzle Size	Droplet Size	Pressure (PSI)	Flow Rate (GPM)	Gallons per Acre 20 inch nozzle spacing MPH										GAL/1000 <sup>ft</sup> <sup>2</sup> 20 inch nozzle spacing			
				4	5	6	8	10	12	15	20	2	3	4	5		
01	M	30	0.09	6.7	5.3	4.5	3.3	2.7	2.2	1.8	1.3	0.31	0.20	0.15	0.12		
	M	40	0.10	7.4	5.9	5.0	3.7	3.0	2.5	2.0	1.5	0.34	0.23	0.17	0.14		
	F	50	0.11	8.2	6.5	5.4	4.1	3.3	2.7	2.2	1.6	0.38	0.25	0.19	0.15		
	F	60	0.12	8.9	7.1	5.9	4.5	3.6	3.0	2.4	1.8	0.41	0.27	0.20	0.16		
015	F	70	0.13	9.7	7.7	6.4	4.8	3.9	3.2	2.6	1.9	0.44	0.30	0.22	0.18		
	M	30	0.13	9.7	7.7	6.4	4.8	3.9	3.2	2.6	1.9	0.44	0.30	0.22	0.18		
	M	40	0.15	11.1	8.9	7.4	5.6	4.5	3.7	3.0	2.2	0.51	0.34	0.26	0.20		
	M	50	0.17	12.6	10.1	8.4	6.3	5.0	4.2	3.4	2.5	0.58	0.39	0.29	0.23		
02	M	60	0.18	13.4	10.7	8.9	6.7	5.3	4.5	3.6	2.7	0.61	0.41	0.31	0.25		
	M	70	0.20	14.9	11.9	9.9	7.4	5.9	5.0	4.0	3.0	0.68	0.45	0.34	0.27		
	M	30	0.17	12.6	10.1	8.4	6.3	5.0	4.2	3.4	2.5	0.58	0.39	0.29	0.23		
	M	40	0.20	14.9	11.9	9.9	7.4	5.9	5.0	4.0	3.0	0.68	0.45	0.34	0.27		
03	M	50	0.22	16.3	13.1	10.9	8.2	6.5	5.4	4.4	3.3	0.75	0.50	0.38	0.30		
	M	60	0.24	17.8	14.3	11.9	8.9	7.1	5.9	4.8	3.6	0.82	0.55	0.41	0.33		
	M	70	0.26	19.3	15.4	12.9	9.7	7.7	6.4	5.1	3.9	0.89	0.59	0.44	0.35		
	C	30	0.26	19.3	15.4	12.9	9.7	7.7	6.4	5.1	3.9	0.89	0.59	0.44	0.35		
04	M	40	0.30	22.3	17.8	14.9	11.1	8.9	7.4	5.9	4.5	1.02	0.68	0.51	0.41		
	M	50	0.34	25.2	20.2	16.8	12.6	10.1	8.4	6.7	5.0	1.16	0.77	0.58	0.46		
	M	60	0.37	27.5	22.0	18.3	13.7	11.0	9.2	7.3	5.5	1.26	0.84	0.63	0.50		
	M	70	0.40	29.7	23.8	19.8	14.9	11.9	9.9	7.9	5.9	1.36	0.91	0.68	0.55		
04	VC	30	0.35	26.0	20.8	17.3	13.0	10.4	8.7	6.9	5.2	1.19	0.80	0.60	0.48		
	C	40	0.40	29.7	23.8	19.8	14.9	11.9	9.9	7.9	5.9	1.36	0.91	0.68	0.55		
	C	50	0.45	33.4	26.7	22.3	16.7	13.4	11.1	8.9	6.7	1.53	1.02	0.77	0.61		
	M	60	0.49	36.4	29.1	24.3	18.2	14.6	12.1	9.7	7.3	1.67	1.11	0.84	0.67		
04	M	70	0.53	39.4	31.5	26.2	19.7	15.7	13.1	10.5	7.9	1.81	1.20	0.90	0.72		

Droplet size based on ASABE S572.1 standard.

## Metric Units

Nozzle Size	Droplet Size	Pressure (PSI)	Flow Rate (L/min)	Gallons per Acre 20 inch nozzle spacing MPH									
				6	8	10	12	14	16	18	20	25	30
01	F	2	0.33	87	65	52	43	37	33	29	26	21	17
	F	3	0.40	105	79	63	53	45	39	35	32	25	21
	F	4	0.46	121	91	73	61	52	45	40	36	29	24
	VF	5	0.52	137	103	82	68	59	51	46	41	33	27
02	F	2	0.49	129	97	77	64	55	48	43	39	31	26
	F	3	0.60	158	118	95	79	68	59	53	47	38	32
	F	4	0.69	182	136	109	91	78	68	61	54	44	36
	F	5	0.77	203	152	122	101	87	76	68	61	49	41
03	M	2	0.65	171	128	103	86	73	64	57	51	41	34
	M	3	0.80	211	158	126	105	90	79	70	63	51	42
	F	4	0.92	242	182	145	121	104	91	81	73	58	48
	F	5	1.03	271	203	163	136	116	102	90	81	65	54
04	M	2	0.98	258	193	155	129	111	97	86	77	62	52
	M	3	1.20	316	237	189	158	135	118	105	95	76	63
	M	4	1.39	366	274	219	183	157	137	122	110	88	73
	F	5	1.55	408	306	245	204	175	153	136	122	98	82
05	M	2	1.31	345	259	207	172	148	129	115	103	83	69
	M	3	1.60	421	316	253	211	180	158	140	126	101	84
	M	4	1.85	487	365	292	243	209	183	162	146	117	97
	M	5	2.07	545	409	327	272	233	204	182	163	131	109
06	M	2	1.96	516	387	309	258	221	193	172	155	124	103
	M	3	2.40	632	474	379	316	271	237	211	189	152	126
	M	4	2.77	729	547	437	364	312	273	243	219	175	146
	M	5	3.10	816	612	489	408	350	306	272	245	196	163

Droplet size based on ASABE S572.1 standard.

Features	
Common Use	Plant Health
Pattern	Tapered Flat Fan
Technology	Air Induction
Material	Ceramic
	110°
Pressure Range	30-70 PSI (2-5 BAR)
Configuration	Nozzles
Optimum Boom Height	
15" (35 cm) Spacing	15" (35 cm)
20" (50 cm) Spacing	20" (50 cm)
Part Numbers	
Nozzles 110°	Caps (25 Pack)
ADI-11001	CAP00-01
ADI-110015	CAP00-015
ADI-11002	CAP00-02
ADI-11003	CAP00-03
ADI-11004	CAP00-04

# SprayIT Mobile App

## Select the right nozzle sized for your application

- Choose 'Select by Application' for a full list of nozzles that fit your application requirements
- Choose 'Select by Chemical' (US only) for a recommended nozzle family based on the chemical you are using
- Search for a specific nozzle or chemical directly from the home screen
- Integrated Where to Buy tool makes purchasing easy
- Available in US and Metric Units and multiple languages



Search 'SprayIT' on the Apple Store or Android Market



# SprayIT Online Calculator

The SprayIT Calculator is an easy-to-use tool that will help you find the right spray nozzle for your desired application. Simply answer a few questions about your specific application and we'll supply you the best nozzles for that application.

This tool is available on the Hypro website or as a mobile app available for both Apple and Android devices.

[sprayit.hyprospraytips.com](http://sprayit.hyprospraytips.com)





# Variable Pressure 80° & 110°

Variable Pressure nozzle maintain a consistent spray angle over a wide pressure range down to 20 PSI (1 BAR) and are available in 80° and 110° versions to work with different boom heights.



- Adjustable droplet size according to pressure
- Maintains good spray distribution and makes larger droplets at low pressures
- FastCap includes nozzle, cap and gasket
- Excellent nozzle for a wide variety of herbicide and insecticide applications

## US Units

Nozzle Size	Droplet Size		Pressure (PSI)	Flow Rate (GPM)	Gallons per Acre 20 inch nozzle spacing										GAL/1000 <sup>ft</sup>				
	80°	110°			MPH										20 inch nozzle spacing				
						4	5	6	8	10	12	15	20	2	3	4	5		
015	-	-	20	0.11	8.2	6.5	5.4	4.1	3.3	2.7	2.2	1.6	0.38	0.25	0.19	0.15			
	F	F	30	0.13	9.7	7.7	6.4	4.8	3.9	3.2	2.6	1.9	0.44	0.30	0.22	0.18			
	F	F	40	0.15	11.1	8.9	7.4	5.6	4.5	3.7	3.0	2.2	0.51	0.34	0.24	0.20			
	F	F	50	0.17	12.6	10.1	8.4	6.3	5.0	4.2	3.4	2.5	0.58	0.39	0.29	0.23			
	F	F	60	0.18	13.4	10.7	8.9	6.7	5.3	4.5	3.6	2.7	0.61	0.41	0.31	0.25			
	VF	VF	70	0.20	14.9	11.9	9.9	7.4	5.9	5.0	4.0	3.0	0.68	0.45	0.34	0.27			
02	-	-	20	0.14	10.4	8.3	6.9	5.2	4.2	3.5	2.8	2.1	0.48	0.32	0.24	0.19			
	F	F	30	0.17	12.6	10.1	8.4	6.3	5.0	4.2	3.4	2.5	0.58	0.39	0.29	0.23			
	F	F	40	0.20	14.9	11.9	9.9	7.4	5.9	5.0	4.0	3.0	0.68	0.45	0.34	0.27			
	F	F	50	0.22	16.3	13.1	10.9	8.2	6.5	5.4	4.4	3.3	0.75	0.50	0.38	0.30			
	F	F	60	0.24	17.8	14.3	11.9	8.9	7.1	5.9	4.8	3.6	0.82	0.55	0.41	0.33			
	F	F	70	0.26	19.3	15.4	12.9	9.7	7.7	6.4	5.1	3.9	0.89	0.59	0.44	0.35			
025	-	M	20	0.18	13.4	10.7	8.9	6.7	5.3	4.5	3.6	2.7	0.61	0.41	0.31	0.25			
	-	F	30	0.22	16.3	13.1	10.9	8.2	6.5	5.4	4.4	3.3	0.75	0.50	0.38	0.30			
	-	F	40	0.25	18.6	14.9	12.4	9.3	7.4	6.2	5.0	3.7	0.85	0.57	0.43	0.34			
	-	F	50	0.28	20.8	16.6	13.9	10.4	8.3	6.9	5.5	4.2	0.95	0.64	0.48	0.38			
	-	F	60	0.31	23.0	18.4	15.3	11.5	9.2	7.7	6.1	4.6	1.06	0.70	0.53	0.42			
	-	F	70	0.33	24.5	19.6	16.3	12.3	9.8	8.2	6.5	4.9	1.13	0.75	0.56	0.45			
03	M	M	20	0.21	15.6	12.5	10.4	7.8	6.2	5.2	4.2	3.1	0.72	0.48	0.36	0.29			
	F	F	30	0.26	19.3	15.4	12.9	9.7	7.7	6.4	5.1	3.9	0.89	0.59	0.44	0.35			
	F	F	40	0.30	22.3	17.8	14.9	11.1	8.9	7.4	5.9	4.5	1.02	0.68	0.51	0.41			
	F	F	50	0.34	25.2	20.2	16.8	12.6	10.1	8.4	6.7	5.0	1.16	0.77	0.58	0.46			
	F	F	60	0.37	27.5	22.0	18.3	13.7	11.0	9.2	7.3	5.5	1.26	0.84	0.63	0.50			
	F	F	70	0.40	29.7	23.8	19.8	14.9	11.9	9.9	7.9	5.9	1.36	0.91	0.68	0.55			
035	-	M	20	0.25	18.6	14.9	12.4	9.3	7.4	6.2	5.0	3.7	0.85	0.57	0.43	0.34			
	-	F	30	0.30	22.3	17.8	14.9	11.1	8.9	7.4	5.9	4.5	1.02	0.68	0.51	0.41			
	-	F	40	0.35	26.0	20.8	17.3	13.0	10.4	8.7	6.9	5.2	1.19	0.80	0.60	0.48			
	-	F	50	0.39	29.0	23.2	19.3	14.5	11.6	9.7	7.7	5.8	1.33	0.89	0.66	0.53			
	-	F	60	0.43	31.9	25.5	21.3	16.0	12.8	10.6	8.5	6.4	1.47	0.98	0.73	0.59			
	-	F	70	0.46	34.2	27.3	22.8	17.1	13.7	11.4	9.1	6.8	1.57	1.05	0.78	0.63			
04	C	M	20	0.28	20.8	16.6	13.9	10.4	8.3	6.9	5.5	4.2	0.95	0.64	0.48	0.38			
	M	F	30	0.35	26.0	20.8	17.3	13.0	10.4	8.7	6.9	5.2	1.19	0.80	0.60	0.48			
	F	F	40	0.40	29.7	23.8	19.8	14.9	11.9	9.9	7.9	5.9	1.36	0.91	0.68	0.55			
	F	F	50	0.45	33.4	26.7	22.3	16.7	13.4	11.1	8.9	6.7	1.53	1.02	0.77	0.61			
	F	F	60	0.49	36.4	29.1	24.3	18.2	14.6	12.1	9.7	7.3	1.67	1.11	0.84	0.67			
	F	F	70	0.53	39.4	31.5	26.2	19.7	15.7	13.1	10.5	7.9	1.81	1.20	0.90	0.72			
05	C	M	20	0.35	26.0	20.8	17.3	13.0	10.4	8.7	6.9	5.2	1.19	0.80	0.60	0.48			
	C	F	30	0.43	31.9	25.5	21.3	16.0	12.8	10.6	8.5	6.4	1.47	0.98	0.73	0.59			
	M	F	40	0.50	37.1	29.7	24.8	18.6	14.9	12.4	9.9	7.4	1.71	1.14	0.85	0.68			
	M	F	50	0.56	41.6	33.3	27.7	20.8	16.6	13.9	11.1	8.3	1.91	1.27	0.95	0.76			
	M	F	60	0.61	45.3	36.2	30.2	22.6	18.1	15.1	12.1	9.1	2.08	1.39	1.04	0.83			
	M	F	70	0.66	49.0	39.2	32.7	24.5	19.6	16.3	13.1	9.8	2.25	1.50	1.13	0.90			
06	C	M	20	0.42	31.2	24.9	20.8	15.6	12.5	10.4	8.3	6.2	1.43	0.95	0.72	0.57			
	C	F	30	0.52	38.6	30.9	25.7	19.3	15.4	12.9	10.3	7.7	1.77	1.18	0.89	0.71			
	M	F	40	0.60	44.6	35.6	29.7	22.3	17.8	14.9	11.9	8.9	2.05	1.36	1.02	0.82			
	M	F	50	0.67	49.7	39.8	33.2	24.9	19.9	16.6	13.3	9.9	2.28	1.52	1.14	0.91			
	M	F	60	0.73	54.2	43.4	36.1	27.1	21.7	18.1	14.5	10.8	2.49	1.66	1.24	1.00			
	M	F	70	0.79	58.7	46.9	39.1	29.3	23.5	19.6	15.6	11.7	2.69	1.80	1.35	1.08			
08	-	C	20	0.57	42.3	33.9	28.2	21.2	16.9	14.1	11.3	8.5	1.94	1.30	0.97	0.78			
	-	M	30	0.69	51.2	41.0	34.2	25.6	20.5	17.1	13.7	10.2	2.35	1.57	1.18	0.94			
	-	M	40	0.80	59.4	47.5	39.6	29.7	23.8	19.8	15.8	11.9	2.73	1.82	1.36	1.09			
	-	M	50	0.89	66.1	52.9	44.1	33.0	26.4	22.0	17.6	13.2	3.03	2.02	1.52	1.21			
	-	M	60	0.98	72.8	58.2	48.5	36.4	29.1	24.3	19.4	14.6	3.34	2.23	1.67	1.34			
	-	F	70	1.06	78.7	63.0	52.5	39.4	31.5	26.2	21.0	15.7	3.61	2.41	1.81	1.45			
10	-	C	20	0.71	52.7	42.2	35.1	26.4	21.1	17.6	14.1	10.5	2.42	1.61	1.21	0.97			
	-	M	30	0.87	64.6	51.7	43.1	32.3	25.8	21.5	17.2	12.9	2.97	1.98	1.48	1.19			
	-	M	40	1.00	74.3	59.4	49.5	37.1	29.7	24.8	19.8	14.9	3.41	2.27	1.71	1.36			
	-	M	50	1.12	83.2	66.5	55.4	41.6	33.3	27.7	22.2	16.6	3.82	2.55	1.91	1.53			
	-	M	60	1.22	90.6	72.5	60.4	45.3	36.2	30.2	24.2	18.1	4.16	2.77	2.08	1.66			
	-	F	70	1.32	98.0	78.4	65.3	49.0	39.2	32.7	26.1	19.6	4.50	3.00	2.25	1.80			
15	-	C	20	1.06	78.7	63.0	52.5	39.4	31.5	26.2	21.0	15.7	3.61	2.41	1.81	1.45			
	-	M	30	1.30	96.5	77.2	64.4	48.3	38.6	32.2	25.7	19.3	4.43	2.96	2.22	1.77			
	-	M	40	1.50	111	89.1	74.3	55.7	44.6	37.1	29.7	22.3	5.12	3.41	2.56	2.05			
	-	M	50	1.68	125	99.8	83.2	62.4	49.9	41.6	33.3	24.9	5.73	3.82	2.86	2.29			
	-	M	60	1.84	137	109	91.1	68.3	54.6	45.5	36.4	27.3	6.27	4.18	3.14	2.51			
	-	M	70	1.98	147	118	98.0	73.5	58.8	49.0	39.2	29.4	6.75	4.50	3.38	2.70			

Droplet size based on ASABE S572.1 standard.

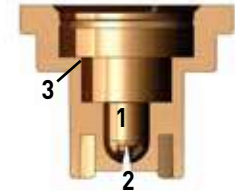

1. Non-Air Inducted; single inlet/outlet design
2. Fully formed spray pattern at low pressures
3. Enhanced polyacetal for superior product life



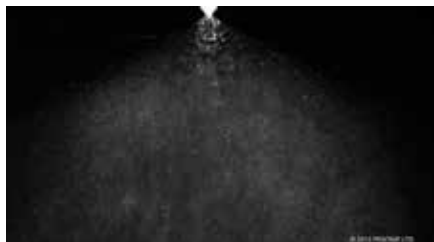

Low pressure performance allows for complete pattern formation and even coverage down to 15 psi (1 BAR).



Dense spray pattern of medium to fine droplets provides superior coverage.

### Metric Units

Nozzle Size	ASEBE Droplet Size		Pressure (BAR)	Flow Rate (LPM)	Application Rate L/Ha - 50 cm spacing KM/H							
	80°	110°			7	8	10	12	15	20	25	30
015	-	-	1	0,35	60	53	42	35	28	21	17	14
	-	-	1,5	0,42	72	63	50	42	34	25	20	17
	F	F	2	0,49	84	74	59	49	39	29	24	20
	F	F	3	0,60	103	90	72	60	48	36	29	24
	VF	VF	4	0,69	118	104	83	69	55	41	33	28
02	-	-	1	0,46	79	69	55	46	37	28	22	18
	-	-	1,5	0,57	98	86	68	57	46	34	27	23
	F	F	2	0,65	111	98	78	65	52	39	31	26
	F	F	3	0,80	137	120	96	80	64	48	38	32
	F	F	4	0,92	158	138	110	92	74	55	44	37
025	-	-	1	0,58	99	87	70	58	46	35	28	23
	-	M	1,5	0,71	122	107	85	71	57	43	34	28
	-	F	2	0,82	141	123	98	82	66	49	39	33
	-	F	3	1,00	171	150	120	100	80	60	48	40
	-	F	4	1,15	197	173	138	115	92	69	55	46
03	-	F	1	0,69	118	104	83	69	55	41	33	28
	C	M	1,5	0,85	146	128	102	85	68	51	41	34
	M	F	2	0,98	168	147	118	98	78	59	47	39
	F	F	3	1,20	206	180	144	120	96	72	58	48
	F	F	4	1,39	238	209	167	139	111	83	67	56
035	-	M	1	0,81	139	122	97	81	65	49	39	32
	-	M	1,5	0,99	170	149	119	99	79	59	48	40
	-	M	2	1,14	195	171	137	114	91	68	55	46
	-	F	3	1,40	240	210	168	140	112	84	67	56
	-	F	4	1,62	278	243	194	162	130	97	78	65
04	-	F	1	0,92	158	138	110	92	74	55	44	37
	C	M	1,5	1,13	194	170	136	113	90	68	54	45
	M	M	2	1,31	225	197	157	131	105	79	63	52
	M	F	3	1,60	274	240	192	160	128	96	77	64
	F	F	4	1,85	317	278	222	185	148	111	89	74
05	-	F	1	0,92	158	138	110	92	74	55	44	37
	C	M	1,5	1,13	194	170	136	113	90	68	54	45
	M	M	2	1,31	225	197	157	131	105	79	63	52
	M	F	3	1,60	274	240	192	160	128	96	77	64
	F	F	4	1,85	317	278	222	185	148	111	89	74
06	-	F	1	0,92	158	138	110	92	74	55	44	37
	C	M	1,5	1,13	194	170	136	113	90	68	54	45
	M	M	2	1,31	225	197	157	131	105	79	63	52
	M	F	3	1,60	274	240	192	160	128	96	77	64
	F	F	4	1,85	317	278	222	185	148	111	89	74
08	-	F	1	1,15	197	173	138	115	92	69	55	46
	C	M	1,5	1,41	242	212	169	141	113	85	68	56
	C	M	2	1,63	279	245	196	163	130	98	78	65
	M	F	3	2,00	343	300	240	200	160	120	96	80
	M	F	4	2,31	396	347	277	231	185	139	111	92
10	-	F	1	1,39	238	209	167	139	111	83	67	56
	C	M	1,5	1,70	291	255	204	170	136	102	82	68
	C	M	2	1,96	336	294	235	196	157	118	94	78
	M	F	3	2,40	411	360	288	240	192	144	115	96
	M	F	4	2,77	475	416	332	277	222	166	133	111
15	-	F	1	1,85	317	278	222	185	148	111	89	74
	-	C	1,5	2,26	387	339	271	226	181	136	108	90
	-	M	2	2,61	447	392	313	261	209	157	125	104
	-	M	3	3,20	549	480	384	320	256	192	154	128
	-	F	4	3,70	634	555	444	370	296	222	178	148

Droplet size based on ASABE S572.1 standard.

Features	
Common Use	General
Pattern	Tapered Flat Fan
Technology	Elliptical Orifice
Material	Polycetal
Spray Angle	80° & 110°
Pressure Range	20-70 PSI (1-5 BAR)
Configuration	Nozzles, FastCap
Optimum Boom Height	
80° - 15" (35 cm) Spacing	22" (56 cm)
80° - 20" (50 cm) Spacing	30" (76 cm)
110° - 15" (35 cm) Spacing	15" (35 cm)
110° - 20" (50 cm) Spacing	20" (50 cm)
Part Numbers	
Nozzles 80°	FastCaps 80°
VP80-015	FC-VP80-015
VP80-02	FC-VP80-02
VP80-03	FC-VP80-03
VP80-04	FC-VP80-04
VP80-05	FC-VP80-05
VP80-06	FC-VP80-06
Nozzles 110°	FastCaps 110°
VP110-015	FC-VP110-015
VP110-02	FC-VP110-02
VP110-025	FC-VP110-025
VP110-03*	FC-VP110-03
VP110-035	FC-VP110-035
VP110-04*	FC-VP110-04
VP110-05*	FC-VP110-05
VP110-06	FC-VP110-06
VP110-08	FC-VP110-08
VP110-10	FC-VP110-10
VP110-15	FC-VP110-15
Replacement Cap Gasket	
22W11MF64	

\*Approved by JKI

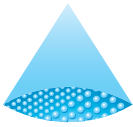

# Total Range 80° & 110°



The TR (Total Range) nozzle series consists of a metal insert that is held in a plastic carrier. The nozzles are able to maintain a constant spray angle over a wide pressure range down to 20 psi (1 bar).

- Adjustable droplet size according to pressure
- Insert is precision-machined stainless steel and carrier is molded in tough and durable polyacetal
- Maintains good spray distribution and makes larger droplets at low pressures
- FastCap includes nozzle, cap and gasket
- Excellent nozzle for insecticide and fungicide applications

## US Units

Nozzle Size	Droplet Size		Pressure (PSI)	Flow Rate (GPM)	Gallons per Acre 20 inch nozzle spacing MPH							GAL/1000 Ft <sup>2</sup> 20 inch nozzle spacing				
	80°	110°			4	5	6	8	10	12	15	20	2	3	4	5
01	F	F	20	0.07	5.2	4.2	3.5	2.6	2.1	1.7	1.4	1.0	0.24	0.16	0.12	0.10
	F	F	30	0.09	6.7	5.3	4.5	3.3	2.7	2.2	1.8	1.3	0.31	0.20	0.15	0.12
	VF	VF	40	0.10	7.4	5.9	5.0	3.7	3.0	2.5	2.0	1.5	0.34	0.23	0.17	0.14
	VF	VF	50	0.11	8.2	6.5	5.4	4.1	3.3	2.7	2.2	1.6	0.38	0.25	0.19	0.15
	VF	VF	60	0.12	8.9	7.1	5.9	4.5	3.6	3.0	2.4	1.8	0.41	0.27	0.20	0.16
	VF	VF	70	0.13	9.7	7.7	6.4	4.8	3.9	3.2	2.6	1.9	0.44	0.30	0.22	0.18
015	F	F	20	0.11	8.2	6.5	5.4	4.1	3.3	2.7	2.2	1.6	0.38	0.25	0.19	0.15
	F	F	30	0.13	9.7	7.7	6.4	4.8	3.9	3.2	2.6	1.9	0.44	0.30	0.22	0.18
	F	F	40	0.15	11.1	8.9	7.4	5.6	4.5	3.7	3.0	2.2	0.51	0.34	0.26	0.20
	F	F	50	0.17	12.6	10.1	8.4	6.3	5.0	4.2	3.4	2.5	0.58	0.39	0.29	0.23
	VF	VF	60	0.18	13.4	10.7	8.9	6.7	5.3	4.5	3.6	2.7	0.61	0.41	0.31	0.25
	VF	VF	70	0.20	14.9	11.9	9.9	7.4	5.9	5.0	4.0	3.0	0.68	0.45	0.34	0.27
02	M	M	20	0.14	10.4	8.3	6.9	5.2	4.2	3.5	2.8	2.1	0.48	0.32	0.24	0.19
	F	F	30	0.17	12.6	10.1	8.4	6.3	5.0	4.2	3.4	2.5	0.58	0.39	0.29	0.23
	F	F	40	0.20	14.9	11.9	9.9	7.4	5.9	5.0	4.0	3.0	0.68	0.45	0.34	0.27
	F	F	50	0.22	16.3	13.1	10.9	8.2	6.5	5.4	4.4	3.3	0.75	0.50	0.38	0.30
	VF	VF	60	0.24	17.8	14.3	11.9	8.9	7.1	5.9	4.8	3.6	0.82	0.55	0.41	0.33
	VF	VF	70	0.26	19.3	15.4	12.9	9.7	7.7	6.4	5.1	3.9	0.89	0.59	0.44	0.35
03	M	M	20	0.21	15.6	12.5	10.4	7.8	6.2	5.2	4.2	3.1	0.72	0.48	0.36	0.29
	F	M	30	0.26	19.3	15.4	12.9	9.7	7.7	6.4	5.1	3.9	0.89	0.59	0.44	0.35
	F	F	40	0.30	22.3	17.8	14.9	11.1	8.9	7.4	5.9	4.5	1.02	0.68	0.51	0.41
	F	F	50	0.34	25.2	20.2	16.8	12.6	10.1	8.4	6.7	5.0	1.16	0.77	0.58	0.46
	F	F	60	0.37	27.5	22.0	18.3	13.7	11.0	9.2	7.3	5.5	1.26	0.84	0.63	0.50
	F	F	70	0.40	29.7	23.8	19.8	14.9	11.9	9.9	7.9	5.9	1.36	0.91	0.68	0.55
04	C	F	20	0.28	20.8	16.6	13.9	10.4	8.3	6.9	5.5	4.2	0.95	0.64	0.48	0.38
	M	M	30	0.35	26.0	20.8	17.3	13.0	10.4	8.7	6.9	5.2	1.19	0.80	0.60	0.48
	M	F	40	0.40	29.7	23.8	19.8	14.9	11.9	9.9	7.9	5.9	1.36	0.91	0.68	0.55
	M	F	50	0.45	33.4	26.7	22.3	16.7	13.4	11.1	8.9	6.7	1.53	1.02	0.77	0.61
	F	F	60	0.49	36.4	29.1	24.3	18.2	14.6	12.1	9.7	7.3	1.67	1.11	0.84	0.67
	F	F	70	0.53	39.4	31.5	26.2	19.7	15.7	13.1	10.5	7.9	1.81	1.20	0.90	0.72
05	C	C	20	0.35	26.0	20.8	17.3	13.0	10.4	8.7	6.9	5.2	1.19	0.80	0.60	0.48
	M	M	30	0.43	31.9	25.5	21.3	16.0	12.8	10.6	8.5	6.4	1.47	0.98	0.73	0.59
	M	F	40	0.50	37.1	29.7	24.8	18.6	14.9	12.4	9.9	7.4	1.71	1.14	0.85	0.68
	M	F	50	0.56	41.6	33.3	27.7	20.8	16.6	13.9	11.1	8.3	1.91	1.27	0.95	0.76
	F	F	60	0.61	45.3	36.2	30.2	22.6	18.1	15.1	12.1	9.1	2.08	1.39	1.04	0.83
	F	F	70	0.66	49.0	39.2	32.7	24.5	19.6	16.3	13.1	9.8	2.25	1.50	1.13	0.90
06	C	C	20	0.42	31.2	24.9	20.8	15.6	12.5	10.4	8.3	6.2	1.43	0.95	0.72	0.57
	C	C	30	0.52	38.6	30.9	25.7	19.3	15.4	12.9	10.3	7.7	1.77	1.18	0.89	0.71
	M	M	40	0.60	44.6	35.6	29.7	22.3	17.8	14.9	11.9	8.9	2.05	1.36	1.02	0.82
	M	M	50	0.67	49.7	39.8	33.2	24.9	19.9	16.6	13.3	9.9	2.28	1.52	1.14	0.91
	M	F	60	0.73	54.2	43.4	36.1	27.1	21.7	18.1	14.5	10.8	2.49	1.66	1.24	1.00
	M	F	70	0.79	58.7	46.9	39.1	29.3	23.5	19.6	15.6	11.7	2.69	1.80	1.35	1.08
08	C	C	20	0.57	42.3	33.9	28.2	21.2	16.9	14.1	11.3	8.5	1.94	1.30	0.97	0.78
	C	C	30	0.69	51.2	41.0	34.2	25.6	20.5	17.1	13.7	10.2	2.35	1.57	1.18	0.94
	C	M	40	0.80	59.4	47.5	39.6	29.7	23.8	19.8	15.8	11.9	2.73	1.82	1.36	1.09
	C	M	50	0.89	66.1	52.9	44.1	33.0	26.4	22.0	17.6	13.2	3.03	2.02	1.52	1.21
	M	M	60	0.98	72.8	58.2	48.5	36.4	29.1	24.3	19.4	14.6	3.34	2.23	1.67	1.34
	M	M	70	1.06	78.7	63.0	52.5	39.4	31.5	26.2	21.0	15.7	3.61	2.41	1.81	1.45
10	VC	VC	20	0.71	52.7	42.2	35.1	26.4	21.1	17.6	14.1	10.5	2.42	1.61	1.21	0.97
	VC	C	30	0.87	64.6	51.7	43.1	32.3	25.8	21.5	17.2	12.9	2.97	1.98	1.48	1.19
	C	M	40	1.00	74.3	59.4	49.5	37.1	29.7	24.8	19.8	14.9	3.41	2.27	1.71	1.36
	C	M	50	1.12	83.2	66.5	55.4	41.6	33.3	27.7	22.2	16.6	3.82	2.55	1.91	1.53
	C	M	60	1.22	90.6	72.5	60.4	45.3	36.2	30.2	24.2	18.1	4.16	2.77	2.08	1.66
	M	M	70	1.32	98.0	78.4	65.3	49.0	39.2	32.7	26.1	19.6	4.50	3.00	2.25	1.80
15	VC	VC	20	1.06	78.7	63.0	52.5	39.4	31.5	26.2	21.0	15.7	3.61	2.41	1.81	1.45
	VC	VC	30	1.30	96.5	77.2	64.4	48.3	38.6	32.2	25.7	19.3	4.43	2.96	2.22	1.77
	C	C	40	1.50	111	89.1	74.3	55.7	44.6	37.1	29.7	22.3	5.12	3.41	2.56	2.05
	C	C	50	1.68	125	99.8	83.2	62.4	49.9	41.6	33.3	24.9	5.73	3.82	2.86	2.29
	C	M	60	1.84	137	109	91.1	68.3	54.6	45.5	36.4	27.3	6.27	4.18	3.14	2.51
	C	M	70	1.98	147	118	98.0	73.5	58.8	49.0	39.2	29.4	6.75	4.50	3.38	2.70

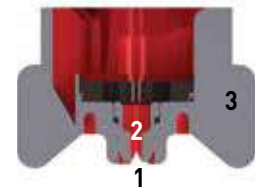

1. Non-Air Inducted; single inlet/outlet design
2. Stainless Steel insert available in a wide flow range
3. Available in a Fastcap option for easy installation



80° or 110° wide spray pattern producing a smaller droplet spectrum with a stainless steel orifice.

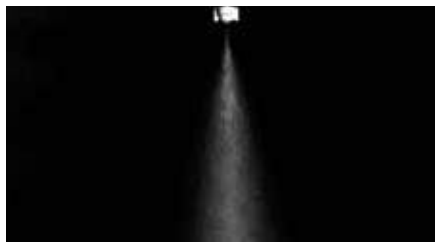

Dense spray pattern of smaller droplets to match many insecticide and fungicide applications.

### Metric Units

Nozzle Size	Droplet Size		Pressure (BAR)	Flow Rate (LPM)	Application Rate L/Ha - 50 cm spacing KM/H							
	80°	110°			7	8	10	12	15	20	25	30
01	M	F	1	0.23	39	35	28	23	18	14	11	9
	F	F	1.5	0.28	48	42	34	28	22	17	13	11
	F	F	2	0.33	57	50	40	33	26	20	16	13
	VF	VF	3	0.40	69	60	48	40	32	24	19	16
	VF	VF	4	0.46	79	69	55	46	37	28	22	18
015	M	M	1	0.35	60	53	42	35	28	21	17	14
	F	F	1.5	0.42	72	63	50	42	34	25	20	17
	F	F	2	0.49	84	74	59	49	39	29	24	20
	F	F	3	0.60	103	90	72	60	48	36	29	24
	VF	VF	4	0.69	118	104	83	69	55	41	33	28
02	M	M	1	0.46	79	69	55	46	37	28	22	18
	F	F	1.5	0.57	98	86	68	57	46	34	27	23
	F	F	2	0.65	111	98	78	65	52	39	31	26
	F	F	3	0.80	137	120	96	80	64	48	38	32
	VF	VF	4	0.92	158	138	110	92	74	55	44	37
03	C	M	1	0.69	118	104	83	69	55	41	33	28
	M	M	1.5	0.85	146	128	102	85	68	51	41	34
	M	M	2	0.98	168	147	118	98	78	59	47	39
	F	F	3	1.20	206	180	144	120	96	72	58	48
	F	F	4	1.39	238	209	167	139	111	83	67	56
04	C	C	1	0.92	158	138	110	92	74	55	44	37
	M	M	1.5	1.13	194	170	136	113	90	68	54	45
	M	M	2	1.31	225	197	157	131	105	79	63	52
	F	F	3	1.60	274	240	192	160	128	96	77	64
	F	F	4	1.85	317	278	222	185	148	111	89	74
05	C	C	1	1.15	197	173	138	115	92	69	55	46
	C	M	1.5	1.41	242	212	169	141	113	85	68	56
	C	M	2	1.63	279	245	196	163	130	98	78	65
	M	F	3	2.00	343	300	240	200	160	120	96	80
	M	F	4	2.31	396	347	277	231	185	139	111	92
06	C	C	1	1.39	238	209	167	139	111	83	67	56
	C	C	1.5	1.70	291	255	204	170	136	102	82	68
	C	C	2	1.96	336	294	235	196	157	118	94	78
	M	M	3	2.40	411	360	288	240	192	144	115	96
	M	F	4	2.77	475	416	332	277	222	166	133	111
08	VC	C	1	1.85	317	278	222	185	148	111	89	74
	C	C	1.5	2.26	387	339	271	226	181	136	108	90
	C	C	2	2.61	447	392	313	261	209	157	125	104
	C	M	3	3.20	549	480	384	320	256	192	154	128
	M	M	4	3.70	634	555	444	370	296	222	178	148
10	VC	VC	1	2.31	396	347	277	231	185	139	111	92
	VC	C	1.5	2.83	485	425	340	283	226	170	136	113
	VC	C	2	3.27	561	491	392	327	262	196	157	131
	C	M	3	4.00	686	600	480	400	320	240	192	160
	C	M	4	4.62	792	693	554	462	370	277	222	185
15	M	M	5	5.16	885	774	619	516	413	310	248	206
	XC	VC	1	3.46	593	519	415	346	277	208	166	138
	VC	VC	1.5	4.24	727	636	509	424	339	254	204	170
	VC	VC	2	4.90	840	735	588	490	392	294	235	196
	C	C	3	6.00	1029	900	720	600	480	360	288	240
15	C	C	4	6.93	1188	1040	832	693	554	416	333	277
	C	M	5	7.75	1329	1163	930	775	620	465	372	310

Droplet size based on ASABE S572.1 standard.

Features	
Common Use	General
Pattern	Tapered Flat Fan
Technology	Elliptical Orifice
Material	Stainless Steel
Spray Angle	80° & 110°
Pressure Range	20-70 PSI (1-5 BAR)
Configuration	Nozzles, FastCap
Optimum Boom Height	
80° - 15" (35 cm) Spacing	22" (56 cm)
80° - 20" (50 cm) Spacing	30" (76 cm)
110° - 15" (35 cm) Spacing	15" (35 cm)
110° - 20" (50 cm) Spacing	20" (50 cm)
Part Numbers	
Nozzles 80°	FastCaps 80°
TR80-01	FC-TR80-01
TR80-015	FC-TR80-015
TR80-02	FC-TR80-02
TR80-03	FC-TR80-03
TR80-04	FC-TR80-04
TR80-05	FC-TR80-05
TR80-06	FC-TR80-06
TR80-08	FC-TR80-08
TR80-10*	FC-TR80-10*
TR80-15*	FC-TR80-15*
Nozzles 110°	FastCaps 110°
TR110-01	FC-TR110-01
TR110-015	FC-TR110-015
TR110-02	FC-TR110-02
TR110-03	FC-TR110-03
TR110-04	FC-TR110-04
TR110-05	FC-TR110-05
TR110-06	FC-TR110-06
TR110-08	FC-TR110-08
TR110-10*	FC-TR110-10*
TR110-15*	FC-TR110-15*
Replacement Cap Gasket	
22W11MF64	

\* All stainless steel nozzles



# Ceramic AXI 80° & 110°



The Albus® AXI wide pressure range ceramic spray nozzles are suited for creating numerous fine to medium droplets. The ceramic orifice of the AXI will provide long service life even when spraying abrasive chemicals.

- Adjustable droplet size according to pressure
- Maintains good spray distribution and makes larger droplets at low pressures
- FastCap includes nozzle, cap and gasket
- 80° fan models ideal for use in directed spray applications  
(See page 180 for more information)

## US Units

Nozzle Size	Droplet Size		Pressure (PSI)	Flow Rate (GPM)	Gallons per Acre 20 inch nozzle spacing MPH								GAL/1000 Ft <sup>2</sup> 20 inch nozzle spacing			
	80°	110°			4	5	6	8	10	12	15	20	2	3	4	5
015	F	F	20	0.11	8.2	6.5	5.4	4.1	3.3	2.7	2.2	1.6	0.38	0.25	0.19	0.15
	F	F	30	0.13	9.7	7.7	6.4	4.8	3.9	3.2	2.6	1.9	0.44	0.30	0.22	0.18
	F	F	40	0.15	11.1	8.9	7.4	5.6	4.5	3.7	3.0	2.2	0.51	0.34	0.26	0.20
	F	F	50	0.17	12.6	10.1	8.4	6.3	5.0	4.2	3.4	2.5	0.58	0.39	0.29	0.23
	VF	F	60	0.18	13.4	10.7	8.9	6.7	5.3	4.5	3.6	2.7	0.61	0.41	0.31	0.25
	VF	F	70	0.20	14.9	11.9	9.9	7.4	5.9	5.0	4.0	3.0	0.68	0.45	0.34	0.27
02	F	F	20	0.14	10.4	8.3	6.9	5.2	4.2	3.5	2.8	2.1	0.48	0.32	0.24	0.19
	F	F	30	0.17	12.6	10.1	8.4	6.3	5.0	4.2	3.4	2.5	0.58	0.39	0.29	0.23
	F	F	40	0.20	14.9	11.9	9.9	7.4	5.9	5.0	4.0	3.0	0.68	0.45	0.34	0.27
	F	F	50	0.22	16.3	13.1	10.9	8.2	6.5	5.4	4.4	3.3	0.75	0.50	0.38	0.30
	F	F	60	0.24	17.8	14.3	11.9	8.9	7.1	5.9	4.8	3.6	0.82	0.55	0.41	0.33
	F	F	70	0.26	19.3	15.4	12.9	9.7	7.7	6.4	5.1	3.9	0.89	0.59	0.44	0.35
03	M	M	20	0.21	15.6	12.5	10.4	7.8	6.2	5.2	4.2	3.1	0.72	0.48	0.36	0.29
	M	F	30	0.26	19.3	15.4	12.9	9.7	7.7	6.4	5.1	3.9	0.89	0.59	0.44	0.35
	M	F	40	0.30	22.3	17.8	14.9	11.1	8.9	7.4	5.9	4.5	1.02	0.68	0.51	0.41
	F	F	50	0.34	25.2	20.2	16.8	12.6	10.1	8.4	6.7	5.0	1.16	0.77	0.58	0.46
	F	F	60	0.37	27.5	22.0	18.3	13.7	11.0	9.2	7.3	5.5	1.26	0.84	0.63	0.50
	F	F	70	0.40	29.7	23.8	19.8	14.9	11.9	9.9	7.9	5.9	1.36	0.91	0.68	0.55
04	M	M	20	0.28	20.8	16.6	13.9	10.4	8.3	6.9	5.5	4.2	0.95	0.64	0.48	0.38
	M	M	30	0.35	26.0	20.8	17.3	13.0	10.4	8.7	6.9	5.2	1.19	0.80	0.60	0.48
	M	F	40	0.40	29.7	23.8	19.8	14.9	11.9	9.9	7.9	5.9	1.36	0.91	0.68	0.55
	M	F	50	0.45	33.4	26.7	22.3	16.7	13.4	11.1	8.9	6.7	1.53	1.02	0.77	0.61
	F	F	60	0.49	36.4	29.1	24.3	18.2	14.6	12.1	9.7	7.3	1.67	1.11	0.84	0.67
	F	F	70	0.53	39.4	31.5	26.2	19.7	15.7	13.1	10.5	7.9	1.81	1.20	0.90	0.72
05	M	M	20	0.35	26.0	20.8	17.3	13.0	10.4	8.7	6.9	5.2	1.19	0.80	0.60	0.48
	M	M	30	0.43	31.9	25.5	21.3	16.0	12.8	10.6	8.5	6.4	1.47	0.98	0.73	0.59
	M	F	40	0.50	37.1	29.7	24.8	18.6	14.9	12.4	9.9	7.4	1.71	1.14	0.85	0.68
	M	F	50	0.56	41.6	33.3	27.7	20.8	16.6	13.9	11.1	8.3	1.91	1.27	0.95	0.76
	M	F	60	0.61	45.3	36.2	30.2	22.6	18.1	15.1	12.1	9.1	2.08	1.39	1.04	0.83
	M	F	70	0.66	49.0	39.2	32.7	24.5	19.6	16.3	13.1	9.8	2.25	1.50	1.13	0.90
06	M	M	20	0.42	31.2	24.9	20.8	15.6	12.5	10.4	8.3	6.2	1.43	0.95	0.72	0.57
	M	M	30	0.52	38.6	30.9	25.7	19.3	15.4	12.9	10.3	7.7	1.77	1.18	0.89	0.71
	M	M	40	0.60	44.6	35.6	29.7	22.3	17.8	14.9	11.9	8.9	2.05	1.36	1.02	0.82
	M	F	50	0.67	49.7	39.8	33.2	24.9	19.9	16.6	13.3	9.9	2.28	1.52	1.14	0.91
	M	F	60	0.73	54.2	43.4	36.1	27.1	21.7	18.1	14.5	10.8	2.49	1.66	1.24	1.00
	M	F	70	0.79	58.7	46.9	39.1	29.3	23.5	19.6	15.6	11.7	2.69	1.80	1.35	1.08

Droplet size based on ASABE S572.1 standard.



### Metric Units

Nozzle Size	Droplet Size		Pressure (BAR)	Flow Rate (LPM)	Application Rate L/Ha - 50 cm spacing KM/H									
	80°	110°			6	8	10	12	14	16	18	20	25	30
015	F	F	2	0.49	129	97	77	64	55	48	43	39	31	26
	F	F	3	0.60	158	118	95	79	68	59	53	47	38	32
	F	F	4	0.69	182	136	109	91	78	68	61	54	44	36
	VF	F	5	0.77	203	152	122	101	87	76	68	61	49	41
02	M	F	2	0.65	171	128	103	86	73	64	57	51	41	34
	F	F	3	0.80	211	158	126	105	90	79	70	63	51	42
	F	F	4	0.92	242	182	145	121	104	91	81	73	58	48
	F	F	5	1.03	271	203	163	136	116	102	90	81	65	54
03	M	F	2	0.98	258	193	155	129	111	97	86	77	62	52
	M	F	3	1.20	316	237	189	158	135	118	105	95	76	63
	F	F	4	1.39	366	274	219	183	157	137	122	110	88	73
	F	F	5	1.55	408	306	245	204	175	153	136	122	98	82
04	M	M	2	1.31	345	259	207	172	148	129	115	103	83	69
	M	F	3	1.60	421	316	253	211	180	158	140	126	101	84
	M	F	4	1.85	487	365	292	243	209	183	162	146	117	97
	F	F	5	2.07	545	409	327	272	233	204	182	163	131	109
05	M	M	2	1.63	429	322	257	214	184	161	143	129	103	86
	M	F	3	2.00	526	395	316	263	226	197	175	158	126	105
	M	F	4	2.31	608	456	365	304	261	228	203	182	146	122
	M	F	5	2.58	679	509	407	339	291	255	226	204	163	136
06	M	M	2	1.96	516	387	309	258	221	193	172	155	124	103
	M	F	3	2.40	632	474	379	316	271	237	211	189	152	126
	M	F	4	2.77	729	547	437	364	312	273	243	219	175	146
	M	F	5	3.10	816	612	489	408	350	306	272	245	196	163

Droplet size based on ASABE S572.1 standard.

Features	
Common Use	General
Pattern	Tapered Flat Fan
Technology	Elliptical Orifice
Material	Ceramic
Spray Angle	80° & 110°
Pressure Range	20-70 PSI (1.5-5 BAR)
Configuration	Nozzles, FastCap
Optimum Boom Height	
80° - 15" (35 cm) Spacing	22" (56 cm)
80° - 20" (50 cm) Spacing	30" (76 cm)
110° - 15" (35 cm) Spacing	15" (35 cm)
110° - 20" (50 cm) Spacing	20" (50 cm)
Part Numbers	
Nozzles 80°	FastCaps 80°
AXI-80015	FC-AXI-80015
AXI-8002	FC-AXI-8002
AXI-8003	FC-AXI-8003
AXI-8004	FC-AXI-8004
AXI-8005	FC-AXI-8005
AXI-8006	FC-AXI-8006
Nozzles 110°	FastCaps 110°
AXI-110015	FC-AXI-110015
AXI-11002	FC-AXI-11002
AXI-110025	-
AXI-11003	FC-AXI-11003
AXI-11004	FC-AXI-11004
AXI-11005	FC-AXI-11005
AXI-11006	FC-AXI-11006
Replacement Cap Gasket	
22W11MF64	



# VP Tech 80° & 110°



One VP nozzle and a removable blanking insert in a standard TwinCap for 30° inclined spray.

- Variable pressure nozzles maintain constant spray angle over a wide pressure range down to 20 psi (1 bar)
- Available in 80° and 110° versions to work at different boom heights
- Alternate the direction of the incline along the boom for optimum coverage of vertical targets

## US Units

Nozzle Size	Droplet Size		Pressure (PSI)	Flow Rate (GPM)	Gallons per Acre 20 inch nozzle spacing MPH								GAL/1000 <sup>R1</sup> 20 inch nozzle spacing			
	80°	110°			4	5	6	8	10	12	15	20	2	3	4	5
02	-	-	20	0.14	10.4	8.3	6.9	5.2	4.2	3.5	2.8	2.1	0.48	0.32	0.24	0.19
	F	F	30	0.17	12.6	10.1	8.4	6.3	5.0	4.2	3.4	2.5	0.58	0.39	0.29	0.23
	F	F	40	0.20	14.9	11.9	9.9	7.4	5.9	5.0	4.0	3.0	0.68	0.45	0.34	0.27
	F	F	50	0.22	16.3	13.1	10.9	8.2	6.5	5.4	4.4	3.3	0.75	0.50	0.38	0.30
	F	F	60	0.24	17.8	14.3	11.9	8.9	7.1	5.9	4.8	3.6	0.82	0.55	0.41	0.33
	F	F	70	0.26	19.3	15.4	12.9	9.7	7.7	6.4	5.1	3.9	0.89	0.59	0.44	0.35
025	-	M	20	0.18	13.4	10.7	8.9	6.7	5.3	4.5	3.6	2.7	0.61	0.41	0.31	0.25
	-	F	30	0.22	16.3	13.1	10.9	8.2	6.5	5.4	4.4	3.3	0.75	0.50	0.38	0.30
	-	F	40	0.25	18.6	14.9	12.4	9.3	7.4	6.2	5.0	3.7	0.85	0.57	0.43	0.34
	-	F	50	0.28	20.8	16.6	13.9	10.4	8.3	6.9	5.5	4.2	0.95	0.64	0.48	0.38
	-	F	60	0.31	23.0	18.4	15.3	11.5	9.2	7.7	6.1	4.6	1.06	0.70	0.53	0.42
	-	F	70	0.33	24.5	19.6	16.3	12.3	9.8	8.2	6.5	4.9	1.13	0.75	0.56	0.45
03	M	M	20	0.21	15.6	12.5	10.4	7.8	6.2	5.2	4.2	3.1	0.72	0.48	0.36	0.29
	M	F	30	0.26	19.3	15.4	12.9	9.7	7.7	6.4	5.1	3.9	0.89	0.59	0.44	0.35
	F	F	40	0.30	22.3	17.8	14.9	11.1	8.9	7.4	5.9	4.5	1.02	0.68	0.51	0.41
	F	F	50	0.34	25.2	20.2	16.8	12.6	10.1	8.4	6.7	5.0	1.16	0.77	0.58	0.46
	F	F	60	0.37	27.5	22.0	18.3	13.7	11.0	9.2	7.3	5.5	1.26	0.84	0.63	0.50
	F	F	70	0.40	29.7	23.8	19.8	14.9	11.9	9.9	7.9	5.9	1.36	0.91	0.68	0.55
035	-	M	20	0.25	18.6	14.9	12.4	9.3	7.4	6.2	5.0	3.7	0.85	0.57	0.43	0.34
	-	F	30	0.30	22.3	17.8	14.9	11.1	8.9	7.4	5.9	4.5	1.02	0.68	0.51	0.41
	-	F	40	0.35	26.0	20.8	17.3	13.0	10.4	8.7	6.9	5.2	1.19	0.80	0.60	0.48
	-	F	50	0.39	29.0	23.2	19.3	14.5	11.6	9.7	7.7	5.8	1.33	0.89	0.66	0.53
	-	F	60	0.43	31.9	25.5	21.3	16.0	12.8	10.6	8.5	6.4	1.47	0.98	0.73	0.59
	-	F	70	0.46	34.2	27.3	22.8	17.1	13.7	11.4	9.1	6.8	1.57	1.05	0.78	0.63
04	C	M	20	0.28	20.8	16.6	13.9	10.4	8.3	6.9	5.5	4.2	0.95	0.64	0.48	0.38
	M	M	30	0.35	26.0	20.8	17.3	13.0	10.4	8.7	6.9	5.2	1.19	0.80	0.60	0.48
	F	F	40	0.40	29.7	23.8	19.8	14.9	11.9	9.9	7.9	5.9	1.36	0.91	0.68	0.55
	F	F	50	0.45	33.4	26.7	22.3	16.7	13.4	11.1	8.9	6.7	1.53	1.02	0.77	0.61
	F	F	60	0.49	36.4	29.1	24.3	18.2	14.6	12.1	9.7	7.3	1.67	1.11	0.84	0.67
	F	F	70	0.53	39.4	31.5	26.2	19.7	15.7	13.1	10.5	7.9	1.81	1.20	0.90	0.72
05	C	M	20	0.35	26.0	20.8	17.3	13.0	10.4	8.7	6.9	5.2	1.19	0.80	0.60	0.48
	M	M	30	0.43	31.9	25.5	21.3	16.0	12.8	10.6	8.5	6.4	1.47	0.98	0.73	0.59
	F	F	40	0.50	37.1	29.7	24.8	18.6	14.9	12.4	9.9	7.4	1.71	1.14	0.85	0.68
	F	F	50	0.56	41.6	33.3	27.7	20.8	16.6	13.9	11.1	8.3	1.91	1.27	0.95	0.76
	F	F	60	0.61	45.3	36.2	30.2	22.6	18.1	15.1	12.1	9.1	2.08	1.39	1.04	0.83
	F	F	70	0.66	49.0	39.2	32.7	24.5	19.6	16.3	13.1	9.8	2.25	1.50	1.13	0.90
06	C	M	20	0.42	31.2	24.9	20.8	15.6	12.5	10.4	8.3	6.2	1.43	0.95	0.72	0.57
	M	M	30	0.52	38.6	30.9	25.7	19.3	15.4	12.9	10.3	7.7	1.77	1.18	0.89	0.71
	F	F	40	0.60	44.6	35.6	29.7	22.3	17.8	14.9	11.9	8.9	2.05	1.36	1.02	0.82
	F	F	50	0.67	49.7	39.8	33.2	24.9	19.9	16.6	13.3	9.9	2.28	1.52	1.14	0.91
	F	F	60	0.73	54.2	43.4	36.1	27.1	21.7	18.1	14.5	10.8	2.49	1.66	1.24	1.00
	F	F	70	0.79	58.7	46.9	39.1	29.3	23.5	19.6	15.6	11.7	2.69	1.80	1.35	1.08

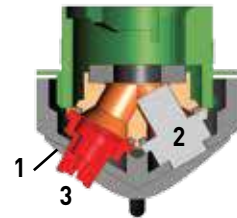

1. Inclined spray for vertical targets
2. Removable blanking insert
3. Fully formed spray pattern at low pressures

Droplet size based on ASABE S572.1 standard.



Low pressure performance allows for complete pattern formation and even coverage down to 15 psi (1 BAR).



Inclined 30° spray pattern of medium to fine droplets provides superior coverage and canopy penetration.

### Metric Units

Nozzle Size	ASABE Droplet Size		Pressure [BAR]	Flow Rate (LPM)	Application Rate L/Ha - 50 cm spacing KM/H							
	80°	110°			7	8	10	12	15	20	25	30
02	-	-	1	0,46	79	69	55	46	37	28	22	18
	-	-	1,5	0,57	98	86	68	57	46	34	27	23
	F	F	2	0,65	111	98	78	65	52	39	31	26
	F	F	3	0,80	137	120	96	80	64	48	38	32
	F	F	4	0,92	158	138	110	92	74	55	44	37
025	-	M	1	0,58	99	87	70	58	46	35	28	23
	-	M	1,5	0,71	122	107	85	71	57	43	34	28
	-	F	2	0,82	141	123	98	82	66	49	39	33
	-	F	3	1,00	171	150	120	100	80	60	48	40
	-	F	4	1,15	197	173	138	115	92	69	55	46
03	-	F	5	1,29	221	194	155	129	103	77	62	52
	C	M	1	0,69	118	104	83	69	55	41	33	28
	M	M	1,5	0,85	146	128	102	85	68	51	41	34
	M	F	2	0,98	168	147	118	98	78	59	47	39
	F	F	3	1,20	206	180	144	120	96	72	58	48
035	F	F	4	1,39	238	209	167	139	111	83	67	56
	F	F	5	1,55	266	233	186	155	124	93	74	62
	-	M	1	0,81	139	122	97	81	65	49	39	32
	-	M	1,5	0,99	170	149	119	99	79	59	48	40
	-	M	2	1,14	195	171	137	114	91	68	55	46
04	-	F	3	1,40	240	210	168	140	112	84	67	56
	-	F	4	1,62	278	243	194	162	130	97	78	65
	-	F	5	1,81	310	272	217	181	145	109	87	72
	C	M	1	0,92	158	138	110	92	74	55	44	37
	C	M	1,5	1,13	194	170	136	113	90	68	54	45
05	M	M	2	1,31	225	197	157	131	105	79	63	52
	M	F	3	1,60	274	240	192	160	128	96	77	64
	F	F	4	1,85	317	278	222	185	148	111	89	74
	F	F	5	2,07	355	311	248	207	166	124	99	83
	C	M	1	1,15	197	173	138	115	92	69	55	46
06	C	M	1,5	1,41	242	212	169	141	113	85	68	56
	C	M	2	1,63	279	245	196	163	130	98	78	65
	M	F	3	2,00	343	300	240	200	160	120	96	80
	M	F	4	2,31	396	347	277	231	185	139	111	92
	M	F	5	2,58	442	387	310	258	206	155	124	103
06	C	C	1	1,39	238	209	167	139	111	83	67	56
	C	M	1,5	1,70	291	255	204	170	136	102	82	68
	C	M	2	1,96	336	294	235	196	157	118	94	78
	M	M	3	2,40	411	360	288	240	192	144	115	96
	M	F	4	2,77	475	416	332	277	222	166	133	111
06	M	F	5	3,10	531	465	372	310	248	186	149	124

Droplet size based on ASABE S572.1 standard.

Features	
Common Use	General
Pattern	Tapered Flat Fan
Technology	Elliptical Orifice
Material	Polycetal
Spray Angle	80° & 110°
Pressure Range	20-70 PSI (1-5 BAR)
Configuration	TwinCap
Optimum Boom Height	
80° - 15" (35 cm) Spacing	20" (51 cm)
80° - 20" (50 cm) Spacing	28" (71 cm)
110° - 15" (35 cm) Spacing	13" (33 cm)
110° - 20" (50 cm) Spacing	18" (46 cm)
Part Numbers	
TwinCap 80°	TwinCap 110°
VPT80-02	VPT110-02
-	VPT110-025
VPT80-03	VPT110-03
-	VPT110-035
VPT80-04	VPT110-04
VPT80-05	VPT110-05
VPT80-06	VPT110-06
Replacement Parts	
VPTCAP	Cap & Blanking Insert
30Q3834	Blanking Insert
22W11MF64	Cap Gasket

Add suffix "-H" for Hardi compatible products



# FanTip 80° & 110°



The FanTip is a general spray nozzle that produces a mixed droplet spectrum over the 30-60 psi (2-4 bar) operational pressure range. It is good for broadcast applications.

- Economical option for general spraying
- Simple one-piece design
- Polyacetal construction for superior product life compared to stainless steel or brass

## US Units

Nozzle Size	Droplet Size		Pressure Flow Rate		Gallons per Acre 20 inch nozzle spacing								GAL/1000 <sup>ft</sup>			
	80°	110°	(PSI)	(GPM)	MPH								20 inch nozzle spacing			
					4	5	6	8	10	12	15	20	2	3	4	5
0067	F	-	30	0.058	4.3	3.4	2.9	2.2	1.7	1.4	1.1	0.9	0.20	0.13	0.10	0.08
	VF	-	40	0.067	5.0	4.0	3.3	2.5	2.0	1.7	1.3	1.0	0.23	0.15	0.11	0.09
	VF	-	50	0.075	5.6	4.5	3.7	2.8	2.2	1.9	1.5	1.1	0.26	0.17	0.13	0.10
	VF	-	60	0.082	6.1	4.9	4.1	3.0	2.4	2.0	1.6	1.2	0.28	0.19	0.14	0.11
01	VF	F	30	0.09	6.7	5.3	4.5	3.3	2.7	2.2	1.8	1.3	0.31	0.20	0.15	0.12
	VF	F	40	0.10	7.4	5.9	5.0	3.7	3.0	2.5	2.0	1.5	0.34	0.23	0.17	0.14
	VF	F	50	0.11	8.2	6.5	5.4	4.1	3.3	2.7	2.2	1.6	0.38	0.25	0.19	0.15
	VF	VF	60	0.12	8.9	7.1	5.9	4.5	3.6	3.0	2.4	1.8	0.41	0.27	0.20	0.16
015	F	F	30	0.13	9.7	7.7	6.4	4.8	3.9	3.2	2.6	1.9	0.44	0.30	0.22	0.18
	F	F	40	0.15	11.1	8.9	7.4	5.6	4.5	3.7	3.0	2.2	0.51	0.34	0.26	0.20
	F	F	50	0.17	12.6	10.1	8.4	6.3	5.0	4.2	3.4	2.5	0.58	0.39	0.29	0.23
	VF	F	60	0.18	13.4	10.7	8.9	6.7	5.3	4.5	3.6	2.7	0.61	0.41	0.31	0.25
02	M	F	30	0.17	12.6	10.1	8.4	6.3	5.0	4.2	3.4	2.5	0.58	0.39	0.29	0.23
	F	F	40	0.20	14.9	11.9	9.9	7.4	5.9	5.0	4.0	3.0	0.68	0.45	0.34	0.27
	F	F	50	0.22	16.3	13.1	10.9	8.2	6.5	5.4	4.4	3.3	0.75	0.50	0.38	0.30
	F	F	60	0.24	17.8	14.3	11.9	8.9	7.1	5.9	4.8	3.6	0.82	0.55	0.41	0.33
03	C	F	30	0.26	19.3	15.4	12.9	9.7	7.7	6.4	5.1	3.9	0.89	0.59	0.44	0.35
	M	F	40	0.30	22.3	17.8	14.9	11.1	8.9	7.4	5.9	4.5	1.02	0.68	0.51	0.41
	F	F	50	0.34	25.2	20.2	16.8	12.6	10.1	8.4	6.7	5.0	1.16	0.77	0.58	0.46
	F	F	60	0.37	27.5	22.0	18.3	13.7	11.0	9.2	7.3	5.5	1.26	0.84	0.63	0.50
04	C	M	30	0.35	26.0	20.8	17.3	13.0	10.4	8.7	6.9	5.2	1.19	0.80	0.60	0.48
	M	F	40	0.40	29.7	23.8	19.8	14.9	11.9	9.9	7.9	5.9	1.36	0.91	0.68	0.55
	M	F	50	0.45	33.4	26.7	22.3	16.7	13.4	11.1	8.9	6.7	1.53	1.02	0.77	0.61
	F	F	60	0.49	36.4	29.1	24.3	18.2	14.6	12.1	9.7	7.3	1.67	1.11	0.84	0.67
05	C	M	30	0.43	31.9	25.5	21.3	16.0	12.8	10.6	8.5	6.4	1.47	0.98	0.73	0.59
	M	F	40	0.50	37.1	29.7	24.8	18.6	14.9	12.4	9.9	7.4	1.71	1.14	0.85	0.68
	M	F	50	0.56	41.6	33.3	27.7	20.8	16.6	13.9	11.1	8.3	1.91	1.27	0.95	0.76
	M	F	60	0.61	45.3	36.2	30.2	22.6	18.1	15.1	12.1	9.1	2.08	1.39	1.04	0.83
06	C	M	30	0.52	38.6	30.9	25.7	19.3	15.4	12.9	10.3	7.7	1.77	1.18	0.89	0.71
	C	M	40	0.60	44.6	35.6	29.7	22.3	17.8	14.9	11.9	8.9	2.05	1.36	1.02	0.82
	C	F	50	0.67	49.7	39.8	33.2	24.9	19.9	16.6	13.3	9.9	2.28	1.52	1.14	0.91
	C	F	60	0.73	54.2	43.4	36.1	27.1	21.7	18.1	14.5	10.8	2.49	1.66	1.24	1.00
08	VC	M	30	0.69	51.2	41.0	34.2	25.6	20.5	17.1	13.7	10.2	2.35	1.57	1.18	0.94
	C	M	40	0.80	59.4	47.5	39.6	29.7	23.8	19.8	15.8	11.9	2.73	1.82	1.36	1.09
	C	M	50	0.89	66.1	52.9	44.1	33.0	26.4	22.0	17.6	13.2	3.03	2.02	1.52	1.21
	C	M	60	0.98	72.8	58.2	48.5	36.4	29.1	24.3	19.4	14.6	3.34	2.23	1.67	1.34
10	VC	C	30	0.87	64.6	51.7	43.1	32.3	25.8	21.5	17.2	12.9	2.97	1.98	1.48	1.19
	C	C	40	1.00	74.3	59.4	49.5	37.1	29.7	24.8	19.8	14.9	3.41	2.27	1.71	1.36
	C	C	50	1.12	83.2	66.5	55.4	41.6	33.3	27.7	22.2	16.6	3.82	2.55	1.91	1.53
	C	C	60	1.22	90.6	72.5	60.4	45.3	36.2	30.2	24.2	18.1	4.16	2.77	2.08	1.66
15	VC	C	30	1.30	96.5	77.2	64.4	48.3	38.6	32.2	25.7	19.3	4.43	2.96	2.22	1.77
	C	C	40	1.50	111	89.1	74.3	55.7	44.6	37.1	29.7	22.3	5.12	3.41	2.56	2.05
	VC	C	50	1.68	125	99.8	83.2	62.4	49.9	41.6	33.3	24.9	5.73	3.82	2.86	2.29
	C	C	60	1.84	137	109	91.1	68.3	54.6	45.5	36.4	27.3	6.27	4.18	3.14	2.51
20	VC	C	30	1.73	128	103	85.6	64.2	51.4	42.8	34.3	25.7	5.90	3.93	2.95	2.36
	VC	C	40	2.00	149	119	99.0	74.3	59.4	49.5	39.6	29.7	6.82	4.55	3.41	2.73
	VC	C	50	2.24	166	133	111	83.2	66.5	55.4	44.4	33.3	7.64	5.09	3.82	3.06
	VC	C	60	2.45	182	146	121	91.0	72.8	60.6	48.5	36.4	8.35	5.57	4.18	3.34

Droplet size based on ASABE S572.1 standard.

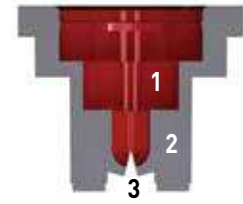

1. Simple; Non-Air Inducted technology
2. Polyacetal; single piece design
3. Available in many sizes to meet your flow rate needs



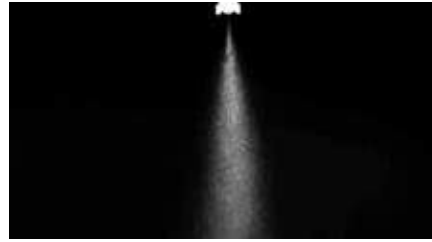
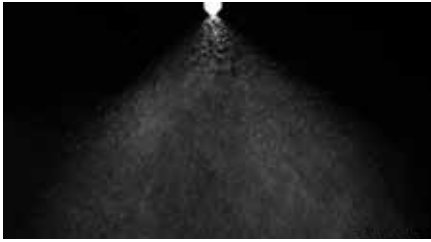

80° or 110° wide spray patterns; broad flow range and droplet spectrum to fit many spraying applications.

Polyacetal construction provides a wear resistant orifice to ensure pattern integrity.

### Metric Units

Nozzle Size	ASABE Droplet Size		Pressure (BAR)	Flow Rate (LPM)	Application Rate L/Ha- 50 cm Spacing KM/H							
	80°	110°			7	8	10	12	15	20	25	30
0067	F	-	2	0,22	38	33	26	22	18	13	11	9
	VF	-	2,5	0,25	43	38	30	25	20	15	12	10
	VF	-	3	0,27	46	41	32	27	22	16	13	11
	VF	-	4	0,31	53	47	37	31	25	19	15	12
01	VF	F	2	0,33	57	50	40	33	26	20	16	13
	VF	F	2,5	0,37	63	56	44	37	30	22	18	15
	VF	F	3	0,40	69	60	48	40	32	24	19	16
	VF	VF	4	0,46	79	69	55	46	37	28	22	18
015	F	F	2	0,49	84	74	59	49	39	29	24	20
	F	F	2,5	0,55	94	83	66	55	44	33	26	22
	F	F	3	0,60	103	90	72	60	48	36	29	24
	VF	F	4	0,69	118	104	83	69	55	41	33	28
02	M	F	2	0,65	111	98	78	65	52	39	31	26
	F	F	2,5	0,73	125	110	88	73	58	44	35	29
	F	F	3	0,80	137	120	96	80	64	48	38	32
	F	F	4	0,92	158	138	110	92	74	55	44	37
03	C	F	2	0,98	168	147	118	98	78	59	47	39
	M	F	2,5	1,10	189	165	132	110	88	66	53	44
	M	F	3	1,20	206	180	144	120	96	72	58	48
	F	F	4	1,39	238	209	167	139	111	83	67	56
04	C	M	2	1,31	225	197	157	131	105	79	63	52
	M	F	2,5	1,46	250	219	175	146	117	88	70	58
	M	F	3	1,60	274	240	192	160	128	96	77	64
	M	F	4	1,85	317	278	222	185	148	111	89	74
05	C	M	2	1,63	279	245	196	163	130	98	78	65
	M	M	2,5	1,83	314	275	220	183	146	110	88	73
	M	F	3	2,00	343	300	240	200	160	120	96	80
	M	F	4	2,31	396	347	277	231	185	139	111	92
06	C	M	2	1,96	336	294	235	196	157	118	94	78
	C	M	2,5	2,19	375	329	263	219	175	131	105	88
	C	F	3	2,40	411	360	288	240	192	144	115	96
	C	F	4	2,77	475	416	332	277	222	166	133	111
08	VC	M	2	2,61	447	392	313	261	209	157	125	104
	C	M	2,5	2,92	501	438	350	292	234	175	140	117
	C	M	3	3,20	549	480	384	320	256	192	154	128
	C	M	4	3,70	634	555	444	370	296	222	178	148
10	VC	C	2	3,27	561	491	392	327	262	196	157	131
	C	C	2,5	3,65	626	548	438	365	292	219	175	146
	C	C	3	4,00	686	600	480	400	320	240	192	160
	C	C	4	4,62	792	693	554	462	370	277	222	185
15	VC	C	2	4,90	840	735	588	490	392	294	235	196
	VC	C	2,5	5,48	939	822	658	548	438	329	263	219
	VC	C	3	6,00	1029	900	720	600	480	360	288	240
	C	C	4	6,93	1188	1040	832	693	554	416	333	277
20	VC	C	2	6,53	1119	980	784	653	522	392	313	261
	VC	C	2,5	7,30	1251	1095	876	730	584	438	350	292
	VC	C	3	8,00	1371	1200	960	800	640	480	384	320
	VC	C	4	9,24	1584	1386	1109	924	739	554	444	370

Droplet size based on ASABE S572.1 standard.

Features		
Common Use	General	
Pattern	Tapered Flat Fan	
Technology	Elliptical Orifice	
Material	Polyacetal	
Spray Angle	80° & 110°	
Pressure Range	30-60 PSI (2-4 BAR)	
Configuration	Nozzle	
Optimum Boom Height		
80° - 15" (35 cm) Spacing	22" (56 cm)	
80° - 20" (50 cm) Spacing	30" (76 cm)	
110° - 15" (35 cm) Spacing	15" (35 cm)	
110° - 20" (50 cm) Spacing	20" (50 cm)	
Part Numbers		
Nozzles 80°	Nozzles 110°	Caps (25 Pack)
F80-0067	-	CAP00-20
F80-01	F110-01	CAP00-01
F80-015	F110-015	CAP00-015
F80-02	F110-02	CAP00-02
F80-03	F110-03	CAP00-03
F80-04	F110-04	CAP00-04
F80-05	F110-05	CAP00-05
F80-06	F110-06	CAP00-06
F80-08	F110-08	CAP00-08
F80-10	F110-10	CAP00-10
F80-15	F110-15	CAP00-15
F80-20	F110-20	CAP00-20

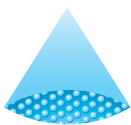

# Hi-Flow 140°



The Hypro® Hi-Flow nozzle is the best way to outfit a sprayer to achieve wide-angle coverage plus drift control. The 140° pattern ensures unmatched uniformity across the spray boom and allows lower spray heights to reduce the risk of drift during sensitive applications.

- Frequently used with fertilizer/herbicide mixtures for early season weed control
- Straight-through design to reduce clogging and drift
- Incredibly uniform application across the boom
- Lower spray heights and pre-orifice technology reduce drift
- PWM compatible

## US Units

Nozzle Size	Droplet Size	Pressure (PSI)	Flow Rate (GPM)	Gallons per Acre 20 inch nozzle spacing MPH								GAL/1000ft <sup>2</sup> 20 inch nozzle spacing				
				4	5	6	8	10	12	15	20	2	3	4	5	
08	UC	20	0.57	42.3	33.9	28.2	21.2	16.9	14.1	11.3	8.5	1.94	1.30	0.97	0.78	
	UC	30	0.69	51.2	41.0	34.2	25.6	20.5	17.1	13.7	10.2	2.35	1.57	1.18	0.94	
	UC	40	0.80	59.4	47.5	39.6	29.7	23.8	19.8	15.8	11.9	2.73	1.82	1.36	1.09	
	UC	50	0.89	66.1	52.9	44.1	33.0	26.4	22.0	17.6	13.2	3.03	2.02	1.52	1.21	
	XC	60	0.98	72.8	58.2	48.5	36.4	29.1	24.3	19.4	14.6	3.34	2.23	1.67	1.34	
	XC	70	1.06	78.7	63.0	52.5	39.4	31.5	26.2	21.0	15.7	3.61	2.41	1.81	1.45	
10	UC	20	0.71	52.7	42.2	35.1	26.4	21.1	17.6	14.1	10.5	2.42	1.61	1.21	0.97	
	UC	30	0.87	64.6	51.7	43.1	32.3	25.8	21.5	17.2	12.9	2.97	1.98	1.48	1.19	
	UC	40	1.00	74.3	59.4	49.5	37.1	29.7	24.8	19.8	14.9	3.41	2.27	1.71	1.36	
	UC	50	1.12	83.2	66.5	55.4	41.6	33.3	27.7	22.2	16.6	3.82	2.55	1.91	1.53	
	XC	60	1.22	90.6	72.5	60.4	45.3	36.2	30.2	24.2	18.1	4.16	2.77	2.08	1.66	
	XC	70	1.32	98.0	78.4	65.3	49.0	39.2	32.7	26.1	19.6	4.50	3.00	2.25	1.80	
15	UC	20	1.06	78.7	63.0	52.5	39.4	31.5	26.2	21.0	15.7	3.61	2.41	1.81	1.45	
	UC	30	1.30	96.5	77.2	64.4	48.3	38.6	32.2	25.7	19.3	4.43	2.96	2.22	1.77	
	UC	40	1.50	111	89.1	74.3	55.7	44.6	37.1	29.7	22.3	5.12	3.41	2.56	2.05	
	UC	50	1.68	125	99.8	83.2	62.4	49.9	41.6	33.3	24.9	5.73	3.82	2.86	2.29	
	XC	60	1.84	137	109	91.1	68.3	54.6	45.5	36.4	27.3	6.27	4.18	3.14	2.51	
	XC	70	1.98	147	118	98.0	73.5	58.8	49.0	39.2	29.4	6.75	4.50	3.38	2.70	
20	UC	20	1.41	105	83.8	69.8	52.3	41.9	34.9	27.9	20.9	4.81	3.21	2.40	1.92	
	UC	30	1.73	128	103	85.6	64.2	51.4	42.8	34.3	25.7	5.90	3.93	2.95	2.36	
	UC	40	2.00	149	119	99.0	74.3	59.4	49.5	39.6	29.7	6.82	4.55	3.41	2.73	
	UC	50	2.24	166	133	111	83.2	66.5	55.4	44.4	33.3	7.64	5.09	3.82	3.06	
	XC	60	2.45	182	146	121	91.0	72.8	60.6	48.5	36.4	8.35	5.57	4.18	3.34	
	XC	70	2.65	197	157	131	98.4	78.7	65.6	52.5	39.4	9.04	6.02	4.52	3.61	
30	UC	20	2.12	157	126	105	78.7	63.0	52.5	42.0	31.5	7.23	4.82	3.61	2.89	
	UC	30	2.60	193	154	129	96.5	77.2	64.4	51.5	38.6	8.87	5.91	4.43	3.55	
	UC	40	3.00	223	178	149	111	89.1	74.3	59.4	44.6	10.2	6.82	5.12	4.09	
	UC	50	3.35	249	199	166	124	99.5	82.9	66.3	49.7	11.4	7.62	5.71	4.57	
	XC	60	3.67	272	218	182	136	109	90.8	72.7	54.5	12.5	8.34	6.26	5.01	
	XC	70	3.97	295	236	197	147	118	98.3	78.6	59.0	13.5	9.03	6.77	5.42	
40	UC	20	2.83	210	168	140	105	84.1	70.0	56.0	42.0	9.65	6.43	4.83	3.86	
	UC	30	3.46	257	206	171	128	103	85.6	68.5	51.4	11.8	7.87	5.90	4.72	
	UC	40	4.00	297	238	198	149	119	99.0	79.2	59.4	13.6	9.09	6.82	5.46	
	UC	50	4.47	332	266	221	166	133	111	88.5	66.4	15.2	10.2	7.62	6.10	
	XC	60	4.90	364	291	243	182	146	121	97.0	72.8	16.7	11.1	8.35	6.68	
	XC	70	5.29	393	314	262	196	157	131	105	78.6	18.0	12.0	9.02	7.22	
50	UC	20	3.54	263	210	175	131	105	87.6	70.1	52.6	12.1	8.05	6.04	4.83	
	UC	30	4.33	322	257	214	161	129	107	85.7	64.3	14.8	9.84	7.38	5.91	
	UC	40	5.00	371	297	248	186	149	124	99.0	74.3	17.1	11.4	8.53	6.82	
	UC	50	5.59	415	332	277	208	166	138	111	83.0	19.1	12.7	9.53	7.62	
	XC	60	6.12	454	364	303	227	182	151	121	90.9	20.9	13.9	10.4	8.35	
	XC	70	6.61	491	393	327	245	196	164	131	98.2	22.5	15.0	11.3	9.02	
60	UC	20	4.24	315	252	210	157	126	105	84.0	63.0	14.5	9.64	7.23	5.78	
	UC	30	5.20	386	309	257	193	154	129	103	77.2	17.7	11.8	8.87	7.09	
	UC	40	6.00	446	356	297	223	178	149	119	89.1	20.5	13.6	10.2	8.18	
	UC	50	6.71	498	399	332	249	199	166	133	99.6	22.9	15.3	11.4	9.15	
	XC	60	7.35	546	437	364	273	218	182	146	109	25.1	16.7	12.5	10.0	
	XC	70	7.94	590	472	393	295	236	197	157	118	27.1	18.1	13.5	10.8	
60	XC	80	8.49	630	504	420	315	252	210	168	126	29.0	19.3	14.5	11.6	

Droplet size based on ASABE S572.1 standard.

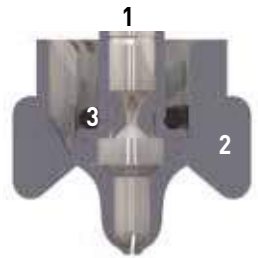

1. Straight flow design for superior resistance to plugging and creation of driftable droplets
2. Unitized spray nozzle design for easy single piece operation
3. Removable pre-orifice for easy cleaning



## Floater Adapter for Hi-Flow Nozzles

Part Number	Description
9950-0001	Floater Adapter Kit for Hi-Flow Nozzles (3/4" Cam Lock to Bayonet)



140° wide, large droplet spray pattern for industry leading coverage of liquid fertilizers.

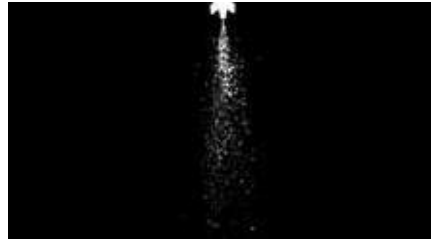

Straight through design squeezes fluid flow to create the spray pattern versus deflecting fluid flow and creating un-needed spray drift.

Metric Units

Nozzle Size	Droplet Size	Pressure (BAR)	Flow Rate (LPM)	Application Rate L/Ha - 50 cm Spacing							
				7	8	10	12	15	20	25	30
08	UC	1,5	2,26	387	339	271	226	181	136	108	90
	UC	2	2,61	447	392	313	261	209	157	125	104
	UC	2,5	2,92	501	438	350	292	234	175	140	117
	UC	3	3,20	549	480	384	320	256	192	154	128
	XC	4	3,70	634	555	444	370	296	222	178	148
	XC	5	4,13	708	620	496	413	330	248	198	165
XC	6	4,53	777	680	544	453	362	272	217	181	
10	UC	1,5	2,8	480	420	336	280	224	168	134	112
	UC	2	3,3	566	495	396	330	264	198	158	132
	UC	2,5	3,7	634	555	444	370	296	222	178	148
	UC	3	4,0	686	600	480	400	320	240	192	160
	XC	4	4,6	789	690	552	460	368	276	221	184
	XC	5	5,2	891	780	624	520	416	312	250	208
XC	6	5,7	977	855	684	570	456	342	274	228	
15	UC	1,5	4,2	720	630	504	420	336	252	202	168
	UC	2	4,9	840	735	588	490	392	294	235	196
	UC	2,5	5,5	943	825	660	550	440	330	264	220
	UC	3	6,0	1029	900	720	600	480	360	288	240
	XC	4	6,9	1183	1035	828	690	552	414	331	276
	XC	5	7,7	1320	1155	924	770	616	462	370	308
XC	6	8,5	1457	1275	1020	850	680	510	408	340	
20	UC	1,5	5,7	977	855	684	570	456	342	274	228
	UC	2	6,5	1114	975	780	650	520	390	312	260
	UC	2,5	7,3	1251	1095	876	730	584	438	350	292
	UC	3	8,0	1371	1200	960	800	640	480	384	320
	XC	4	9,2	1577	1380	1104	920	736	552	442	368
	XC	5	10,3	1766	1545	1236	1030	824	618	494	412
XC	6	11,3	1937	1695	1356	1130	904	678	542	452	
30	UC	1,5	8,5	1457	1275	1020	850	680	510	408	340
	UC	2	9,8	1680	1470	1176	980	784	588	470	392
	UC	2,5	11,0	1886	1650	1320	1100	880	660	528	440
	UC	3	12,0	2057	1800	1440	1200	960	720	576	480
	XC	4	13,9	2383	2085	1668	1390	1112	834	667	556
	XC	5	15,5	2657	2325	1860	1550	1240	930	744	620
XC	6	17,0	2914	2550	2040	1700	1360	1020	816	680	
40	UC	1,5	11,3	1937	1695	1356	1130	904	678	542	452
	UC	2	13,1	2246	1965	1572	1310	1048	786	629	524
	UC	2,5	14,6	2503	2190	1752	1460	1168	876	701	584
	UC	3	16,0	2743	2400	1920	1600	1280	960	768	640
	XC	4	18,5	3171	2775	2220	1850	1480	1110	888	740
	XC	5	20,7	3549	3105	2484	2070	1656	1242	994	828
XC	6	22,6	3874	3390	2712	2260	1808	1356	1085	904	
50	UC	1,5	14,1	2417	2115	1692	1410	1128	846	677	564
	UC	2	16,3	2794	2445	1956	1630	1304	978	782	652
	UC	2,5	18,3	3137	2745	2196	1830	1464	1098	878	732
	UC	3	20,0	3429	3000	2400	2000	1600	1200	960	800
	XC	4	23,1	3960	3465	2772	2310	1848	1386	1109	924
	XC	5	25,8	4423	3870	3096	2580	2064	1548	1238	1032
XC	6	28,3	4851	4245	3396	2830	2264	1698	1358	1132	
60	UC	1,5	17,0	2914	2550	2040	1700	1360	1020	816	680
	UC	2	19,6	3360	2940	2352	1960	1568	1176	941	784
	UC	2,5	21,9	3754	3285	2628	2190	1752	1314	1051	876
	UC	3	24,0	4114	3600	2880	2400	1920	1440	1152	960
	XC	4	27,7	4749	4155	3324	2770	2216	1662	1330	1108
	XC	5	31,0	5314	4650	3720	3100	2480	1860	1488	1240
XC	6	33,9	5811	5085	4068	3390	2712	2034	1627	1356	

Droplet size based on ASABE S572.1 standard.

Features	
Common Use	Fertilizer
Pattern	Tapered Flat Fan
Technology	Pre-Orifice
Material	Polyacetat
Spray Angle	140°
Pressure Range	20-80 PSI (1.5-6 BAR)
Configuration	FastCap
Optimum Boom Height	
15" (35 cm) Spacing	10" (25 cm)
20" (50 cm) Spacing	12" (30 cm)
Part Numbers	
FastCaps 140°	
HF140-08	
HF140-10	
HF140-15	
HF140-20	
HF140-30	
HF140-40	
HF140-50	
HF140-60	
Replacement Cap Gasket	
65-BS205	



# DeflecTip 80°-160°



The DeflecTip wide-angle flood fan nozzle creates a wide pattern at very low pressures while creating mainly medium and coarse droplets. It is well suited for mounting on machinery where a wide angle or a low spray height is desired and on sprayers using very low pressures, including manual sprayers.

- Sprays at very low pressures
- Medium to coarse spray is suited for a variety of applications
- Larger sizes are suitable for liquid fertilizer applications
- Large circular orifice reduces the chances of blocking
- For use of single nozzles with knapsack/backpack sprayers (See page 200)

### US Units

Nozzle Size	Droplet Size	Spray Angle @45 psi	Pressure (PSI)	Flow Rate (GPM)	Gallons per Acre 20 inch nozzle spacing							GAL/1000ft <sup>2</sup>				
					4	5	6	8	10	12	15	20	20 inch nozzle spacing			
0.5	VC	80°	10	0.05	3.7	3.0	2.5	1.9	1.5	1.2	1.0	0.7	0.17	0.11	0.09	0.07
	M				5.3	4.2	3.5	2.6	2.1	1.8	1.4	1.1	0.24	0.16	0.12	0.10
	F				6.4	5.1	4.3	3.2	2.6	2.1	1.7	1.3	0.30	0.20	0.15	0.12
	F				7.4	5.9	5.0	3.7	3.0	2.5	2.0	1.5	0.34	0.23	0.17	0.14
	F				8.3	6.6	5.5	4.2	3.3	2.8	2.2	1.7	0.38	0.25	0.19	0.15
	F				9.1	7.3	6.1	4.5	3.6	3.0	2.4	1.8	0.42	0.28	0.21	0.17
0.75	XC	95°	10	0.08	5.6	4.5	3.7	2.8	2.2	1.9	1.5	1.1	0.26	0.17	0.13	0.10
	M				7.9	6.3	5.3	3.9	3.2	2.6	2.1	1.6	0.36	0.24	0.18	0.14
	M				9.6	7.7	6.4	4.8	3.9	3.2	2.6	1.9	0.44	0.30	0.22	0.18
	F				11.1	8.9	7.4	5.6	4.5	3.7	3.0	2.2	0.51	0.34	0.26	0.20
	F				12.5	10.0	8.3	6.2	5.0	4.2	3.3	2.5	0.57	0.38	0.29	0.23
	F				13.6	10.9	9.1	6.8	5.5	4.5	3.6	2.7	0.63	0.42	0.31	0.25
1.0	C	105°	10	0.10	7.4	5.9	5.0	3.7	3.0	2.5	2.0	1.5	0.34	0.23	0.17	0.14
	M				10.5	8.4	7.0	5.3	4.2	3.5	2.8	2.1	0.48	0.32	0.24	0.19
	F				12.9	10.3	8.6	6.4	5.1	4.3	3.4	2.6	0.59	0.39	0.30	0.24
	F				14.9	11.9	9.9	7.4	5.9	5.0	4.0	3.0	0.68	0.45	0.34	0.27
	F				16.6	13.3	11.1	8.3	6.6	5.5	4.4	3.3	0.76	0.51	0.38	0.30
	F				18.2	14.5	12.1	9.1	7.3	6.1	4.8	3.6	0.84	0.56	0.42	0.33
1.5	VC	105°	10	0.15	11.1	8.9	7.4	5.6	4.5	3.7	3.0	2.2	0.51	0.34	0.26	0.20
	M				15.8	12.6	10.5	7.9	6.3	5.3	4.2	3.2	0.72	0.48	0.36	0.29
	M				19.3	15.4	12.9	9.6	7.7	6.4	5.1	3.9	0.89	0.59	0.44	0.35
	F				22.3	17.8	14.9	11.1	8.9	7.4	5.9	4.5	1.02	0.68	0.51	0.41
	F				24.9	19.9	16.6	12.5	10.0	8.3	6.6	5.0	1.14	0.76	0.57	0.46
	F				27.3	21.8	18.2	13.6	10.9	9.1	7.3	5.5	1.25	0.84	0.63	0.50
2.0	M	105°	10	0.20	14.9	11.9	9.9	7.4	5.9	5.0	4.0	3.0	0.68	0.45	0.34	0.27
	M				21.0	16.8	14.0	10.5	8.4	7.0	5.6	4.2	0.96	0.64	0.48	0.39
	M				25.7	20.6	17.1	12.9	10.3	8.6	6.9	5.1	1.18	0.79	0.59	0.47
	F				29.7	23.8	19.8	14.9	11.9	9.9	7.9	5.9	1.36	0.91	0.68	0.55
	F				33.2	26.6	22.1	16.6	13.3	11.1	8.9	6.6	1.52	1.02	0.76	0.61
	F				36.4	29.1	24.2	18.2	14.5	12.1	9.7	7.3	1.67	1.11	0.84	0.67
2.5	C	110°	10	0.25	18.6	14.9	12.4	9.3	7.4	6.2	5.0	3.7	0.85	0.57	0.43	0.34
	M				26.3	21.0	17.5	13.1	10.5	8.8	7.0	5.3	1.21	0.80	0.60	0.48
	M				32.2	25.7	21.4	16.1	12.9	10.7	8.6	6.4	1.48	0.98	0.74	0.59
	M				37.1	29.7	24.8	18.6	14.9	12.4	9.9	7.4	1.70	1.14	0.85	0.68
	F				41.5	33.2	27.7	20.8	16.6	13.8	11.1	8.3	1.91	1.27	0.95	0.76
	F				45.5	36.4	30.3	22.7	18.2	15.2	12.1	9.1	2.09	1.39	1.04	0.84
3.0	C	110°	10	0.30	22.3	17.8	14.9	11.1	8.9	7.4	5.9	4.5	1.02	0.68	0.51	0.41
	M				31.5	25.2	21.0	15.8	12.6	10.5	8.4	6.3	1.45	0.96	0.72	0.58
	M				38.6	30.9	25.7	19.3	15.4	12.9	10.3	7.7	1.77	1.18	0.89	0.71
	M				44.6	35.6	29.7	22.3	17.8	14.9	11.9	8.9	2.05	1.36	1.02	0.82
	M				49.8	39.8	33.2	24.9	19.9	16.6	13.3	10.0	2.29	1.52	1.14	0.91
	M				54.6	43.6	36.4	27.3	21.8	18.2	14.5	10.9	2.51	1.67	1.25	1.00
4.0	M	120°	10	0.40	29.7	23.8	19.8	14.9	11.9	9.9	7.9	5.9	1.36	0.91	0.68	0.55
	M				42.0	33.6	28.0	21.0	16.8	14.0	11.2	8.4	1.93	1.29	0.96	0.77
	M				51.4	41.2	34.3	25.7	20.6	17.1	13.7	10.3	2.36	1.57	1.18	0.94
	M				59.4	47.5	39.6	29.7	23.8	19.8	15.8	11.9	2.73	1.82	1.36	1.09
	M				66.4	53.1	44.3	33.2	26.6	22.1	17.7	13.3	3.05	2.03	1.52	1.22
	F				72.7	58.2	48.5	36.4	29.1	24.2	19.4	14.5	3.34	2.23	1.67	1.34
5.0	M	125°	10	0.50	37.1	29.7	24.8	18.6	14.9	12.4	9.9	7.4	1.70	1.14	0.85	0.68
	M				52.5	42.0	35.0	26.3	21.0	17.5	14.0	10.5	2.41	1.61	1.21	0.96
	M				64.3	51.4	42.9	32.2	25.7	21.4	17.1	12.9	2.95	1.97	1.48	1.18
	M				74.3	59.4	49.5	37.1	29.7	24.8	19.8	14.9	3.41	2.27	1.70	1.36
	F				83.0	66.4	55.3	41.5	33.2	27.7	22.1	16.6	3.81	2.54	1.91	1.52
	F				90.9	72.7	60.6	45.5	36.4	30.3	24.2	18.2	4.18	2.78	2.09	1.67
7.5	C	145°	10	0.75	55.7	44.6	37.1	27.8	22.3	18.6	14.9	11.1	2.56	1.70	1.28	1.02
	C				78.8	63.0	52.5	39.4	31.5	26.3	21.0	15.8	3.62	2.41	1.81	1.45
	C				96.5	77.2	64.3	48.2	38.6	32.2	25.7	19.3	4.43	2.95	2.21	1.77
	C				111.4	89.1	74.3	55.7	44.6	37.1	29.7	22.3	5.11	3.41	2.56	2.05
	C				124.5	99.6	83.0	62.3	49.8	41.5	33.2	24.9	5.72	3.81	2.86	2.29
	M				136.4	109.1	90.9	68.2	54.6	45.5	36.4	27.3	6.26	4.18	3.13	2.51
10	C	160°	10	1.00	74.3	59.4	49.5	37.1	29.7	24.8	19.8	14.9	3.41	2.27	1.70	1.36
	M				105.0	84.0	70.0	52.5	42.0	35.0	28.0	21.0	4.82	3.21	2.41	1.93
	M				128.6	102.9	85.7	64.3	51.4	42.9	34.3	25.7	5.90	3.94	2.95	2.36
	M				148.5	118.8	99.0	74.3	59.4	49.5	39.6	29.7	6.82	4.55	3.41	2.73
	M				166.0	132.8	110.7	83.0	66.4	55.3	44.3	33.2	7.62	5.08	3.81	3.05
	F				181.9	145.5	121.2	90.9	72.7	60.6	48.5	36.4	8.35	5.57	4.18	3.34
15	C	145°	10	1.50	111.4	89.1	74.3	55.7	44.6	37.1	29.7	22.3	5.11	3.41	2.56	2.05
	C				157.5	126.0	105.0	78.8	63.0	52.5	42.0	31.5	7.23	4.82	3.62	2.89
	C				192.9	154.3	128.6	96.5	77.2	64.3	51.4	38.6	8.86	5.90	4.43	3.54
	C				222.8	178.2	148.5	111.4	89.1	74.3	59.4	44.6	10.23	6.82	5.11	4.09
	C				249.0	199.2	166.0	124.5	99.6	83.0	66.4	49.8	11.43	7.62	5.72	4.57
	M				272.8	218.2	181.9	136.4	109.1	90.9	72.7	54.6	12.53	8.35	6.26	5.01
20	VC	140°	10	2.00	148.5	118.8	99.0	74.3	59.4	49.5	39.6	29.7	6.82	4.55	3.41	2.73
	C				210.0	168.0	140.0	105.0	84.0	70.0	56.0	42.0	9.64	6.43	4.82	3.86
	C				257.2	205.8	171.5	128.6	102.9	85.7	68.6	51.4	11.81	7.87	5.90	4.72
	C				297.0	237.6	198.0	148.5	118.8	99.0	79.2	59.4	13.64	9.09	6.82	5.45
	C				332.1	265.6	221.4	166.0	132.8	110.7	88.5	66.4	15.25	10.16	7.62	6.10
	C				363.7	291.0	242.5	181.9	145.5	121.2	97.0	72.7	16.70	11.13	8.35	6.68

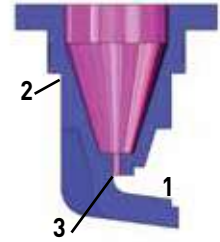

1. Simple; deflecting spray pattern
2. Polyacetal; single piece design
3. Available in many sizes to meet your flow rate needs

**Metric Units**

Nozzle Size	Droplet Size	Spray Angle @ 3 bar	Pressure [BAR]	Flow Rate [LPM]	Application Rate L/Ha - 50 cm Spacing KM/H							
					7	8	10	12	15	20	25	30
0.5	VC	80°	1.0	0.23	39	34	27	23	18	14	11	9
	M		1.5	0.28	48	42	34	28	22	17	13	11
	F		2.0	0.32	55	48	39	32	26	19	15	13
	F		2.5	0.36	62	54	43	36	29	22	17	14
	F		3.0	0.39	68	59	47	39	32	24	19	16
	F		4.0	0.46	78	68	55	46	36	27	22	18
0.75	XC	95°	1.0	0.34	59	51	41	34	27	21	16	14
	M		1.5	0.42	72	63	50	42	34	25	20	17
	M		2.0	0.48	83	73	58	48	39	29	23	19
	F		2.5	0.54	93	81	65	54	43	32	26	22
	F		3.0	0.59	102	89	71	59	47	36	28	24
	F		4.0	0.68	117	103	82	68	55	41	33	27
1.0	C	105°	1.0	0.46	78	68	55	46	36	27	22	18
	M		1.5	0.56	96	84	67	56	45	34	27	22
	F		2.0	0.64	111	97	77	64	52	39	31	26
	F		2.5	0.72	124	108	86	72	58	43	35	29
	F		3.0	0.79	135	118	95	79	63	47	38	32
	F		4.0	0.91	156	137	109	91	73	55	44	36
1.5	VC	105°	1.0	0.68	117	103	82	68	55	41	33	27
	M		1.5	0.84	144	126	101	84	67	50	40	34
	M		2.0	0.97	166	145	116	97	77	58	46	39
	F		2.5	1.08	185	162	130	108	86	65	52	43
	F		3.0	1.18	203	178	142	118	95	71	57	47
	F		4.0	1.37	234	205	164	137	109	82	66	55
2.0	M	105°	1.0	0.91	156	137	109	91	73	55	44	36
	M		1.5	1.12	191	168	134	112	89	67	54	45
	M		2.0	1.29	221	193	155	129	103	77	62	52
	F		2.5	1.44	247	216	173	144	115	86	69	58
	F		3.0	1.58	271	237	190	158	126	95	76	63
	F		4.0	1.82	313	274	219	182	146	109	88	73
2.5	C	110°	1.0	1.14	195	171	137	114	91	68	55	46
	M		1.5	1.40	239	209	168	140	112	84	67	56
	M		2.0	1.61	276	242	193	161	129	97	77	64
	F		2.5	1.80	309	270	216	180	144	108	86	72
	F		3.0	1.97	338	296	237	197	158	118	95	79
	F		4.0	2.28	391	342	274	228	182	137	109	91
3.0	C	110°	1.0	1.37	234	205	164	137	109	82	66	55
	M		1.5	1.68	287	251	201	168	134	101	80	67
	M		2.0	1.93	332	290	232	193	155	116	93	77
	M		2.5	2.16	371	324	259	216	173	130	104	86
	M		3.0	2.37	406	355	284	237	190	142	114	95
	M		4.0	2.74	469	410	328	274	219	164	131	109
4.0	M	120°	1.0	1.82	313	274	219	182	146	109	88	73
	M		1.5	2.23	383	335	268	223	179	134	107	89
	M		2.0	2.58	442	387	309	258	206	155	124	103
	M		2.5	2.88	494	432	346	288	231	173	138	115
	M		3.0	3.16	541	474	379	316	253	190	152	126
	F		4.0	3.65	625	547	438	365	292	219	175	146
5.0	M	125°	1.0	2.3	391	342	274	228	182	137	109	91
	M		1.5	2.8	479	419	335	279	223	168	134	112
	M		2.0	3.2	553	484	387	322	258	193	155	129
	M		2.5	3.6	618	541	432	360	288	216	173	144
	M		3.0	3.9	677	592	474	395	316	237	190	158
	F		4.0	4.6	782	684	547	456	365	274	219	182
7.5	C	145°	1.0	3.4	586	513	410	342	274	205	164	137
	C		1.5	4.2	718	628	503	419	335	251	201	168
	C		2.0	4.8	829	725	580	484	387	290	232	193
	C		2.5	5.4	927	811	649	541	432	324	259	216
	C		3.0	5.9	1015	888	711	592	474	355	284	237
	M		4.0	6.8	1172	1026	821	684	547	410	328	274
10	C	160°	1.0	4.6	782	684	547	456	365	274	219	182
	M		1.5	5.6	957	838	670	558	447	335	268	223
	M		2.0	6.4	1105	967	774	645	516	387	309	258
	M		2.5	7.2	1236	1081	865	721	577	432	346	288
	M		3.0	7.9	1354	1184	948	790	632	474	379	316
	M		4.0	9.1	1563	1368	1094	912	729	547	438	365
15	C	145°	1.0	6.8	1172	1026	821	684	547	410	328	274
	C		1.5	8.4	1436	1256	1005	838	670	503	402	335
	C		2.0	9.7	1658	1451	1160	967	774	580	464	387
	C		2.5	10.8	1854	1622	1297	1081	865	649	519	432
	M		3.0	11.8	2030	1777	1421	1184	948	711	569	474
	M		4.0	13.7	2345	2051	1641	1368	1094	821	656	547
20	VC	140°	1.0	9.1	1563	1368	1094	912	729	547	438	365
	C		1.5	11.2	1914	1675	1340	1117	893	670	536	447
	C		2.0	12.9	2210	1934	1547	1289	1032	774	619	516
	C		2.5	14.4	2471	2162	1730	1442	1153	865	692	577
	C		3.0	15.8	2707	2369	1895	1579	1263	948	758	632
	C		4.0	18.2	3126	2735	2188	1824	1459	1094	875	729

Droplet size based on ASABE S572.1 standard.

Features	
Common Use	Weeds & Fertilizer
Pattern	Flood
Technology	Deflection
Material	Polyacetal
Spray Angle	80°-160°
Pressure Range	10-60 PSI (1-3 BAR)
Configuration	Nozzle
Part Numbers	
Nozzles	Caps (25 Pack)
30DT0.5	CAP30-20
30DT0.75	CAP30-20
30DT1.0	CAP30-20
30DT1.5	CAP30-20
30DT2.0	CAP30-20
30DT2.5	CAP30-20
30DT3.0	CAP30-20
30DT4.0	CAP30-20
30DT5.0	CAP30-20
30DT7.5	CAP30-20
30DT15	CAP30-20
30DT20	CAP30-20



# Ceramic APM 80°-160°



The Albuz® APM wide-angle flood fan nozzle creates a wide pattern at very low pressures while creating mainly medium and coarse droplets. It is well suited for mounting on machinery where a wide angle or a low spray height is desired and on sprayers using very low pressures, including manual sprayers. The ceramic orifice and deflector make the APM the longest-wearing flood nozzle.

- Sprays at very low pressures
- Medium to coarse spray is suited for a variety of applications
- Large round orifice resists plugging
- Wear-resistant Albuz® ceramic orifice and deflector

## US Units

Nozzle Size	Droplet Size	Spray Angle @ 30 PSI	Pressure (PSI)	Flow Rate (GPM)	Gallons per Acre 20 inch nozzle spacing								GAL/1000ft <sup>2</sup>			
					MPH								20 inch nozzle spacing			
					4	5	6	8	10	12	15	20	2	3	4	5
0.12	M	80°	10	0.12	4.5	3.6	3.0	2.2	1.8	1.5	1.2	0.9	0.41	0.27	0.20	0.16
	M		20	0.17	6.3	5.0	4.2	3.2	2.5	2.1	1.7	1.3	0.58	0.39	0.29	0.23
	M		30	0.21	7.8	6.2	5.2	3.9	3.1	2.6	2.1	1.6	0.72	0.48	0.36	0.29
	M		40	0.24	8.9	7.1	5.9	4.5	3.6	3.0	2.4	1.8	0.82	0.55	0.41	0.33
	M		50	0.27	10.0	8.0	6.7	5.0	4.0	3.3	2.7	2.0	0.92	0.61	0.46	0.37
M	60	0.29	10.8	8.6	7.2	5.4	4.3	3.6	2.9	2.2	0.99	0.66	0.49	0.40		
0.2	M	110°	10	0.20	7.4	5.9	5.0	3.7	3.0	2.5	2.0	1.5	0.68	0.45	0.34	0.27
	M		20	0.28	10.4	8.3	6.9	5.2	4.2	3.5	2.8	2.1	0.95	0.64	0.48	0.38
	M		30	0.35	13.0	10.4	8.7	6.5	5.2	4.3	3.5	2.6	1.19	0.80	0.60	0.48
	M		40	0.40	14.9	11.9	9.9	7.4	5.9	5.0	4.0	3.0	1.36	0.91	0.68	0.55
	M		50	0.45	16.7	13.4	11.1	8.4	6.7	5.6	4.5	3.3	1.53	1.02	0.77	0.61
M	60	0.49	18.2	14.6	12.1	9.1	7.3	6.1	4.9	3.6	1.67	1.11	0.84	0.67		
0.3	C	125°	10	0.30	11.1	8.9	7.4	5.6	4.5	3.7	3.0	2.2	1.02	0.68	0.51	0.41
	C		20	0.42	15.6	12.5	10.4	7.8	6.2	5.2	4.2	3.1	1.43	0.95	0.72	0.57
	M		30	0.52	19.3	15.4	12.9	9.7	7.7	6.4	5.1	3.9	1.77	1.18	0.89	0.71
	M		40	0.60	22.3	17.8	14.9	11.1	8.9	7.4	5.9	4.5	2.05	1.36	1.02	0.82
	M		50	0.67	24.9	19.9	16.6	12.4	9.9	8.3	6.6	5.0	2.28	1.52	1.14	0.91
M	60	0.73	27.1	21.7	18.1	13.6	10.8	9.0	7.2	5.4	2.49	1.66	1.24	1.00		
0.4	C	135°	10	0.40	14.9	11.9	9.9	7.4	5.9	5.0	4.0	3.0	1.36	0.91	0.68	0.55
	C		20	0.57	21.2	16.9	14.1	10.6	8.5	7.1	5.6	4.2	1.94	1.30	0.97	0.78
	M		30	0.69	25.6	20.5	17.1	12.8	10.2	8.5	6.8	5.1	2.35	1.57	1.18	0.94
	M		40	0.80	29.7	23.8	19.8	14.9	11.9	9.9	7.9	5.9	2.73	1.82	1.36	1.09
	M		50	0.89	33.0	26.4	22.0	16.5	13.2	11.0	8.8	6.6	3.03	2.02	1.52	1.21
M	60	0.98	36.4	29.1	24.3	18.2	14.6	12.1	9.7	7.3	3.34	2.23	1.67	1.34		
0.5	C	140°	10	0.50	18.6	14.9	12.4	9.3	7.4	6.2	5.0	3.7	1.71	1.14	0.85	0.68
	C		20	0.71	26.4	21.1	17.6	13.2	10.5	8.8	7.0	5.3	2.42	1.61	1.21	0.97
	M		30	0.87	32.3	25.8	21.5	16.1	12.9	10.8	8.6	6.5	2.97	1.98	1.48	1.19
	M		40	1.00	37.1	29.7	24.8	18.6	14.9	12.4	9.9	7.4	3.41	2.27	1.71	1.36
	M		50	1.12	41.6	33.3	27.7	20.8	16.6	13.9	11.1	8.3	3.82	2.55	1.91	1.53
M	60	1.22	45.3	36.2	30.2	22.6	18.1	15.1	12.1	9.1	4.16	2.77	2.08	1.66		
0.74	VC	160°	10	0.70	26.0	20.8	17.3	13.0	10.4	8.7	6.9	5.2	2.39	1.59	1.19	0.95
	C		20	0.99	36.8	29.4	24.5	18.4	14.7	12.3	9.8	7.4	3.38	2.25	1.69	1.35
	C		30	1.21	44.9	35.9	29.9	22.5	18.0	15.0	12.0	9.0	4.13	2.75	2.06	1.65
	C		40	1.40	52.0	41.6	34.7	26.0	20.8	17.3	13.9	10.4	4.77	3.18	2.39	1.91
	C		50	1.57	58.3	46.6	38.9	29.1	23.3	19.4	15.5	11.7	5.35	3.57	2.68	2.14
C	60	1.71	63.5	50.8	42.3	31.7	25.4	21.2	16.9	12.7	5.83	3.89	2.92	2.33		
0.94	VC	160°	10	0.91	33.8	27.0	22.5	16.9	13.5	11.3	9.0	6.8	3.10	2.07	1.55	1.24
	C		20	1.29	47.9	38.3	31.9	23.9	19.2	16.0	12.8	9.6	4.40	2.93	2.20	1.76
	C		30	1.58	58.7	46.9	39.1	29.3	23.5	19.6	15.6	11.7	5.39	3.59	2.69	2.16
	C		40	1.82	67.6	54.1	45.0	33.8	27.0	22.5	18.0	13.5	6.21	4.14	3.10	2.48
	C		50	2.03	75.4	60.3	50.2	37.7	30.1	25.1	20.1	15.1	6.92	4.61	3.46	2.77
C	60	2.23	82.8	66.2	55.2	41.4	33.1	27.6	22.1	16.6	7.60	5.07	3.80	3.04		

Droplet size based on ASABE S572.1 standard.

**Metric Units**

Nozzle Size	Droplet Size	Spray Angle @ 2 bar	Pressure (Bar)	Flow Rate (LPM)	Liters/Hectare 100 cm nozzle spacing									
					6	8	10	12	14	16	17	20	25	30
0.12	M	80°	0.5	0.39	39.0	29.3	23.4	19.5	16.7	14.6	13.0	11.7	9.4	7.8
			1	0.55	55.0	41.3	33.0	27.5	23.6	20.6	18.3	16.5	13.2	11.0
			1.5	0.67	67.0	50.3	40.2	33.5	28.7	25.1	22.3	20.1	16.1	13.4
			2	0.78	78.0	58.5	46.8	39.0	33.4	29.3	26.0	23.4	18.7	15.6
			2.5	0.87	87.0	65.3	52.2	43.5	37.3	32.6	29.0	26.1	20.9	17.4
			3	0.95	95.0	71.3	57.0	47.5	40.7	35.6	31.7	28.5	22.8	19.0
			3.5	1.03	103.0	77.3	61.8	51.5	44.1	38.6	34.3	30.9	24.7	20.6
4	1.1	110.0	82.5	66.0	55.0	47.1	41.3	36.7	33.0	26.4	22.0			
0.2	M	110°	0.5	0.64	64.0	48.0	38.4	32.0	27.4	24.0	21.3	19.2	15.4	12.8
			1	0.91	91.0	68.3	54.6	45.5	39.0	34.1	30.3	27.3	21.8	18.2
			1.5	1.12	112.0	84.0	67.2	56.0	48.0	42.0	37.3	33.6	26.9	22.4
			2	1.29	129.0	96.8	77.4	64.5	55.3	48.4	43.0	38.7	31.0	25.8
			2.5	1.44	144.0	108.0	86.4	72.0	61.7	54.0	48.0	43.2	34.6	28.8
			3	1.58	158.0	118.5	94.8	79.0	67.7	59.3	52.7	47.4	37.9	31.6
			3.5	1.71	171.0	128.3	102.6	85.5	73.3	64.1	57.0	51.3	41.0	34.2
4	1.82	182.0	136.5	109.2	91.0	78.0	68.3	60.7	54.6	43.7	36.4			
0.3	C	125°	0.5	0.97	97.0	72.8	58.2	48.5	41.6	36.4	32.3	29.1	23.3	19.4
			1	1.37	137.0	102.8	82.2	68.5	58.7	51.4	45.7	41.1	32.9	27.4
			1.5	1.68	168.0	126.0	100.8	84.0	72.0	63.0	56.0	50.4	40.3	33.6
	M		2	1.94	194.0	145.5	116.4	97.0	83.1	72.8	64.7	58.2	46.6	38.8
			2.5	2.17	217.0	162.8	130.2	108.5	93.0	81.4	72.3	65.1	52.1	43.4
			3	2.38	238.0	178.5	142.8	119.0	102.0	89.3	79.3	71.4	57.1	47.6
			3.5	2.57	257.0	192.8	154.2	128.5	110.1	96.4	85.7	77.1	61.7	51.4
4	2.74	274.0	205.5	164.4	137.0	117.4	102.8	91.3	82.2	65.8	54.8			
0.4	C	135°	0.5	1.3	130.0	97.5	78.0	65.0	55.7	48.8	43.3	39.0	31.2	26.0
			1	1.84	184.0	138.0	110.4	92.0	78.9	69.0	61.3	55.2	44.2	36.8
			1.5	2.25	225.0	168.8	135.0	112.5	96.4	84.4	75.0	67.5	54.0	45.0
	M		2	2.6	260.0	195.0	156.0	130.0	111.4	97.5	86.7	78.0	62.4	52.0
			2.5	2.9	290.0	217.5	174.0	145.0	124.3	108.8	96.7	87.0	69.6	58.0
			3	3.18	318.0	238.5	190.8	159.0	136.3	119.3	106.0	95.4	76.3	63.6
			3.5	3.43	343.0	257.3	205.8	171.5	147.0	128.6	114.3	102.9	82.3	68.6
4	3.68	368.0	276.0	220.8	184.0	157.7	138.0	122.7	110.4	88.3	73.6			
0.5	C	140°	0.5	1.62	162.0	121.5	97.2	81.0	69.4	60.8	54.0	48.6	38.9	32.4
			1	2.29	229.0	171.8	137.4	114.5	98.1	85.9	76.3	68.7	55.0	45.8
			1.5	2.8	280.0	210.0	168.0	140.0	120.0	105.0	93.3	84.0	67.2	56.0
	M		2	3.23	323.0	242.3	193.8	161.5	138.4	121.1	107.7	96.9	77.5	64.6
			2.5	3.61	361.0	270.8	216.6	180.5	154.7	135.4	120.3	108.3	86.6	72.2
			3	3.96	396.0	297.0	237.6	198.0	169.7	148.5	132.0	118.8	95.0	79.2
			3.5	4.28	428.0	321.0	256.8	214.0	183.4	160.5	142.7	128.4	102.7	85.6
4	4.58	458.0	343.5	274.8	229.0	196.3	171.8	152.7	137.4	109.9	91.6			
0.7	VC	160°	0.5	2.3	230.0	172.5	138.0	115.0	98.6	86.3	76.7	69.0	55.2	46.0
			1	3.25	325.0	243.8	195.0	162.5	139.3	121.9	108.3	97.5	78.0	65.0
			1.5	3.98	398.0	298.5	238.8	199.0	170.6	149.3	132.7	119.4	95.5	79.6
	C		2	4.6	460.0	345.0	276.0	230.0	197.1	172.5	153.3	138.0	110.4	92.0
			2.5	5.14	514.0	385.5	308.4	257.0	220.3	192.8	171.3	154.2	123.4	102.8
			3	5.63	563.0	422.3	337.8	281.5	241.3	211.1	187.7	168.9	135.1	112.6
			3.5	6.08	608.0	456.0	364.8	304.0	260.6	228.0	202.7	182.4	145.9	121.6
4	6.5	650.0	487.5	390.0	325.0	278.6	243.8	216.7	195.0	156.0	130.0			
0.91	VC	160°	0.5	3	300.0	225.0	180.0	150.0	128.6	112.5	100.0	90.0	72.0	60.0
			1	4.24	424.0	318.0	254.4	212.0	181.7	159.0	141.3	127.2	101.8	84.8
			1.5	5.19	519.0	389.3	311.4	259.5	222.4	194.6	173.0	155.7	124.6	103.8
	C		2	6	600.0	450.0	360.0	300.0	257.1	225.0	200.0	180.0	144.0	120.0
			2.5	6.7	670.0	502.5	402.0	335.0	287.1	251.3	223.3	201.0	160.8	134.0
			3	7.35	735.0	551.3	441.0	367.5	315.0	275.6	245.0	220.5	176.4	147.0
			3.5	7.93	793.0	594.8	475.8	396.5	339.9	297.4	264.3	237.9	190.3	158.6
4	8.48	848.0	636.0	508.8	424.0	363.4	318.0	282.7	254.4	203.5	169.6			

Droplet size based on ASABE S572.1 standard.

Features	
Common Use	Weeds & Fertilizer
Pattern	Flood
Technology	Deflection
Material	Ceramic
Spray Angle	80° - 160°
Pressure Range	10-60 PSI (1-4 BAR)
Configuration	Nozzles
Part Numbers	
Nozzles	Caps (25 Pack)
APM-YELLOW	CAP04-20
APM-ORANGE	CAP04-20
APM-RED	CAP04-20
APM-GREEN	CAP04-20
APM-BLUE	CAP04-20
APM-GRAY	CAP04-20
APM-BLACK	CAP04-20



# ESI Six Stream



The ESI six stream nozzle is designed for applying liquid fertilizer. It creates six individual streams that distribute the fertilizer on the soil while getting less on the crop. The wear resistant metering orifice and unique low pressure distribution chamber keep the streams stable to reduce atomization and prevent leaf burn and scorching. Spacing and spray height is similar to 110° broadcast nozzles.

- Six streams distribute fertilizer more evenly than one single stream
- Wear-resistant orifice for long product life
- FastCap includes nozzle, cap and gasket

## US Units

Nozzle Size	Pressure (PSI)	Flow Rate (GPM)	Gallons per Acre 20 inch nozzle spacing								GAL/1000ft <sup>2</sup>				
			MPH								20 inch nozzle spacing				
			4	5	6	8	10	12	15	20	2	3	4	5	
015	15	0.09									0.31	0.20	0.15	0.12	
	20	0.11	8.2	6.5	5.4	4.1	3.3	2.7	2.2	1.6	0.38	0.25	0.19	0.15	
	30	0.13	9.7	7.7	6.4	4.8	3.9	3.2	2.6	1.9	0.44	0.30	0.22	0.18	
	40	0.15	11.1	8.9	7.4	5.6	4.5	3.7	3.0	2.2	0.51	0.34	0.26	0.20	
	50	0.17	12.6	10.1	8.4	6.3	5.0	4.2	3.4	2.5	0.58	0.39	0.29	0.23	
	60	0.18	13.4	10.7	8.9	6.7	5.3	4.5	3.6	2.7	0.61	0.41	0.31	0.25	
02	15	0.12	8.9	7.1	5.9	4.5	3.6	3.0	2.4	1.8	0.41	0.27	0.20	0.16	
	20	0.14	10.4	8.3	6.9	5.2	4.2	3.5	2.8	2.1	0.48	0.32	0.24	0.19	
	30	0.17	12.6	10.1	8.4	6.3	5.0	4.2	3.4	2.5	0.58	0.39	0.29	0.23	
	40	0.20	14.9	11.9	9.9	7.4	5.9	5.0	4.0	3.0	0.68	0.45	0.34	0.27	
	50	0.22	16.3	13.1	10.9	8.2	6.5	5.4	4.4	3.3	0.75	0.50	0.38	0.30	
	60	0.24	17.8	14.3	11.9	8.9	7.1	5.9	4.8	3.6	0.82	0.55	0.41	0.33	
025	15	0.15	11.1	8.9	7.4	5.6	4.5	3.7	3.0	2.2	0.51	0.34	0.26	0.20	
	20	0.18	13.4	10.7	8.9	6.7	5.3	4.5	3.6	2.7	0.61	0.41	0.31	0.25	
	30	0.22	16.3	13.1	10.9	8.2	6.5	5.4	4.4	3.3	0.75	0.50	0.38	0.30	
	40	0.25	18.6	14.9	12.4	9.3	7.4	6.2	5.0	3.7	0.85	0.57	0.43	0.34	
	50	0.28	20.8	16.6	13.9	10.4	8.3	6.9	5.5	4.2	0.95	0.64	0.48	0.38	
	60	0.31	23.0	18.4	15.3	11.5	9.2	7.7	6.1	4.6	1.06	0.70	0.53	0.42	
03	15	0.18	13.4	10.7	8.9	6.7	5.3	4.5	3.6	2.7	0.61	0.41	0.31	0.25	
	20	0.21	15.6	12.5	10.4	7.8	6.2	5.2	4.2	3.1	0.72	0.48	0.36	0.29	
	30	0.26	19.3	15.4	12.9	9.7	7.7	6.4	5.1	3.9	0.89	0.59	0.44	0.35	
	40	0.30	22.3	17.8	14.9	11.1	8.9	7.4	5.9	4.5	1.02	0.68	0.51	0.41	
	50	0.34	25.2	20.2	16.8	12.6	10.1	8.4	6.7	5.0	1.16	0.77	0.58	0.46	
	60	0.37	27.5	22.0	18.3	13.7	11.0	9.2	7.3	5.5	1.26	0.84	0.63	0.50	
04	15	0.24	17.8	14.3	11.9	8.9	7.1	5.9	4.8	3.6	0.82	0.55	0.41	0.33	
	20	0.28	20.8	16.6	13.9	10.4	8.3	6.9	5.5	4.2	0.95	0.64	0.48	0.38	
	30	0.35	26.0	20.8	17.3	13.0	10.4	8.7	6.9	5.2	1.19	0.80	0.60	0.48	
	40	0.40	29.7	23.8	19.8	14.9	11.9	9.9	7.9	5.9	1.36	0.91	0.68	0.55	
	50	0.45	33.4	26.7	22.3	16.7	13.4	11.1	8.9	6.7	1.53	1.02	0.77	0.61	
	60	0.49	36.4	29.1	24.3	18.2	14.6	12.1	9.7	7.3	1.67	1.11	0.84	0.67	
05	15	0.31	23.0	18.4	15.3	11.5	9.2	7.7	6.1	4.6	1.06	0.70	0.53	0.42	
	20	0.35	26.0	20.8	17.3	13.0	10.4	8.7	6.9	5.2	1.19	0.80	0.60	0.48	
	30	0.43	31.9	25.5	21.3	16.0	12.8	10.6	8.5	6.4	1.47	0.98	0.73	0.59	
	40	0.50	37.1	29.7	24.8	18.6	14.9	12.4	9.9	7.4	1.71	1.14	0.85	0.68	
	50	0.56	41.6	33.3	27.7	20.8	16.6	13.9	11.1	8.3	1.91	1.27	0.95	0.76	
	60	0.61	45.3	36.2	30.2	22.6	18.1	15.1	12.1	9.1	2.08	1.39	1.04	0.83	
06	15	0.37	27.5	22.0	18.3	13.7	11.0	9.2	7.3	5.5	1.26	0.84	0.63	0.50	
	20	0.42	31.2	24.9	20.8	15.6	12.5	10.4	8.3	6.2	1.43	0.95	0.72	0.57	
	30	0.52	38.6	30.9	25.7	19.3	15.4	12.9	10.3	7.7	1.77	1.18	0.89	0.71	
	40	0.60	44.6	35.6	29.7	22.3	17.8	14.9	11.9	8.9	2.05	1.36	1.02	0.82	
	50	0.67	49.7	39.8	33.2	24.9	19.9	16.6	13.3	9.9	2.28	1.52	1.14	0.91	
	60	0.73	54.2	43.4	36.1	27.1	21.7	18.1	14.5	10.8	2.49	1.66	1.24	1.00	
08	15	0.49	36.4	29.1	24.3	18.2	14.6	12.1	9.7	7.3	1.67	1.11	0.84	0.67	
	20	0.57	42.3	33.9	28.2	21.2	16.9	14.1	11.3	8.5	1.94	1.30	0.97	0.78	
	30	0.69	51.2	41.0	34.2	25.6	20.5	17.1	13.7	10.2	2.35	1.57	1.18	0.94	
	40	0.80	59.4	47.5	39.6	29.7	23.8	19.8	15.8	11.9	2.73	1.82	1.36	1.09	
	50	0.89	66.1	52.9	44.1	33.0	26.4	22.0	17.6	13.2	3.03	2.02	1.52	1.21	
	60	0.98	72.8	58.2	48.5	36.4	29.1	24.3	19.4	14.6	3.34	2.23	1.67	1.34	
10	15	0.61	45.3	36.2	30.2	22.6	18.1	15.1	12.1	9.1	2.08	1.39	1.04	0.83	
	20	0.71	52.7	42.2	35.1	26.4	21.1	17.6	14.1	10.5	2.42	1.61	1.21	0.97	
	30	0.87	64.6	51.7	43.1	32.3	25.8	21.5	17.2	12.9	2.97	1.98	1.48	1.19	
	40	1.00	74.3	59.4	49.5	37.1	29.7	24.8	19.8	14.9	3.41	2.27	1.71	1.36	
	50	1.12	83.2	66.5	55.4	41.6	33.3	27.7	22.2	16.6	3.82	2.55	1.91	1.53	
	60	1.22	90.6	72.5	60.4	45.3	36.2	30.2	24.2	18.1	4.16	2.77	2.08	1.66	
15	15	0.92	68.3	54.6	45.5	34.2	27.3	22.8	18.2	13.7	3.14	2.09	1.57	1.25	
	20	1.06	78.7	63.0	52.5	39.4	31.5	26.2	21.0	15.7	3.61	2.41	1.81	1.45	
	30	1.30	96.5	77.2	64.4	48.3	38.6	32.2	25.7	19.3	4.43	2.96	2.22	1.77	
	40	1.50	111	89.1	74.3	55.7	44.6	37.1	29.7	22.3	5.12	3.41	2.56	2.05	
	50	1.68	125	99.8	83.2	62.4	49.9	41.6	33.3	24.9	5.73	3.82	2.86	2.29	
	60	1.84	137	109	91.1	68.3	54.6	45.5	36.4	27.3	6.27	4.18	3.14	2.51	
20	15	1.22	90.6	72.5	60.4	45.3	36.2	30.2	24.2	18.1	4.16	2.77	2.08	1.66	
	20	1.41	105	83.8	69.8	52.3	41.9	34.9	27.9	20.9	4.81	3.21	2.40	1.92	
	30	1.73	128	103	85.6	64.2	51.4	42.8	34.3	25.7	5.90	3.93	2.95	2.36	
	40	2.00	149	119	99.0	74.3	59.4	49.5	39.6	29.7	6.82	4.55	3.41	2.73	
	50	2.24	166	133	111	83.2	66.5	55.4	44.4	33.3	7.64	5.09	3.82	3.06	
	60	2.45	182	146	121	91.0	72.8	60.6	48.5	36.4	8.35	5.57	4.18	3.34	

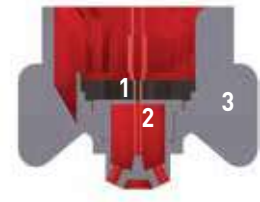

1. Single inlet; Six outlet design for uniform application
2. Pre-orifice; superior product life
3. Available in a FastCap option for easy installation of a streaming nozzle





110° wide pattern consisting of 6 equally spaced streams providing uniform deposition of liquid fertilizers. Each individual stream was engineered to hold stream integrity and not break apart to avoid unwanted fertilizer burn on post emerge applications.

**Metric Units**

Nozzle Size	Pressure [BAR]	Flow Rate [LPM]	Application Rate L/Ha -50 cm Spacing KM/H							
			7	8	10	12	15	20	25	30
015	1	0,35	60	53	42	35	28	21	17	14
	1,5	0,42	72	63	50	42	34	25	20	17
	2	0,49	84	74	59	49	39	29	24	20
	2,5	0,55	94	83	66	55	44	33	26	22
	3	0,60	103	90	72	60	48	36	29	24
4	0,69	118	104	83	69	55	41	33	28	
02	1	0,46	79	69	55	46	37	28	22	18
	1,5	0,57	98	86	68	57	46	34	27	23
	2	0,65	111	98	78	65	52	39	31	26
	2,5	0,73	125	110	88	73	58	44	35	29
	3	0,80	137	120	96	80	64	48	38	32
4	0,92	158	138	110	92	74	55	44	37	
025	1	0,58	99	87	70	58	46	35	28	23
	1,5	0,71	122	107	85	71	57	43	34	28
	2	0,82	141	123	98	82	66	49	39	33
	2,5	0,91	156	137	109	91	73	55	44	36
	3	1,00	171	150	120	100	80	60	48	40
4	1,15	197	173	138	115	92	69	55	46	
03	1	0,69	118	104	83	69	55	41	33	28
	1,5	0,85	146	128	102	85	68	51	41	34
	2	0,98	168	147	118	98	78	59	47	39
	2,5	1,10	189	165	132	110	88	66	53	44
	3	1,20	206	180	144	120	96	72	58	48
4	1,39	238	209	167	139	111	83	67	56	
04	1	0,92	158	138	110	92	74	55	44	37
	1,5	1,13	194	170	136	113	90	68	54	45
	2	1,31	225	197	157	131	105	79	63	52
	2,5	1,46	250	219	175	146	117	88	70	58
	3	1,60	274	240	192	160	128	96	77	64
4	1,85	317	278	222	185	148	111	89	74	
05	1	1,15	197	173	138	115	92	69	55	46
	1,5	1,41	242	212	169	141	113	85	68	56
	2	1,63	279	245	196	163	130	98	78	65
	2,5	1,83	314	275	220	183	146	110	88	73
	3	2,00	343	300	240	200	160	120	96	80
4	2,31	396	347	277	231	185	139	111	92	
06	1	1,39	238	209	167	139	111	83	67	56
	1,5	1,70	291	255	204	170	136	102	82	68
	2	1,96	336	294	235	196	157	118	94	78
	2,5	2,19	375	329	263	219	175	131	105	88
	3	2,40	411	360	288	240	192	144	115	96
4	2,77	475	416	332	277	222	166	133	111	
08	1	1,85	317	278	222	185	148	111	89	74
	1,5	2,26	387	339	271	226	181	136	108	90
	2	2,61	447	392	313	261	209	157	125	104
	2,5	2,92	501	438	350	292	234	175	140	117
	3	3,20	549	480	384	320	256	192	154	128
4	3,70	634	555	444	370	296	222	178	148	
10	1	2,3	394	345	276	230	184	138	110	92
	1,5	2,8	480	420	336	280	224	168	134	112
	2	3,3	566	495	396	330	264	198	158	132
	2,5	3,7	634	555	444	370	296	222	178	148
	3	4,0	686	600	480	400	320	240	192	160
4	4,6	789	690	552	460	368	276	221	184	
15	1	3,5	600	525	420	350	280	210	168	140
	1,5	4,2	720	630	504	420	336	252	202	168
	2	4,9	840	735	588	490	392	294	235	196
	2,5	5,5	943	825	660	550	440	330	264	220
	3	6,0	1029	900	720	600	480	360	288	240
4	6,9	1183	1035	828	690	552	414	331	276	
20	1	4,6	789	690	552	460	368	276	221	184
	1,5	5,7	977	855	684	570	456	342	274	228
	2	6,5	1114	975	780	650	520	390	312	260
	2,5	7,3	1251	1095	876	730	584	438	350	292
	3	8,0	1371	1200	960	800	640	480	384	320
4	9,2	1577	1380	1104	920	736	552	442	368	

Features		
Common Use	Fertilizer	
Pattern	Streams	
Technology	Pre-Orifice	
Material	Ceramic or Polyacetal	
Spray Angle	110° Equivalent	
Pressure Range	15-60 PSI [1-4 BAR]	
Configuration	Nozzle, FastCap	
Optimum Boom Height		
15" (35 cm) Spacing	15" (35 cm)	
20" (50 cm) Spacing	20" (50 cm)	
Part Numbers		
Nozzles 110°	FastCaps 110°	FastCaps 110°
Ceramic Orifice	Ceramic Orifice	Polyacetal Orifice
ESI-110015	FC-ESI-110015*	FC-ESI-110015P
ESI-11002	FC-ESI-11002*	FC-ESI-11002P
ESI-110025	FC-ESI-110025*	-
ESI-11003	FC-ESI-11003*	FC-ESI-11003P
ESI-11004	FC-ESI-11004*	FC-ESI-11004P
ESI-11005	FC-ESI-11005*	FC-ESI-11005P
ESI-11006	FC-ESI-11006*	FC-ESI-11006P
-	FC-ESI-11008	-
-	FC-ESI-11010	-
-	FC-ESI-11015	-
-	-	FC-ESI-11020P
Replacement Cap Gasket		
22W11MF64	Flat seal (sizes 015-06)	
65-BS205	O-ring (sizes 08-15)	

\* Uses flat sealing gasket.



# Fanjet 0°



The 0-degree Fanjet regulates flow, then produces a straight stream pattern. Precision-molded in polyvinylidene fluoride (PVDF) for excellent resistance to acids and many agricultural chemicals.

- 0-degree nozzles provide a single jet of spray for streaming or injecting liquid fertilizer
- Precision-molded using chemically-resistant PVDF material
- Superior resistance to orifice wear compared to brass or stainless steel
- Part number is molded into front of nozzle

## US Units

Nozzle Size	Pressure (PSI)	Flow Rate (GPM)	Gallons per Acre 20 inch nozzle spacing								GAL/1000 <sup>ft</sup>				
			MPH								20 inch nozzle spacing				
			4	5	6	8	10	12	15	20	2	3	4	5	
02	15	0.12	8.9	7.1	5.9	4.5	3.6	3.0	2.4	1.8	0.41	0.27	0.20	0.16	
	20	0.14	10.4	8.3	6.9	5.2	4.2	3.5	2.8	2.1	0.48	0.32	0.24	0.19	
	30	0.17	12.6	10.1	8.4	6.3	5.0	4.2	3.4	2.5	0.58	0.39	0.29	0.23	
	40	0.20	14.9	11.9	9.9	7.4	5.9	5.0	4.0	3.0	0.68	0.45	0.34	0.27	
	50	0.22	16.3	13.1	10.9	8.2	6.5	5.4	4.4	3.3	0.75	0.50	0.38	0.30	
	60	0.24	17.8	14.3	11.9	8.9	7.1	5.9	4.8	3.6	0.82	0.55	0.41	0.33	
03	15	0.18	13.4	10.7	8.9	6.7	5.3	4.5	3.6	2.7	0.61	0.41	0.31	0.25	
	20	0.21	15.6	12.5	10.4	7.8	6.2	5.2	4.2	3.1	0.72	0.48	0.36	0.29	
	30	0.26	19.3	15.4	12.9	9.7	7.7	6.4	5.1	3.9	0.89	0.59	0.44	0.35	
	40	0.30	22.3	17.8	14.9	11.1	8.9	7.4	5.9	4.5	1.02	0.68	0.51	0.41	
	50	0.34	25.2	20.2	16.8	12.6	10.1	8.4	6.7	5.0	1.16	0.77	0.58	0.46	
	60	0.37	27.5	22.0	18.3	13.7	11.0	9.2	7.3	5.5	1.26	0.84	0.63	0.50	
04	15	0.24	17.8	14.3	11.9	8.9	7.1	5.9	4.8	3.6	0.82	0.55	0.41	0.33	
	20	0.28	20.8	16.6	13.9	10.4	8.3	6.9	5.5	4.2	0.95	0.64	0.48	0.38	
	30	0.35	26.0	20.8	17.3	13.0	10.4	8.7	6.9	5.2	1.19	0.80	0.60	0.48	
	40	0.40	29.7	23.8	19.8	14.9	11.9	9.9	7.9	5.9	1.36	0.91	0.68	0.55	
	50	0.45	33.4	26.7	22.3	16.7	13.4	11.1	8.9	6.7	1.53	1.02	0.77	0.61	
	60	0.49	36.4	29.1	24.3	18.2	14.6	12.1	9.7	7.3	1.67	1.11	0.84	0.67	
05	15	0.31	23.0	18.4	15.3	11.5	9.2	7.7	6.1	4.6	1.06	0.70	0.53	0.42	
	20	0.35	26.0	20.8	17.3	13.0	10.4	8.7	6.9	5.2	1.19	0.80	0.60	0.48	
	30	0.43	31.9	25.5	21.3	16.0	12.8	10.6	8.5	6.4	1.47	0.98	0.73	0.59	
	40	0.50	37.1	29.7	24.8	18.6	14.9	12.4	9.9	7.4	1.71	1.14	0.85	0.68	
	50	0.56	41.6	33.3	27.7	20.8	16.6	13.9	11.1	8.3	1.91	1.27	0.95	0.76	
	60	0.61	45.3	36.2	30.2	22.6	18.1	15.1	12.1	9.1	2.08	1.39	1.04	0.83	
06	15	0.37	27.5	22.0	18.3	13.7	11.0	9.2	7.3	5.5	1.26	0.84	0.63	0.50	
	20	0.42	31.2	24.9	20.8	15.6	12.5	10.4	8.3	6.2	1.43	0.95	0.72	0.57	
	30	0.52	38.6	30.9	25.7	19.3	15.4	12.9	10.3	7.7	1.77	1.18	0.89	0.71	
	40	0.60	44.6	35.6	29.7	22.3	17.8	14.9	11.9	8.9	2.05	1.36	1.02	0.82	
	50	0.67	49.7	39.8	33.2	24.9	19.9	16.6	13.3	9.9	2.28	1.52	1.14	0.91	
	60	0.73	54.2	43.4	36.1	27.1	21.7	18.1	14.5	10.8	2.49	1.66	1.24	1.00	
07	15	0.43	31.9	25.5	21.3	16.0	12.8	10.6	8.5	6.4	1.47	0.98	0.73	0.59	
	20	0.49	36.4	29.1	24.3	18.2	14.6	12.1	9.7	7.3	1.67	1.11	0.84	0.67	
	30	0.61	45.3	36.2	30.2	22.6	18.1	15.1	12.1	9.1	2.08	1.39	1.04	0.83	
	40	0.70	52.0	41.6	34.7	26.0	20.8	17.3	13.9	10.4	2.39	1.59	1.19	0.95	
	50	0.78	57.9	46.3	38.6	29.0	23.2	19.3	15.4	11.6	2.66	1.77	1.33	1.06	
	60	0.86	63.9	51.1	42.6	31.9	25.5	21.3	17.0	12.8	2.93	1.96	1.47	1.17	
10	15	0.61	45.3	36.2	30.2	22.6	18.1	15.1	12.1	9.1	2.08	1.39	1.04	0.83	
	20	0.71	52.7	42.2	35.1	26.4	21.1	17.6	14.1	10.5	2.42	1.61	1.21	0.97	
	30	0.87	64.6	51.7	43.1	32.3	25.8	21.5	17.2	12.9	2.97	1.98	1.48	1.19	
	40	1.00	74.3	59.4	49.5	37.1	29.7	24.8	19.8	14.9	3.41	2.27	1.71	1.36	
	50	1.12	83.2	66.5	55.4	41.6	33.3	27.7	22.2	16.6	3.82	2.55	1.91	1.53	
	60	1.22	90.6	72.5	60.4	45.3	36.2	30.2	24.2	18.1	4.16	2.77	2.08	1.66	
15	15	0.92	68.3	54.6	45.5	34.2	27.3	22.8	18.2	13.7	3.14	2.09	1.57	1.25	
	20	1.06	78.7	63.0	52.5	39.4	31.5	26.2	21.0	15.7	3.61	2.41	1.81	1.45	
	30	1.30	96.5	77.2	64.4	48.3	38.6	32.2	25.7	19.3	4.43	2.96	2.22	1.77	
	40	1.50	111	89.1	74.3	55.7	44.6	37.1	29.7	22.3	5.12	3.41	2.56	2.05	
	50	1.68	125	99.8	83.2	62.4	49.9	41.6	33.3	24.9	5.73	3.82	2.86	2.29	
	60	1.84	137	109	91.1	68.3	54.6	45.5	36.4	27.3	6.27	4.18	3.14	2.51	
20	15	1.22	90.6	72.5	60.4	45.3	36.2	30.2	24.2	18.1	4.16	2.77	2.08	1.66	
	20	1.41	105	83.8	69.8	52.3	41.9	34.9	27.9	20.9	4.81	3.21	2.40	1.92	
	30	1.73	128	103	85.6	64.2	51.4	42.8	34.3	25.7	5.90	3.93	2.95	2.36	
	40	2.00	149	119	99.0	74.3	59.4	49.5	39.6	29.7	6.82	4.55	3.41	2.73	
	50	2.24	166	133	111	83.2	66.5	55.4	44.4	33.3	7.64	5.09	3.82	3.06	
	60	2.45	182	146	121	91.0	72.8	60.6	48.5	36.4	8.35	5.57	4.18	3.34	
30	15	1.84	137	109	91.1	68.3	54.6	45.5	36.4	27.3	6.27	4.18	3.14	2.51	
	20	2.12	157	126	105	78.7	63.0	52.5	42.0	31.5	7.23	4.82	3.61	2.89	
	30	2.60	193	154	129	96.5	77.2	64.4	51.5	38.6	8.87	5.91	4.43	3.55	
	40	3.00	223	178	149	111	89.1	74.3	59.4	44.6	10.2	6.82	5.12	4.09	
	50	3.35	249	199	166	124	99.5	82.9	66.3	49.7	11.4	7.62	5.71	4.57	
	60	3.67	272	218	182	136	109	90.8	72.7	54.5	12.5	8.34	6.26	5.01	

**Metric Units**

Nozzle Size	Pressure (BAR)	Flow Rate (LPM)	Application Rate L/Ha - 50 cm Spacing KM/H							
			7	8	10	12	15	20	25	30
02	1	0,46	79	69	55	46	37	28	22	18
	1,5	0,57	98	86	68	57	46	34	27	23
	2	0,65	111	98	78	65	52	39	31	26
	2,5	0,73	125	110	88	73	58	44	35	29
	3	0,80	137	120	96	80	64	48	38	32
4	0,92	158	138	110	92	74	55	44	37	
03	1	0,69	118	104	83	69	55	41	33	28
	1,5	0,85	146	128	102	85	68	51	41	34
	2	0,98	168	147	118	98	78	59	47	39
	2,5	1,10	189	165	132	110	88	66	53	44
	3	1,20	206	180	144	120	96	72	58	48
4	1,39	238	209	167	139	111	83	67	56	
04	1	0,92	158	138	110	92	74	55	44	37
	1,5	1,13	194	170	136	113	90	68	54	45
	2	1,31	225	197	157	131	105	79	63	52
	2,5	1,46	250	219	175	146	117	88	70	58
	3	1,60	274	240	192	160	128	96	77	64
4	1,85	317	278	222	185	148	111	89	74	
05	1	1,15	197	173	138	115	92	69	55	46
	1,5	1,41	242	212	169	141	113	85	68	56
	2	1,63	279	245	196	163	130	98	78	65
	2,5	1,83	314	275	220	183	146	110	88	73
	3	2,00	343	300	240	200	160	120	96	80
4	2,31	396	347	277	231	185	139	111	92	
06	1	1,39	238	209	167	139	111	83	67	56
	1,5	1,70	291	255	204	170	136	102	82	68
	2	1,96	336	294	235	196	157	118	94	78
	2,5	2,19	375	329	263	219	175	131	105	88
	3	2,40	411	360	288	240	192	144	115	96
4	2,77	475	416	332	277	222	166	133	111	
07	1	1,62	278	243	194	162	130	97	78	65
	1,5	1,98	339	297	238	198	158	119	95	79
	2	2,29	393	344	275	229	183	137	110	92
	2,5	2,56	439	384	307	256	205	154	123	102
	3	2,80	480	420	336	280	224	168	134	112
4	3,23	554	485	388	323	258	194	155	129	
10	1	2,3	394	345	276	230	184	138	110	92
	1,5	2,8	480	420	336	280	224	168	134	112
	2	3,3	566	495	396	330	264	198	158	132
	2,5	3,7	634	555	444	370	296	222	178	148
	3	4,0	686	600	480	400	320	240	192	160
4	4,6	789	690	552	460	368	276	221	184	
15	1	3,5	600	525	420	350	280	210	168	140
	1,5	4,2	720	630	504	420	336	252	202	168
	2	4,9	840	735	588	490	392	294	235	196
	2,5	5,5	943	825	660	550	440	330	264	220
	3	6,0	1029	900	720	600	480	360	288	240
4	6,9	1183	1035	828	690	552	414	331	276	
20	1	4,6	789	690	552	460	368	276	221	184
	1,5	5,7	977	855	684	570	456	342	274	228
	2	6,5	1114	975	780	650	520	390	312	260
	2,5	7,3	1251	1095	876	730	584	438	350	292
	3	8,0	1371	1200	960	800	640	480	384	320
4	9,2	1577	1380	1104	920	736	552	442	368	
30	1	6,9	1183	1035	828	690	552	414	331	276
	1,5	8,5	1457	1275	1020	850	680	510	408	340
	2	9,8	1680	1470	1176	980	784	588	470	392
	2,5	11,0	1886	1650	1320	1100	880	660	528	440
	3	12,0	2057	1800	1440	1200	960	720	576	480
4	13,9	2383	2085	1668	1390	1112	834	667	556	

Features	
Common Use	Fertilizer
Pattern	Stream
Technology	Round Orifice
Material	PVDF
Spray Angle	0°
Pressure Range	15-60 PSI (1-4 BAR)
Configuration	1/4" MNPT or BSP
Part Numbers	
NPT	BSP
90A2CM02E00	90B2CM02E00
90A2CM03E00	90B2CM03E00
90A2CM04E00	90B2CM04E00
90A2CM05E00	90B2CM05E00
90A2CM06E00	90B2CM06E00
90A2CM07E00	90B2CM07E00
90A2CM10E00	90B2CM10E00
90A2CM15E00	90B2CM15E00
90A2CM20E00	90B2CM20E00
90A2CM30E00	90B2CM30E00



# Flow Regulating Disc DC



The Hypro Flow Regulating Disc – DC is commonly paired with push-to-connect products in liquid fertilizer systems onboard planting equipment.

- Regulates flow and produces a straight stream pattern
- Precision-molded in polyacetal for reliable performance
- Conveniently packaged in a quantity of ten

## US Units

Disc	US Gallon/Min										
	PSI										
	10	15	20	25	30	35	40	60	80	100	150
30-DC-00	0	0	0	0	0	0	0	0	0	0	0
30-DC010	0.008	0.010	0.011	0.013	0.014	0.015	0.016	0.020	0.023	0.025	0.031
30-DC018	0.030	0.037	0.042	0.047	0.052	0.056	0.060	0.073	0.085	0.095	0.116
30-DC023	0.038	0.047	0.054	0.060	0.066	0.071	0.076	0.093	0.107	0.120	0.147
0-DC-01	0.057	0.070	0.081	0.090	0.099	0.107	0.114	0.140	0.161	0.180	0.221
30-DC-015	0.078	0.096	0.110	0.123	0.135	0.146	0.156	0.191	0.221	0.247	0.302
30-DC-02	0.105	0.129	0.148	0.166	0.182	0.196	0.210	0.257	0.297	0.332	0.407
30-DC-03	0.133	0.163	0.188	0.210	0.230	0.249	0.266	0.326	0.376	0.421	0.515
30-DC-035	0.175	0.214	0.247	0.277	0.303	0.327	0.350	0.429	0.495	0.553	0.678
30-DC-04	0.242	0.296	0.342	0.383	0.419	0.453	0.484	0.593	0.684	0.765	0.937
30-DC-05	0.392	0.480	0.554	0.620	0.679	0.733	0.784	0.960	1.11	1.24	1.52
30-DC-06	0.570	0.698	0.806	0.901	0.987	1.07	1.14	1.40	1.61	1.80	2.21
30-DC-07	0.760	0.931	1.07	1.20	1.32	1.42	1.52	1.86	2.15	2.40	2.94
30-DC-08	0.960	1.18	1.36	1.52	1.66	1.80	1.92	2.35	2.72	3.04	3.72
30-DC-10	1.55	1.90	2.19	2.45	2.68	2.90	3.10	3.80	4.38	4.90	6.00
30-DC-12	2.20	2.69	3.11	3.48	3.81	4.12	4.40	5.39	6.22	6.96	8.52

## Metric Units

Disc	Flow L/min									
	Pressure BAR									
	1	2	3	4	5	6	7	8	9	10
30-DC010	0,037	0,052	0,064	0,074	0,083	0,091	0,098	0,105	0,111	0,117
30-DC018	0,14	0,20	0,24	0,28	0,31	0,34	0,37	0,39	0,42	0,44
30-DC023	0,18	0,25	0,31	0,36	0,40	0,44	0,47	0,51	0,54	0,57
30-DC-01	0,26	0,37	0,45	0,52	0,58	0,64	0,69	0,73	0,78	0,82
30-DC015	0,36	0,51	0,62	0,72	0,80	0,88	0,95	1,01	1,07	1,13
30-DC-02	0,48	0,68	0,83	0,96	1,07	1,17	1,27	1,36	1,44	1,52
30-DC-03	0,61	0,86	1,05	1,21	1,36	1,48	1,60	1,71	1,82	1,92
30-DC-04	1,10	1,56	1,91	2,21	2,47	2,70	2,92	3,12	3,31	3,49
30-DC-05	1,79	2,53	3,10	3,58	4,00	4,38	4,74	5,06	5,37	5,66
30-DC-06	2,61	3,69	4,52	5,22	5,84	6,39	6,90	7,38	7,83	8,25
30-DC-07	3,49	4,94	6,05	6,99	7,81	8,56	9,24	9,88	10,48	11,05
30-DC-08	4,39	6,21	7,60	8,78	9,81	10,75	11,61	12,41	13,16	13,88
30-DC-10	7,35	10,39	12,73	14,70	16,43	18,00	19,45	20,79	22,05	23,24
30-DC-12	9,93	14,04	17,20	19,86	22,21	24,32	26,27	28,09	29,79	31,40

## Features

Common Use	Fertilizer
Pattern	Stream
Technology	Round Orifice
Material	Polyacetal
Spray Angle	0°
Pressure Range	10-150 PSI (1-10 BAR)
Configuration	Disc

## Part Numbers

Nozzles	Nozzles (10 per bag)
30-DC-00	10BG-30-DC-00
30-DC010	10BG-30-DC010
30-DC018	10BG-30-DC018
30-DC023	10BG-30-DC023
30-DC-01	10BG-30-DC-01
30-DC-015	10BG-30-DC-015
30-DC-02	10BG-30-DC-02
30-DC-03	10BG-30-DC-03
30-DC-035	10BG-30-DC-035
30-DC-04	10BG-30-DC-04
30-DC-05	10BG-30-DC-05
30-DC-06	10BG-30-DC-06
30-DC-07	10BG-30-DC-07
30-DC-08	10BG-30-DC-08
30-DC-10	10BG-30-DC-10
30-DC-12	10BG-30-DC-12
<b>Split Gasket (10 per bag)</b>	
10BG-1700-0255	



# Flow Regulating Disc AMT 0°

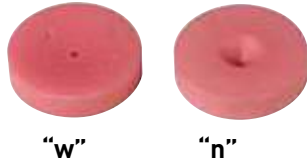

The Albuz® ceramic disc regulates flow and produces a straight stream pattern.

- Precision-molded in ceramic
- Flexibility of flow rate is achieved through changing disc orientation

## US Units

Disc	US Gallon/Min														
	10	15	20	25	30	PSI		40	60	80	100	150	200	300	725
AMT-15007 (n)	0.063	0.077	0.088	0.099	0.108	0.117	0.125	0.153	0.177	0.198	0.242	0.280	0.342	0.532	
AMT-15007 (w)	0.064	0.078	0.091	0.101	0.111	0.120	0.128	0.157	0.181	0.202	0.248	0.286	0.351	0.545	
AMT-15008 (n)	0.066	0.080	0.093	0.104	0.113	0.123	0.131	0.160	0.185	0.207	0.254	0.293	0.359	0.558	
AMT-15008 (w)	0.083	0.101	0.117	0.130	0.143	0.154	0.165	0.202	0.233	0.261	0.320	0.369	0.452	0.702	
AMT-15010 (n)	0.099	0.121	0.140	0.157	0.171	0.185	0.198	0.242	0.280	0.313	0.383	0.443	0.542	0.843	
AMT-15010 (w)	0.139	0.170	0.197	0.220	0.241	0.260	0.278	0.340	0.393	0.440	0.538	0.622	0.761	1.18	
AMT-15012 (n)	0.144	0.176	0.203	0.227	0.249	0.268	0.287	0.352	0.406	0.454	0.556	0.642	0.786	1.22	
AMT-15012 (w)	0.174	0.213	0.246	0.275	0.301	0.326	0.348	0.426	0.492	0.550	0.674	0.778	0.953	1.48	
AMT-15015 (n)	0.217	0.265	0.306	0.342	0.375	0.405	0.433	0.530	0.612	0.685	0.839	0.968	1.19	1.84	
AMT-15015 (w)	0.287	0.351	0.405	0.453	0.496	0.536	0.573	0.702	0.810	0.906	1.11	1.28	1.57	2.44	
AMT-15018 (n)	0.302	0.370	0.427	0.478	0.523	0.565	0.604	0.740	0.854	0.955	1.17	1.35	1.65	2.57	
AMT-15020 (n)	0.375	0.459	0.530	0.593	0.650	0.702	0.750	0.919	1.06	1.19	1.45	1.68	2.05	3.19	
AMT-15018 (w)	0.388	0.475	0.548	0.613	0.671	0.725	0.775	0.949	1.10	1.23	1.50	1.73	2.12	3.30	
AMT-15020 (w)	0.472	0.577	0.667	0.746	0.817	0.882	0.943	1.15	1.33	1.49	1.83	2.11	2.58	4.01	
AMT-15023 (n)	0.485	0.594	0.686	0.767	0.840	0.907	0.970	1.19	1.37	1.53	1.88	2.17	2.66	4.13	
AMT-15023 (w)	0.605	0.741	0.856	0.957	1.05	1.13	1.21	1.48	1.71	1.91	2.34	2.71	3.31	5.15	

Features	
Common Use	Fertilizer
Pattern	Stream
Technology	Round Orifice
Material	Ceramic
Spray Angle	0°
Pressure Range	10-725 PSI (1-50 BAR)
Configuration	Disc

## Part Numbers

### Nozzles

AMT-15007
AMT-15008
AMT-15010
AMT-15012
AMT-15015
AMT-15018
AMT-15020
AMT-15023

w - Numbers can be read on face of disc when installed in cap  
 n - Numbers on disc cannot be read when installed in cap  
 Photos above show the disc exit side.

## Metric Units

Disc	Liters/Min													
	0.7	1.0	1.4	1.7	2.1	2.4	2.8	4.1	5.5	6.9	10.3	13.8	20.7	50.0
AMT-15007 (n)	0.238	0.291	0.333	0.375	0.409	0.443	0.473	0.579	0.670	0.750	0.916	1.060	1.295	2.014
AMT-15007 (w)	0.242	0.295	0.344	0.382	0.420	0.454	0.485	0.594	0.685	0.765	0.939	1.083	1.329	2.063
AMT-15008 (n)	0.250	0.303	0.352	0.394	0.428	0.466	0.496	0.606	0.700	0.784	0.961	1.109	1.359	2.112
AMT-15008 (w)	0.314	0.382	0.443	0.492	0.541	0.583	0.625	0.765	0.882	0.988	1.211	1.397	1.711	2.657
AMT-15010 (n)	0.375	0.458	0.530	0.594	0.647	0.700	0.750	0.916	1.060	1.185	1.450	1.677	2.052	3.191
AMT-15010 (w)	0.526	0.644	0.746	0.833	0.912	0.984	1.052	1.287	1.488	1.666	2.037	2.355	2.881	4.467
AMT-15012 (n)	0.545	0.666	0.768	0.859	0.943	1.014	1.086	1.332	1.537	1.719	2.105	2.430	2.975	4.618
AMT-15012 (w)	0.659	0.806	0.931	1.041	1.139	1.234	1.317	1.613	1.862	2.082	2.551	2.945	3.607	5.602
AMT-15015 (n)	0.821	1.003	1.158	1.295	1.420	1.533	1.639	2.006	2.317	2.593	3.176	3.664	4.505	6.965
AMT-15015 (w)	1.086	1.329	1.533	1.715	1.878	2.029	2.169	2.657	3.066	3.430	4.202	4.845	5.943	9.236
AMT-15018 (n)	1.143	1.401	1.616	1.809	1.980	2.139	2.286	2.801	3.233	3.615	4.429	5.110	6.246	9.729
AMT-15020 (n)	1.420	1.738	2.006	2.245	2.461	2.657	2.839	3.479	4.013	4.505	5.489	6.359	7.760	12.075
AMT-15018 (w)	1.469	1.798	2.074	2.320	2.540	2.744	2.934	3.592	4.164	4.656	5.678	6.549	8.025	12.492
AMT-15020 (w)	1.787	2.184	2.525	2.824	3.093	3.339	3.570	4.353	5.035	5.640	6.927	7.987	9.766	15.180
AMT-15023 (n)	1.836	2.249	2.597	2.903	3.180	3.433	3.672	4.505	5.186	5.792	7.117	8.214	10.069	15.634
AMT-15023 (w)	2.290	2.805	3.240	3.623	3.975	4.278	4.580	5.602	6.473	7.230	8.858	10.258	12.530	19.495

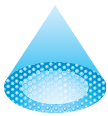

# Hollow Cone - SwirlTip Disc & Cores 25°-110°



Disc



Core

The Hypro SwirlTip disc and core hollow-cone spray nozzles produce finely atomized droplets.

- Hollow cone pattern in a variety of spray pattern widths
- Discs conveniently packaged in a quantity of ten

## US Units

Disc	Core	Spray Angle at 40 PSI	Color Disc/Core	US Gallon/Min							
				10	20	30	40	60	80	100	150
30-DC-01	30-CR-13	50	Gray/Red	-	-	0.06	0.07	0.08	0.09	0.10	0.13
30-DC-015	30-CR-13	55	Black/Red	-	-	0.06	0.07	0.09	0.10	0.11	0.14
30-DC-02	30-CR-13	65	Brown/Red	-	0.06	0.07	0.08	0.10	0.12	0.13	0.16
30-DC-03	30-CR-13	70	Orange/Red	-	0.06	0.08	0.09	0.11	0.12	0.14	0.17
30-DC-04	30-CR-13	80	Red/Red	0.06	0.08	0.10	0.12	0.14	0.17	0.19	0.23
30-DC-01	30-CR-23	45	Gray/LightBlue	-	-	0.06	0.07	0.09	0.10	0.11	0.14
30-DC-015	30-CR-23	50	Black/LightBlue	-	-	0.07	0.09	0.10	0.12	0.13	0.16
30-DC-02	30-CR-23	70	Brown/LightBlue	-	0.08	0.09	0.11	0.13	0.15	0.17	0.21
30-DC-03	30-CR-23	70	Orange/LightBlue	0.06	0.08	0.10	0.12	0.14	0.16	0.18	0.22
30-DC-04	30-CR-23	80	Red/LightBlue	0.08	0.11	0.13	0.15	0.19	0.22	0.24	0.30
30-DC-05	30-CR-23	90	Blue/LightBlue	0.09	0.13	0.16	0.18	0.22	0.25	0.28	0.35
30-DC-06	30-CR-23	90	Yellow/LightBlue	0.10	0.15	0.18	0.21	0.25	0.29	0.33	0.40
30-DC-01	30-CR-25	25	Gray/Yellow	-	-	0.09	0.10	0.12	0.14	0.16	0.19
30-DC-015	30-CR-25	40	Black/Yellow	-	-	0.11	0.13	0.16	0.19	0.21	0.26
30-DC-02	30-CR-25	50	Brown/Yellow	-	0.11	0.13	0.16	0.19	0.22	0.25	0.30
30-DC-03	30-CR-25	60	Orange/Yellow	0.09	0.13	0.16	0.19	0.23	0.27	0.30	0.36
30-DC-04	30-CR-25	75	Red/Yellow	0.14	0.19	0.24	0.28	0.34	0.39	0.43	0.53
30-DC-05	30-CR-25	80	Blue/Yellow	0.18	0.25	0.30	0.35	0.43	0.49	0.55	0.68
30-DC-06	30-CR-25	85	Yellow/Yellow	0.23	0.32	0.39	0.45	0.55	0.64	0.71	0.87
30-DC-07	30-CR-25	90	Green/Yellow	0.25	0.35	0.43	0.50	0.61	0.71	0.79	0.97
30-DC-08	30-CR-25	95	White/Yellow	0.30	0.42	0.52	0.60	0.73	0.85	0.95	1.16
30-DC-10	30-CR-25	100	LimeGreen/Yellow	0.38	0.53	0.65	0.75	0.92	1.06	1.19	1.45
30-DC-12	30-CR-25	110	RoyalBlue/Yellow	0.46	0.65	0.80	0.93	1.13	1.31	1.46	1.79
30-DC-01	30-CR-45	25	Gray/Green	-	-	-	0.12	0.15	0.17	0.19	0.23
30-DC-015	30-CR-45	35	Black/Green	-	-	0.14	0.16	0.20	0.23	0.25	0.31
30-DC-02	30-CR-45	45	Brown/Green	-	0.14	0.17	0.20	0.24	0.28	0.32	0.39
30-DC-03	30-CR-45	55	Orange/Green	-	0.16	0.20	0.23	0.28	0.32	0.36	0.44
30-DC-04	30-CR-45	70	Red/Green	0.18	0.25	0.30	0.35	0.43	0.49	0.55	0.68
30-DC-05	30-CR-45	75	Blue/Green	0.23	0.32	0.39	0.45	0.55	0.64	0.71	0.87
30-DC-06	30-CR-45	80	Yellow/Green	0.29	0.41	0.50	0.58	0.70	0.81	0.91	1.11
30-DC-07	30-CR-45	85	Green/Green	0.34	0.48	0.58	0.68	0.83	0.95	1.07	1.31
30-DC-08	30-CR-45	90	White/Green	0.41	0.58	0.71	0.83	1.01	1.17	1.30	1.60
30-DC-10	30-CR-45	95	LimeGreen/Green	0.55	0.78	0.95	1.10	1.35	1.56	1.74	2.13
30-DC-12	30-CR-45	100	RoyalBlue/Green	0.67	0.95	1.16	1.34	1.64	1.90	2.12	2.60

## DC/CR Disc Core

	40 PSI	50 PSI	60 PSI	70 PSI	80 PSI	90 PSI	100 PSI	125 PSI	150 PSI
30-DC-01/30-CR-23	F	F	VF	VF	VF	VF	VF	VF	VF
30-DC-015/30-CR-23	F	F	VF	VF	VF	VF	VF	VF	VF
30-DC-02/30-CR-23	F	F	F	VF	VF	VF	VF	VF	VF
30-DC-03/30-CR-23	F	F	F	F	VF	VF	VF	VF	VF
30-DC-04/30-CR-23	F	F	F	F	F	F	VF	VF	VF
30-DC-05/30-CR-23	F	F	F	F	F	F	F	VF	VF
30-DC-06/30-CR-23	M	F	F	F	F	F	F	F	VF
30-DC-01/30-CR-25	F	F	F	VF	VF	VF	VF	VF	VF
30-DC-015/30-CR-25	F	F	F	F	VF	VF	VF	VF	VF
30-DC-02/30-CR-25	F	F	F	F	VF	VF	VF	VF	VF
30-DC-03/30-CR-25	F	F	F	F	F	VF	VF	VF	VF
30-DC-04/30-CR-25	M	F	F	F	F	F	F	VF	VF
30-DC-05/30-CR-25	M	M	M	F	F	F	F	VF	VF
30-DC-06/30-CR-25	M	M	M	M	M	M	F	F	F
30-DC-07/30-CR-25	M	M	M	M	M	M	M	F	F
30-DC-08/30-CR-25	C	C	C	C	M	M	M	M	M
30-DC-10/30-CR-25	C	C	C	C	C	M	M	M	M
30-DC-01/30-CR-45	F	F	F	VF	VF	VF	VF	VF	VF
30-DC-015/30-CR-45	M	F	F	F	VF	VF	VF	VF	VF
30-DC-02/30-CR-45	M	M	F	F	F	VF	VF	VF	VF
30-DC-03/30-CR-45	M	M	M	F	F	F	VF	VF	VF
30-DC-04/30-CR-45	M	M	M	M	F	F	F	VF	VF
30-DC-05/30-CR-45	M	M	M	M	M	F	F	F	VF
30-DC-06/30-CR-45	C	M	M	M	M	M	M	F	F
30-DC-07/30-CR-45	C	C	M	M	M	M	M	M	F
30-DC-081/30-CR-45	C	C	C	M	M	M	M	M	M

Droplet size based on ASABE S572.1 standard.



Metric Units

Disc	Core	Spray Angle at 2,75 BAR	Color Disc/Core	Flow L/min							
				Pressure BAR							
				1	2	3	4	5	6	8	10
30-DC-01	30-CR-13	50	Gray/Red	0,16	0,22	0,27	0,31	0,35	0,38	0,44	0,49
30-DC-015	30-CR-13	55	Black/Red	0,17	0,24	0,29	0,33	0,37	0,41	0,47	0,53
30-DC-02	30-CR-13	65	Brown/Red	0,18	0,26	0,32	0,37	0,41	0,45	0,52	0,58
30-DC-03	30-CR-13	70	Orange/Red	0,21	0,29	0,36	0,42	0,46	0,51	0,59	0,66
30-DC-04	30-CR-13	80	Red/Red	0,27	0,38	0,47	0,54	0,61	0,66	0,77	0,86
30-DC-01	30-CR-23	45	Gray/LightBlue	0,16	0,23	0,28	0,32	0,36	0,40	0,46	0,51
30-DC-015	30-CR-23	50	Black/LightBlue	0,21	0,29	0,36	0,42	0,46	0,51	0,59	0,66
30-DC-02	30-CR-23	70	Brown/LightBlue	0,23	0,32	0,39	0,45	0,50	0,55	0,64	0,71
30-DC-03	30-CR-23	70	Orange/LightBlue	0,27	0,38	0,47	0,54	0,61	0,66	0,77	0,86
30-DC-04	30-CR-23	80	Red/LightBlue	0,34	0,48	0,59	0,68	0,76	0,83	0,96	1,08
30-DC-05	30-CR-23	90	Blue/LightBlue	0,41	0,58	0,71	0,82	0,92	1,00	1,16	1,30
30-DC-06	30-CR-23	90	Yellow/LightBlue	0,48	0,68	0,83	0,96	1,07	1,17	1,36	1,52
30-DC-01	30-CR-25	25	Gray/Yellow	0,23	0,33	0,40	0,46	0,52	0,57	0,65	0,73
30-DC-015	30-CR-25	40	Black/Yellow	0,30	0,42	0,52	0,60	0,67	0,74	0,85	0,95
30-DC-02	30-CR-25	50	Brown/Yellow	0,36	0,51	0,63	0,73	0,81	0,89	1,03	1,15
30-DC-03	30-CR-25	60	Orange/Yellow	0,43	0,61	0,75	0,87	0,97	1,06	1,22	1,37
30-DC-04	30-CR-25	75	Red/Yellow	0,66	0,93	1,14	1,32	1,47	1,61	1,86	2,08
30-DC-05	30-CR-25	80	Blue/Yellow	0,80	1,13	1,38	1,59	1,78	1,95	2,25	2,52
30-DC-06	30-CR-25	85	Yellow/Yellow	1,00	1,42	1,74	2,01	2,25	2,46	2,84	3,18
30-DC-07	30-CR-25	90	Green/Yellow	1,18	1,67	2,05	2,37	2,65	2,90	3,35	3,74
30-DC-08	30-CR-25	95	White/Yellow	1,39	1,97	2,41	2,78	3,11	3,41	3,94	4,40
30-DC-10	30-CR-25	100	LimeGreen/Yellow	1,73	2,45	3,00	3,46	3,87	4,24	4,90	5,48
30-DC-12	30-CR-25	110	RoyalBlue/Yellow	2,12	3,00	3,67	4,24	4,74	5,19	5,99	6,70
30-DC-01	30-CR-45	25	Gray/Green	0,28	0,39	0,48	0,55	0,62	0,68	0,78	0,88
30-DC-015	30-CR-45	35	Black/Green	0,37	0,52	0,64	0,74	0,83	0,91	1,05	1,17
30-DC-02	30-CR-45	45	Brown/Green	0,46	0,65	0,80	0,92	1,03	1,13	1,31	1,46
30-DC-03	30-CR-45	55	Orange/Green	0,53	0,74	0,91	1,05	1,17	1,29	1,49	1,66
30-DC-04	30-CR-45	70	Red/Green	0,82	1,16	1,42	1,64	1,83	2,01	2,32	2,59
30-DC-05	30-CR-45	75	Blue/Green	1,03	1,45	1,78	2,06	2,30	2,52	2,91	3,25
30-DC-06	30-CR-45	80	Yellow/Green	1,32	1,87	2,29	2,64	2,96	3,24	3,74	4,18
30-DC-07	30-CR-45	85	Green/Green	1,55	2,19	2,68	3,09	3,46	3,79	4,38	4,89
30-DC-08	30-CR-45	90	White/Green	1,92	2,71	3,32	3,83	4,29	4,70	5,42	6,06
30-DC-10	30-CR-45	95	LimeGreen/Green	2,54	3,59	4,40	5,08	5,68	6,22	7,19	8,03
30-DC-12	30-CR-45	100	RoyalBlue/Green	3,10	4,38	5,37	6,20	6,93	7,59	8,77	9,80

Features		
Common Use	Plant Health	
Pattern	Hollow Cone	
Technology	Swirl	
Material	Polyacetal	
Spray Angle	25° - 110°	
Pressure Range	10-150 PSI (1-10 BAR)	
Configuration	Nozzle	
Part Numbers		
Discs	Discs (10 per Bag)	Cores
30-DC-01	10BG-30-DC-01	30-CR-13
30-DC-015	10BG-30-DC-015	30-CR-23
30-DC-02	10BG-30-DC-02	30-CR-25
30-DC-03	10BG-30-DC-03	30-CR-45
30-DC-04	10BG-30-DC-04	-
30-DC-05	10BG-30-DC-05	-
30-DC-06	10BG-30-DC-06	-
30-DC-07	10BG-30-DC-07	-
30-DC-08	10BG-30-DC-08	-
30-DC-10	10BG-30-DC-10	-
30-DC-12	10BG-30-DC-12	-

DC/CR Disc Core

	2.5 BAR	3 BAR	3.5 BAR	4 BAR	4.5 BAR	5 BAR	5.5 BAR	6 BAR
30-DC-01/30-CR-23	F	F	F	VF	VF	VF	VF	VF
30-DC-02/30-CR-23	F	F	F	F	VF	VF	VF	VF
30-DC-03/30-CR-23	F	F	F	F	F	F	VF	VF
30-DC-04/30-CR-23	F	F	F	F	F	F	F	F
30-DC-05/30-CR-23	M	F	F	F	F	F	F	F
30-DC-06/30-CR-23	M	M	F	F	F	F	F	F
30-DC-01/30-CR-25	F	F	F	F	VF	VF	VF	VF
30-DC-015/30-CR-25	F	F	F	F	F	VF	VF	VF
30-DC-02/30-CR-25	F	F	F	F	F	F	VF	VF
30-DC-03/30-CR-25	M	F	F	F	F	F	F	VF
30-DC-04/30-CR-25	M	M	F	F	F	F	F	F
30-DC-05/30-CR-25	M	M	M	M	M	M	F	F
30-DC-06/30-CR-25	M	M	M	M	M	M	M	M
30-DC-07/30-CR-25	M	M	M	M	M	M	M	M
30-DC-08/30-CR-25	C	C	C	C	C	C	M	M
30-DC-10/30-CR-25	C	C	C	C	C	C	M	M
30-DC-01/30-CR-45	M	F	F	F	F	VF	VF	VF
30-DC-015/30-CR-45	M	M	F	F	F	F	VF	VF
30-DC-02/30-CR-45	M	M	M	F	F	F	F	VF
30-DC-03/30-CR-45	M	M	M	M	F	F	F	F
30-DC-04/30-CR-45	M	M	M	M	M	M	M	F
30-DC-05/30-CR-45	M	M	M	M	M	M	M	M
30-DC-06/30-CR-45	C	M	M	M	M	M	M	F
30-DC-07/30-CR-45	C	C	C	M	M	M	M	M
30-DC-08/30-CR-45	C	C	C	C	M	M	M	M

Droplet size based on ASABE S572.1 standard.



# Hollow Cone - Ceramic Disc & Cores 13° - 93°



Albuz® ceramic discs and cores are the longest lasting disc-core nozzles, making them ideal for abrasive agricultural and horticultural sprays. DCC/CRC nozzles will outlast stainless steel disc-core nozzles by up to 10 times and perform superbly at high pressures, common on many air-blast and directed sprayers.

## US Units

DISC	Hollow Cone CORE	Flow Rate GPM at Pressure, PSI										Spray Angle Degrees		
		10	20	30	40	60	80	100	150	200	300	20	40	80
DCC-01	CRC-13	-	-	0.059	0.066	0.078	0.088	0.097	0.115	0.128	0.152	-	51	62
DCC-02	CRC-13	-	0.064	0.075	0.08	0.10	0.11	0.12	0.14	0.16	0.18	49	67	72
DCC-03	CRC-13	-	0.071	0.08	0.09	0.11	0.12	0.13	0.16	0.18	0.20	53	70	75
DCC-04	CRC-13	0.07	0.09	0.11	0.12	0.14	0.16	0.17	0.20	0.23	0.27	69	79	83
DCC-01	CRC-23	-	-	0.064	0.072	0.080	0.096	0.107	0.124	0.139	0.164	-	47	58
DCC-02	CRC-23	-	0.078	0.092	0.10	0.13	0.14	0.16	0.19	0.21	0.25	51	63	70
DCC-03	CRC-23	0.065	0.087	0.10	0.12	0.14	0.16	0.18	0.21	0.24	0.28	58	69	75
DCC-04	CRC-23	0.082	0.113	0.14	0.15	0.19	0.21	0.23	0.28	0.32	0.38	68	82	87
DCC-05	CRC-23	0.095	0.13	0.16	0.18	0.22	0.25	0.28	0.34	0.38	0.46	79	89	94
DCC-06	CRC-23	0.112	0.15	0.19	0.21	0.26	0.29	0.32	0.39	0.45	0.54	84	93	98
DCC-01	CRC-25	-	-	0.088	0.101	0.122	0.138	0.156	0.185	0.210	0.255	-	27	43
DCC-02	CRC-25	-	0.12	0.14	0.16	0.19	0.22	0.25	0.29	0.34	0.41	39	51	58
DCC-03	CRC-25	0.10	0.14	0.17	0.19	0.23	0.26	0.29	0.35	0.40	0.48	52	61	67
DCC-04	CRC-25	0.15	0.21	0.25	0.29	0.35	0.40	0.45	0.54	0.62	0.75	67	74	80
DCC-05	CRC-25	0.18	0.25	0.30	0.35	0.42	0.48	0.54	0.65	0.75	0.90	73	79	84
DCC-06	CRC-25	0.23	0.32	0.39	0.44	0.54	0.62	0.70	0.85	0.97	1.19	79	85	89
DCC-07	CRC-25	0.26	0.37	0.45	0.52	0.63	0.73	0.81	0.98	1.18	1.37	85	91	93
DCC-01	CRC-45	-	-	-	0.125	0.148	0.170	0.190	0.225	0.257	0.310	-	22	34
DCC-02	CRC-45	-	0.14	0.18	0.20	0.25	0.28	0.32	0.38	0.44	0.53	32	46	55
DCC-03	CRC-45	-	0.17	0.20	0.23	0.28	0.33	0.36	0.44	0.51	0.62	40	53	60
DCC-04	CRC-45	0.18	0.25	0.31	0.36	0.43	0.50	0.56	0.68	0.78	0.95	62	69	72
DCC-05	CRC-45	0.23	0.32	0.39	0.45	0.55	0.64	0.71	0.86	0.99	1.22	67	73	76
DCC-06	CRC-45	0.29	0.41	0.50	0.58	0.72	0.83	0.93	1.15	1.33	1.64	73	79	81
DCC-07	CRC-45	0.33	0.48	0.59	0.68	0.84	0.97	1.11	1.34	1.57	1.94	81	86	87
DCC-01	CRC-46	-	-	-	0.145	0.178	0.205	0.23	0.28	0.32	0.39	-	13	15
DCC-02	CRC-46	-	-	0.24	0.27	0.33	0.37	0.42	0.50	0.57	0.68	-	18	21
DCC-03	CRC-46	-	0.23	0.28	0.32	0.39	0.45	0.51	0.61	0.70	0.86	14	20	24
DCC-04	CRC-46	0.28	0.39	0.48	0.56	0.68	0.78	0.88	1.07	1.23	1.52	23	29	33
DCC-05	CRC-46	0.38	0.54	0.66	0.77	0.94	1.10	1.25	1.50	1.73	2.13	33	39	42
DCC-06	CRC-46	0.55	0.78	0.95	1.10	1.35	1.58	1.73	2.16	2.50	3.06	42	48	50
DCC-07	CRC-46	-	0.98	1.22	1.39	1.72	1.97	2.22	2.73	3.15	3.85	48	53	56





**Metric Units**

DISC	Hollow Cone CORE	Flow Rate, LPM							Spray Angle Degrees	
		at Pressure BAR							Pressure, BAR	
		3	4	5	6	10	15	20	10	20
DCC-01	CRC-13	0.280	0.290	0.320	0.340	0.430	0.510	0.570	66	68
DCC-02	CRC-13	0.320	0.370	0.400	0.42	0.52	0.63	0.67	74	75
DCC-03	CRC-13	0.360	0.410	0.43	0.48	0.60	0.71	0.74	77	78
DCC-04	CRC-13	0.47	0.52	0.58	0.60	0.74	0.91	1.00	84	85
DCC-01	CRC-23	0.280	0.300	0.350	0.380	0.480	0.550	0.610	63	65
DCC-02	CRC-23	0.390	0.480	0.500	0.56	0.71	0.83	0.93	72	72
DCC-03	CRC-23	0.470	0.520	0.58	0.64	0.78	0.95	1.04	77	77
DCC-04	CRC-23	0.590	0.710	0.76	0.81	1.04	1.26	1.41	88	87
DCC-05	CRC-23	0.710	0.82	0.90	0.99	1.27	1.50	1.71	96	95
DCC-06	CRC-23	0.830	0.97	1.04	1.13	1.45	1.78	2.01	100	99
DCC-01	CRC-25	0.400	0.420	0.500	0.550	0.690	0.830	0.950	49	51
DCC-02	CRC-25	0.63	0.71	0.79	0.88	1.08	1.34	1.53	61	61
DCC-03	CRC-25	0.75	0.86	0.94	1.02	1.30	1.58	1.79	69	69
DCC-04	CRC-25	1.14	1.30	1.44	1.59	2.01	2.45	2.79	82	82
DCC-05	CRC-25	1.36	1.56	1.73	1.91	2.42	2.96	3.35	85	84
DCC-06	CRC-25	1.74	2.01	2.23	2.47	3.16	3.83	4.43	89	88
DCC-07	CRC-25	2.05	2.34	2.63	2.86	3.85	4.66	5.10	92	91
DCC-01	CRC-45	0.490	0.550	0.610	0.670	0.840	1.010	1.150	39	40
DCC-02	CRC-45	0.79	0.93	1.01	1.13	1.41	1.74	1.97	58	58
DCC-03	CRC-45	0.91	1.04	1.19	1.27	1.84	2.01	2.31	62	62
DCC-04	CRC-45	1.42	1.60	1.80	1.98	2.53	3.08	3.54	73	72
DCC-05	CRC-45	1.78	2.05	2.31	2.51	3.20	3.91	4.54	76	75
DCC-06	CRC-45	2.29	2.68	2.99	3.28	4.28	5.25	6.10	80	79
DCC-07	CRC-45	2.68	3.13	3.50	3.92	5.02	6.20	7.22	86	85
DCC-01	CRC-46	0.570	0.660	0.740	0.810	1.040	1.260	1.45	17	17
DCC-02	CRC-46	1.07	1.23	1.33	1.48	1.86	2.25	2.53	20	18
DCC-03	CRC-46	1.26	1.45	1.62	1.80	2.27	2.76	3.20	23	21
DCC-04	CRC-46	2.21	2.53	2.81	3.11	3.98	4.85	5.86	32	31
DCC-05	CRC-46	3.04	3.50	3.96	4.41	5.58	6.83	7.93	41	40
DCC-06	CRC-46	4.34	5.02	5.69	6.11	8.04	9.87	11.39	49	47
DCC-07	CRC-46	5.49	6.40	7.10	7.84	10.16	12.43	14.33	55	53

Features		
Common Use	Plant Heath	
Pattern	Hollow Cone	
Technology	Swirl	
Material	Ceramic	
Spray Angle	13°-93°	
Pressure Range	10-300 PSI (1-20 BAR)	
Configuration	Nozzle	
Part Numbers		
Discs	Cores	Caps (25 Pack)
DCC-01	CRC-13	CAP05-20
DCC-02	CRC-23	CAP05-20
DCC-03	CRC-45	CAP05-20
DCC-04	CRC-46	CAP05-20
DCC-05	-	CAP05-20
DCC-06	-	CAP05-20
DCC-07	-	CAP05-20

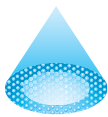

# Hollow Cone - HCX 80°



The Hypro Hollow-Cone spray nozzles are excellent for fungicide and insecticide application. The HCX produces finely atomized droplets in a hollow-cone, 80-degree pattern.

- Precision-molded in polyacetal for durable product life
- Wide operating pressure

## US Units

Spray Nozzle	Flow Rate, GPM at Pressure, PSI											
	40	50	60	70	80	90	100	110	120	130	140	150
30HCX2	0.030	0.034	0.037	0.040	0.042	0.045	0.047	0.050	0.052	0.054	0.056	0.058
30HCX3	0.050	0.056	0.061	0.066	0.071	0.075	0.079	0.083	0.087	0.090	0.094	0.097
30HCX4	0.070	0.078	0.086	0.093	0.099	0.105	0.111	0.116	0.121	0.126	0.131	0.136
30HCX6	0.102	0.114	0.125	0.135	0.144	0.153	0.161	0.169	0.177	0.184	0.191	0.198
30HCX8	0.133	0.149	0.163	0.176	0.188	0.200	0.210	0.221	0.230	0.240	0.249	0.258
30HCX9	0.148	0.165	0.181	0.196	0.209	0.222	0.234	0.245	0.256	0.267	0.277	0.287
30HCX10	0.164	0.183	0.201	0.217	0.232	0.246	0.259	0.272	0.284	0.296	0.307	0.318
30HCX12	0.203	0.227	0.249	0.269	0.287	0.305	0.321	0.337	0.352	0.366	0.380	0.393
30HCX18	0.300	0.335	0.367	0.397	0.424	0.450	0.474	0.497	0.520	0.541	0.561	0.581

Features	
Common Use	Plant Health
Pattern	Hollow Cone
Technology	Swirl
Material	Polyacetal
Spray Angle	80°
Pressure Range	40-150 PSI [3-10 BAR]
Configuration	Nozzle
Part Numbers	
Nozzles 80°	Caps (25 Pack)
30HCX2	CAP04-20
30HCX3	CAP04-20
30HCX4	CAP04-20
30HCX6	CAP04-20
30HCX8	CAP04-20
30HCX9	CAP04-20
30HCX10	CAP04-20
30HCX12	CAP04-20
30HCX18	CAP04-20

## HCX80° - Hollow Cone

	40 PSI	50 PSI	60 PSI	70 PSI	80 PSI	90 PSI	100 PSI	125 PSI	150 PSI
30HCX2	F	F	F	F	VF	VF	VF	VF	VF
30HCX3	F	F	F	F	F	F	F	VF	VF
30HCX4	F	F	F	F	F	F	F	F	VF
30HCX6	M	F	F	F	F	F	F	F	F
30HCX8	F	VF	VF	VF	VF	VF	VF	VF	VF
30HCX9	F	F	F	VF	VF	VF	VF	VF	VF
30HCX10	F	F	VF	VF	VF	VF	VF	VF	VF
30HCX12	F	F	F	VF	VF	VF	VF	VF	VF
30HCX18	F	F	F	F	F	F	F	VF	VF

Droplet size based on ASABE S572.1 standard.

## Metric Units

Spray Nozzle	Flow L/min at Pressure, BAR											
	3	3,5	4	4,5	5	5,5	6	6,5	7	8	9	10
30HCX2	0,132	0,143	0,152	0,162	0,170	0,179	0,187	0,194	0,202	0,216	0,229	0,241
30HCX3	0,199	0,215	0,230	0,244	0,257	0,269	0,281	0,293	0,304	0,325	0,345	0,363
30HCX4	0,265	0,286	0,306	0,325	0,342	0,359	0,375	0,390	0,405	0,433	0,459	0,484
30HCX6	0,397	0,429	0,458	0,486	0,513	0,538	0,561	0,584	0,606	0,648	0,688	0,725
30HCX8	0,530	0,572	0,612	0,649	0,684	0,718	0,750	0,780	0,810	0,865	0,918	0,968
30HCX9	0,596	0,644	0,688	0,730	0,769	0,807	0,843	0,877	0,910	0,973	1,032	1,088
30HCX10	0,662	0,715	0,764	0,811	0,855	0,896	0,936	0,974	1,011	1,081	1,147	1,209
30HCX12	0,750	0,810	0,866	0,919	0,968	1,016	1,061	1,104	1,146	1,225	1,299	1,369
30HCX18	1,180	1,275	1,363	1,445	1,523	1,598	1,669	1,737	1,802	1,927	2,044	2,154

## HCX80° - Hollow Cone

	3 BAR	4 BAR	5 BAR	6 BAR	7 BAR	8 BAR	9 BAR	10 BAR	11 BAR
30HCX2	F	F	F	VF	VF	VF	VF	VF	VF
30HCX3	F	F	F	F	F	VF	VF	VF	VF
30HCX4	F	F	F	F	F	F	VF	VF	VF
30HCX6	M	F	F	F	F	F	F	F	F
30HCX8	F	F	VF	VF	VF	VF	VF	VF	VF
30HCX9	F	F	VF	VF	VF	VF	VF	VF	VF
30HCX10	F	VF	VF	VF	VF	VF	VF	VF	VF
30HCX12	F	F	VF	VF	VF	VF	VF	VF	VF
30HCX18	F	F	F	F	F	VF	VF	VF	VF

Droplet size based on ASABE S572.1 standard.



# Hollow Cone - Ceramic ATR 80°



The Albu<sup>z</sup>® hollow-cone ceramic spray nozzles produce finely atomized droplets in a hollow-cone, 80-degree pattern.

- Easily separated, two-piece construction for simple cleaning
- Wide operating pressure range suitable for many applications
- Commonly used in airblast and other high pressure spraying applications

## US Units

Spray Nozzle	Flow Rate, GPM at Pressure, PSI												
	40	50	60	70	80	90	100	120	150	200	250	300	350
ATR-WHITE	0.053	0.060	0.065	0.070	0.075	0.079	0.083	0.091	0.101	0.116	0.129	0.141	0.152
ATR-LILAC	0.071	0.079	0.087	0.093	0.099	0.105	0.111	0.121	0.134	0.154	0.171	0.187	0.201
ATR-BROWN	0.095	0.106	0.116	0.125	0.133	0.141	0.148	0.161	0.180	0.206	0.230	0.250	0.270
ATR-YELLOW	0.144	0.161	0.176	0.189	0.202	0.214	0.226	0.247	0.275	0.317	0.354	0.387	0.417
ATR-ORANGE	0.196	0.218	0.239	0.257	0.274	0.290	0.306	0.334	0.372	0.428	0.477	0.521	0.561
ATR-RED	0.275	0.306	0.333	0.359	0.382	0.404	0.425	0.463	0.515	0.591	0.657	0.716	0.771
ATR-GRAY	0.299	0.333	0.362	0.390	0.415	0.439	0.461	0.502	0.558	0.638	0.709	0.773	0.831
ATR-GREEN	0.356	0.395	0.430	0.463	0.493	0.521	0.547	0.596	0.662	0.758	0.842	0.918	0.987
ATR-BLACK	0.399	0.443	0.483	0.520	0.554	0.585	0.615	0.671	0.745	0.854	0.949	1.034	1.113
ATR-BLUE	0.488	0.542	0.591	0.636	0.678	0.716	0.753	0.821	0.913	1.046	1.163	1.268	1.364

Features	
Common Use	Plant Health
Pattern	Hollow Cone
Technology	Swirl
Material	Ceramic
Spray Angle	80°
Pressure Range	40-350 PSI (3-24 BAR)
Configuration	Nozzle

Part Numbers	
ATR 80°	Caps (25 Pack)
ATR-WHITE	CAP05-20
ATR-LILAC	CAP05-20
ATR-BROWN	CAP05-20
ATR-YELLOW	CAP05-20
ATR-ORANGE	CAP05-20
ATR-RED	CAP05-20
ATR-GRAY	CAP05-20
ATR-GREEN	CAP05-20
ATR-BLACK	CAP05-20
ATR-BLUE	CAP05-20

## ATR 80° - Hollow Cone

	40 PSI	50 PSI	60 PSI	70 PSI	80 PSI	90 PSI	100 PSI	125 PSI	150 PSI	350 PSI
ATR- White	VF	VF	VF	VF	VF	VF	VF	VF	VF	VF
ATR- Lilac	VF	VF	VF	VF	VF	VF	VF	VF	VF	VF
ATR- Brown	VF	VF	VF	VF	VF	VF	VF	VF	VF	VF
ATR- Yellow	F	VF	VF	VF	VF	VF	VF	VF	VF	VF
ATR- Orange	F	F	VF	VF	VF	VF	VF	VF	VF	VF
ATR- Red	F	F	F	VF	VF	VF	VF	VF	VF	VF
ATR- Gray	F	F	F	F	F	VF	VF	VF	VF	VF
ATR- Green	F	F	F	F	F	VF	VF	VF	VF	VF
ATR- Black	F	F	F	F	F	F	F	VF	VF	VF
ATR- Blue	M	M	M	M	F	F	F	F	F	F

Droplet size based on ASABE S572.1 standard.

## Metric Units

Spray Nozzle	Flow Rate, LPM at Pressure, Bar																								
	5	6	7	8	9	10	11	12	13	14	15	16	17	18	19	20	21	22	23	24	25				
ATR-WHITE	0.27	0.29	0.32	0.34	0.36	0.38	0.39	0.41	0.43	0.44	0.46	0.47	0.48	0.50	0.51	0.52	0.54	0.55	0.56	0.57	0.58				
ATR-LILAC	0.36	0.39	0.42	0.45	0.48	0.50	0.52	0.55	0.57	0.59	0.61	0.63	0.64	0.66	0.68	0.70	0.71	0.73	0.74	0.76	0.77				
ATR-BROWN	0.48	0.52	0.56	0.60	0.64	0.67	0.70	0.73	0.76	0.79	0.81	0.84	0.86	0.89	0.91	0.93	0.95	0.98	1.00	1.02	1.04				
ATR-YELLOW	0.73	0.80	0.86	0.92	0.97	1.03	1.07	1.12	1.17	1.21	1.25	1.29	1.33	1.37	1.40	1.44	1.48	1.51	1.54	1.58	1.61				
ATR-ORANGE	0.99	1.08	1.17	1.24	1.32	1.39	1.45	1.51	2.57	1.63	1.69	1.74	1.79	1.84	1.89	1.94	1.99	2.03	2.07	2.12	2.16				
ATR-RED	1.38	1.51	1.62	1.73	1.83	1.92	2.01	2.09	2.17	2.25	2.33	2.40	2.47	2.54	2.60	2.67	2.73	2.79	2.85	2.91	2.97				
ATR-GRAY	1.50	1.63	1.76	1.87	1.98	2.08	2.17	2.26	2.35	2.43	2.51	2.59	2.67	2.74	2.81	2.88	2.95	3.01	3.07	3.14	3.20				
ATR-GREEN	1.78	1.94	2.09	2.22	2.35	2.47	2.58	2.69	2.79	2.89	2.99	3.08	3.17	3.25	3.34	3.42	3.50	3.57	3.65	3.72	3.80				
ATR-BLACK	2.00	2.18	2.35	2.50	2.64	2.80	2.90	3.03	3.14	3.26	3.36	3.47	3.57	3.67	3.76	3.85	3.94	4.03	4.12	4.20	4.28				
ATR-BLUE	2.45	2.67	1.87	3.06	3.24	3.40	3.56	3.71	3.85	3.99	4.12	4.25	4.37	4.49	4.61	4.72	4.84	4.94	5.05	5.15	5.25				

## ATR 80° - Hollow Cone

	3 Bar	5 Bar	7 Bar	10 Bar	15 Bar	20 Bar
ATR- White	VF	VF	VF	VF	VF	VF
ATR- Lilac	VF	VF	VF	VF	VF	VF
ATR- Brown	VF	VF	VF	VF	VF	VF
ATR- Yellow	F	VF	VF	VF	VF	VF
ATR- Orange	F	VF	VF	VF	VF	VF
ATR- Red	F	F	VF	VF	VF	VF
ATR- Gray	F	F	F	VF	VF	VF
ATR- Green	F	F	F	VF	VF	VF
ATR- Black	F	F	F	F	VF	VF
ATR- Blue	M	M	F	F	F	F

Droplet size based on ASABE S572.1 standard.

Albu<sup>z</sup>® is a registered trademark of SAINT-GOBAIN SOLCERA, SAINT GOBAIN CERAMIQUES AVANCEES DESMARQUEST, CERAMIQUES TECHNIQUES DESMARQUEST, and SOCIETE DESMARQUEST ET CEC  
Hypro® is a registered trademark of Pentair.



# Hollow Cone - Ceramic TVI 80°



The Albu<sup>z</sup>® TVI drastically reduces the potential for spray drift in broadcast, directed, and air-blast applications. The air-induced hollow-cone pattern stays on target, saving chemical and reducing environmental impact.

- All ceramic orifice creates extremely long life
- Air-filled droplets control drift and reduce chemical waste

## US Units

Spray Nozzle	Flow Rate, GPM at Pressure, PSI															
	70	80	100	120	140	160	180	200	220	240	260	280	300	320	340	360
TVI-80005	0.066	0.071	0.079	0.087	0.094	0.100	0.106	0.112	0.117	0.122	0.127	0.132	0.137	0.141	0.146	0.150
TVI-800075	0.099	0.106	0.119	0.130	0.140	0.150	0.159	0.168	0.176	0.184	0.191	0.198	0.205	0.212	0.219	0.225
TVI-80015	0.198	0.212	0.237	0.260	0.281	0.300	0.318	0.335	0.352	0.367	0.382	0.397	0.411	0.424	0.437	0.450
TVI-8002	0.265	0.283	0.316	0.346	0.374	0.400	0.424	0.447	0.469	0.490	0.510	0.529	0.548	0.566	0.583	0.600
TVI-80025	0.331	0.354	0.395	0.433	0.468	0.500	0.530	0.559	0.586	0.612	0.637	0.661	0.685	0.707	0.729	0.750
TVI-8003	0.397	0.424	0.474	0.520	0.561	0.600	0.636	0.671	0.704	0.735	0.765	0.794	0.822	0.849	0.875	0.900

## TVI 80° - Hollow Cone

	70 PSI	150 PSI	200 PSI
TVI-80005	XC	C	C
TVI-800075	XC	C	C
TVI-80015	XC	C	C
TVI-8002	XC	XC	VC
TVI-80025	XC	XC	VC

Droplet size based on ASABE S572.1 standard.

## Metric Units

Spray Nozzle	Flow Rate, LPM at Pressure, Bar																				
	5	6	7	8	9	10	11	12	13	14	15	16	17	18	19	20	21	22	23	24	25
TVI-80005			0.31	0.33	0.35	0.37	0.38	0.40	0.42	0.43	0.45	0.46	0.48	0.49	0.50	0.52	0.53	0.54	0.55	0.57	0.58
TVI-800075	0.39	0.42	0.46	0.49	0.52	0.55	0.57	0.60	0.62	0.65	0.67	0.69	0.71	0.73	0.75	1.03	0.79	0.81	0.83	0.85	0.87
TVI-80015	0.77	0.85	0.92	0.98	1.04	1.10	1.15	1.20	1.25	1.30	1.34	1.39	1.43	1.47	1.51	1.55	1.59	1.62	1.66	1.70	1.73
TVI-8002	1.03	1.13	1.22	1.31	1.39	1.46	1.53	1.60	1.67	1.73	1.79	1.85	1.90	1.96	2.01	2.07	2.12	2.17	2.22	2.26	2.31
TVI-80025	1.03	1.41	1.53	1.63	1.73	1.83	1.91	2.00	2.08	2.16	2.24	2.31	2.38	2.45	2.52	2.58	2.65	2.71	2.77	2.83	2.89
TVI-8003	1.55	1.70	1.83	1.96	2.03	2.19	2.30	2.40	2.50	2.59	2.68	2.77	2.86	2.94	3.02	3.10	3.17	3.25	3.32	3.39	3.46

## TVI 80° - Hollow Cone

	5 Bar	10 Bar	15 Bar
TVI-80005	XC	C	C
TVI-800075	XC	C	C
TVI-80015	XC	C	C
TVI-8002	XC	XC	VC
TVI-80025	XC	XC	VC

Albu<sup>z</sup>® is a registered trademark of SAINT-GOBAIN SOLCERA, SAINT GOBAIN CERAMIQUES AVANCEES DESMARQUEST, CERAMIQUES TECHNIQUES DESMARQUEST, and SOCIETE DESMARQUEST ET CEC.  
Hypro® is a registered trademark of Pentair.



# Flat Fans - Ceramic AVI 80°



The AVI 80° air-inducing fan pattern spray nozzle is ideal for use in directed spray applications and on air-blast sprayers. Research shows AVI spray nozzles can be used to deliver more spray on target with less loss to airborne drift and to the ground than conventional applications.

- Ceramic orifice for extra long life and accuracy
- Venturi design delivers more spray on-target
- Color coded for simple selection
- 110° fan model ideal for broadcast spraying (See page 142 for more info.)

## US Units

Spray Nozzle	Flow Rate, GPM at Pressure, PSI												
	40	50	60	70	80	90	100	120	150	200	250	300	350
01	0.100	0.112	0.122	0.132	0.141	0.150	0.158	0.173	0.194	0.224	0.250	0.274	0.296
015	0.150	0.168	0.184	0.198	0.212	0.225	0.237	0.260	0.290	0.335	0.375	0.411	0.444
02	0.200	0.224	0.245	0.265	0.283	0.300	0.316	0.346	0.387	0.447	0.500	0.548	0.592
025	0.250	0.280	0.306	0.331	0.354	0.375	0.395	0.433	0.484	0.559	0.625	0.685	0.740
03	0.300	0.335	0.367	0.397	0.424	0.450	0.474	0.520	0.581	0.671	0.750	0.822	0.887
04	0.400	0.447	0.490	0.529	0.566	0.600	0.632	0.693	0.775	0.894	1.000	1.095	1.183

## Metric Units

Spray Nozzle	Flow Rate, LPM at Pressure, Bar												
	2.1	2.8	3.4	4.1	4.8	5.5	6.9	8.3	10.3	13.8	17.2	20.7	24.1
01	0.329	0.379	0.424	0.462	0.500	0.534	0.598	0.655	0.734	0.848	0.946	1.037	1.120
015	0.492	0.568	0.636	0.697	0.750	0.803	0.897	0.984	1.098	1.268	1.420	1.556	1.681
02	0.655	0.757	0.848	0.927	1.003	1.071	1.196	1.310	1.465	1.692	1.893	2.074	2.241
025	0.821	0.946	1.060	1.158	1.253	1.340	1.495	1.639	1.832	2.116	2.366	2.593	2.801
03	0.984	1.136	1.268	1.389	1.503	1.605	1.794	1.968	2.199	2.540	2.839	3.112	3.358
04	1.310	1.514	1.692	1.855	2.002	2.143	2.392	2.623	2.934	3.384	3.785	4.145	4.478

Features	
Common Use	Plant Health
Pattern	Tapered Flat Fan
Technology	Air Induction
Material	Ceramic
Spray Angle	80°
Pressure Range	40-350 PSI (3-24 BAR)
Configuration	Nozzle
Part Numbers	
Nozzles 80°	Caps (25 Pack)
AVI-8001	CAP01-01
AVI-80015	CAP01-015
AVI-8002	CAP01-02
AVI-80025	CAP01-025
AVI-8003	CAP01-03
AVI-8004	CAP01-04



# Flat Fan - Ceramic AXI 80°



The AXI 80° extended range fan pattern nozzle can be used for directed applications of a variety of chemistries and products. They are well suited to applications where smaller droplets are favored. They are equipped with a ceramic orifice to provide long-lasting performance.

- Ceramic orifice for extra long life
- Simple, reliable design
- Color coded for simple selection
- FastCap includes nozzle, cap and gasket
- 110° fan model ideal for broadcast spraying (See page 154 for more info.)

## US Units

Spray Nozzle	Flow Rate, GPM at Pressure, PSI												
	40	50	60	70	80	90	100	120	150	200	250	300	350
01	0.100	0.112	0.122	0.132	0.141	0.150	0.158	0.173	0.194	0.224	0.250	0.274	0.296
015	0.150	0.168	0.184	0.198	0.212	0.225	0.237	0.260	0.290	0.335	0.375	0.411	0.444
02	0.200	0.224	0.245	0.265	0.283	0.300	0.316	0.346	0.387	0.447	0.500	0.548	0.592
025	0.250	0.280	0.306	0.331	0.354	0.375	0.395	0.433	0.484	0.559	0.625	0.685	0.740
03	0.300	0.335	0.367	0.397	0.424	0.450	0.474	0.520	0.581	0.671	0.750	0.822	0.887
04	0.400	0.447	0.490	0.529	0.566	0.600	0.632	0.693	0.775	0.894	1.000	1.095	1.183
05	0.500	0.559	0.612	0.661	0.707	0.750	0.791	0.866	0.968	1.118	1.250	1.369	1.479
06	0.600	0.671	0.735	0.794	0.849	0.900	0.949	1.039	1.162	1.342	1.500	1.643	1.775

## Metric Units

Spray Nozzle	Flow Rate, LPM at Pressure, Bar												
	1.4	2.8	3.4	4.1	4.8	5.5	6.9	8.3	10.3	13.8	17.2	20.7	24.1
01	0.269	0.379	0.424	0.462	0.500	0.534	0.598	0.655	0.734	0.848	0.946	1.037	1.120
015	0.401	0.568	0.636	0.697	0.750	0.803	0.897	0.984	1.098	1.268	1.420	1.556	1.681
02	0.534	0.757	0.848	0.927	1.003	1.071	1.196	1.310	1.465	1.692	1.893	2.074	2.241
025	0.670	0.946	1.060	1.158	1.253	1.340	1.495	1.639	1.832	2.116	2.366	2.593	2.801
03	0.803	1.136	1.268	1.389	1.503	1.605	1.794	1.968	2.199	2.540	2.839	3.112	3.358
04	1.071	1.514	1.692	1.855	2.002	2.143	2.392	2.623	2.934	3.384	3.785	4.145	4.478
05	1.340	1.893	2.116	2.317	2.502	2.676	2.994	3.278	3.664	4.232	4.732	5.182	5.599
06	1.605	2.271	2.540	2.782	3.006	3.214	3.592	3.933	4.399	5.080	5.678	6.219	6.719

Features	
Common Use	Plant Health
Pattern	Tapered Flat Fan
Technology	Elliptical Orifice
Material	Ceramic
Spray Angle	80°
Pressure Range	40-350 PSI [3-24 BAR]
Configuration	Nozzle, Fast Cap
Part Numbers	
Nozzles 80°	FastCaps 80°
AXI-80015	FC-AXI-80015
AXI-8002	FC-AXI-8002
AXI-8003	FC-AXI-8003
AXI-8004	FC-AXI-8004
AXI-8005	FC-AXI-8005
AXI-8006	FC-AXI-8006



# Full Cone - Ceramic Discs & Cores 14°-71°



Albuz® Ceramic discs and cores are the longest lasting disc-core nozzles, making them ideal for abrasive agricultural and horticultural sprays. DCC/ CRC nozzles will outlast stainless steel disc-core nozzles by up to 10 times and perform superbly at high pressures common on many air-blast and directed sprayers.

## US Units

DISC	Full Cone CORE	Flow Rate GPM at Pressure, PSI										Spray Angle Degrees Pressure, PSI		
		10	20	30	40	60	80	100	150	200	300	20	40	80
DCC-01	CRC-31	0.08	0.11	0.13	0.15	0.18	0.20	0.23	0.27	0.31	0.37	49	47	43
DCC-02	CRC-31	0.12	0.16	0.19	0.22	0.26	0.30	0.33	0.40	0.45	0.55	62	63	61
DCC-03	CRC-31	0.13	0.18	0.21	0.24	0.29	0.33	0.37	0.44	0.50	0.6	63	65	63
DCC-01	CRC-35	0.08	0.11	0.13	0.14	0.17	0.2	0.22	0.26	0.29	0.35	19	23	26
DCC-02	CRC-35	0.14	0.18	0.24	0.25	0.3	0.34	0.37	0.45	0.51	0.60	40	44	47
DCC-03	CRC-35	0.16	0.22	0.26	0.30	0.36	0.41	0.45	0.55	0.62	0.74	45	50	52
DCC-04	CRC-35	0.27	0.37	0.44	0.50	0.60	0.70	0.79	0.93	1.10	1.30	68	70	71
DCC-05	CRC-35	0.34	0.48	0.58	0.66	0.8	0.92	1.00	1.20	1.40	1.70	67	69	71
DCC-02	CRC-56	-	-	0.21	0.25	0.3	0.35	0.39	0.47	5.50	0.67	-	14	17
DCC-03	CRC-56	-	-	0.29	0.34	0.41	0.48	0.53	0.65	7.50	0.92	-	20	23
DCC-04	CRC-56	-	0.39	0.48	0.55	0.67	0.78	0.87	1.10	1.20	1.50	20	26	29
DCC-05	CRC-56	0.38	0.54	0.66	0.76	0.93	1.10	1.20	1.50	1.70	2.10	26	32	34
DCC-06	CRC-56	0.55	0.78	0.95	1.10	1.40	1.60	1.70	2.10	2.50	3.00	34	39	41
DCC-07	CRC-56	0.76	1.10	1.30	1.50	1.90	2.20	2.40	2.90	3.40	4.20	45	52	54

## Metric Units

DISC	Full Cone CORE	Flow Rate GPM at Pressure, Bar							Spray Angle Degrees Pressure, Bar	
		3	4	5	6	10	15	20	10	20
DCC-01	CRC-31	-	-	-	-	1.0	1.2	1.4	38	40
DCC-02	CRC-31	-	-	-	-	1.5	1.8	2.0	49	54
DCC-03	CRC-31	-	-	-	-	1.6	1.9	2.2	58	67
DCC-01	CRC-35	-	-	-	-	1.0	1.2	1.3	27	27
DCC-02	CRC-35	-	-	-	-	1.7	2.0	2.2	40	45
DCC-03	CRC-35	-	-	-	-	2.0	2.4	2.8	42	48
DCC-04	CRC-35	-	-	-	-	3.5	4.2	4.8	60	68
DCC-05	CRC-35	2.6	3.0	3.3	3.6	4.5	5.5	6.3	62	69
DCC-02	CRC-56	1.0	1.1	1.2	1.4	1.8	2.2	2.5	16	18
DCC-03	CRC-56	1.3	1.6	1.7	1.9	2.4	3.0	3.4	22	24
DCC-04	CRC-56	2.2	2.5	2.8	3.1	4.0	4.8	5.6	28	30
DCC-05	CRC-56	3.0	3.5	3.9	4.3	5.5	6.7	7.8	33	35
DCC-06	CRC-56	4.5	5.3	5.9	6.5	8.5	10.2	11.9	38	40
DCC-07	CRC-56	6.0	6.9	7.7	8.5	11.0	13.5	15.6	51	53

Features		
Common Use	Plant Health	
Pattern	Full Cone	
Technology	Swirl	
Material	Ceramic	
Spray Angle	14°-71°	
Pressure Range	10-300 PSI (1-20 BAR)	
Configuration	Nozzle	
Part Numbers		
Discs	Cores	Caps (25 Pack)
DCC-01	CRC-31	CAP05-20
DCC-02	CRC-35	CAP05-20
DCC-03	CRC-56	CAP05-20
DCC-04	-	CAP05-20
DCC-05	-	CAP05-20
DCC-06	-	CAP05-20
DCC-07	-	CAP05-20



# Full Cone Directed - FCX 80°

The FCX full-cone spray nozzle is especially suited for coverage sensitive applications of insecticide/fungicides.



- Full cone pattern to give superior coverage with non-air induced droplets
- 80° spray angle makes the product easy to direct for spot applications
- Broad operating range for application flexibility

## US Units

Nozzle Size	Pressure (PSI)	Flow Rate (GPM)	Gallons per Acre 20 inch nozzle spacing MPH								GAL/1000 <sup>ft</sup> 20 inch nozzle spacing			
			4	5	6	8	10	12	15	20	2	3	4	5
02	15	0.20	14.9	11.9	9.9	7.4	5.9	5.0	4.0	3.0	0.68	0.45	0.34	0.27
	20	0.23	17.1	13.7	11.4	8.5	6.8	5.7	4.6	3.4	0.78	0.52	0.39	0.31
	30	0.28	20.8	16.6	13.9	10.4	8.3	6.9	5.5	4.2	0.95	0.64	0.48	0.38
	40	0.33	24.5	19.6	16.3	12.3	9.8	8.2	6.5	4.9	1.13	0.75	0.56	0.45
	50	0.37	27.5	22.0	18.3	13.7	11.0	9.2	7.3	5.5	1.26	0.84	0.63	0.50
	60	0.40	29.7	23.8	19.8	14.9	11.9	9.9	7.9	5.9	1.36	0.91	0.68	0.55
	70	0.43	31.9	25.5	21.3	16.0	12.8	10.6	8.5	6.4	1.47	0.98	0.73	0.59
	80	0.46	34.2	27.3	22.8	17.1	13.7	11.4	9.1	6.8	1.57	1.05	0.78	0.63
	100	0.52	38.6	30.9	25.7	19.3	15.4	12.9	10.3	7.7	1.77	1.18	0.89	0.71
	125	0.58	43.1	34.5	28.7	21.5	17.2	14.4	11.5	8.6	1.98	1.32	0.99	0.79
150	0.63	46.8	37.4	31.2	23.4	18.7	15.6	12.5	9.4	2.15	1.43	1.07	0.86	
03	15	0.30	22.3	17.8	14.9	11.1	8.9	7.4	5.9	4.5	1.02	0.68	0.51	0.41
	20	0.35	26.0	20.8	17.3	13.0	10.4	8.7	6.9	5.2	1.19	0.80	0.60	0.48
	30	0.42	31.2	24.9	20.8	15.6	12.5	10.4	8.3	6.2	1.43	0.95	0.72	0.57
	40	0.49	36.4	29.1	24.3	18.2	14.6	12.1	9.7	7.3	1.67	1.11	0.84	0.67
	50	0.55	40.8	32.7	27.2	20.4	16.3	13.6	10.9	8.2	1.88	1.25	0.94	0.75
	60	0.60	44.6	35.6	29.7	22.3	17.8	14.9	11.9	8.9	2.05	1.36	1.02	0.82
	70	0.65	48.3	38.6	32.2	24.1	19.3	16.1	12.9	9.7	2.22	1.48	1.11	0.89
	80	0.69	51.2	41.0	34.2	25.6	20.5	17.1	13.7	10.2	2.35	1.57	1.18	0.94
	100	0.77	57.2	45.7	38.1	28.6	22.9	19.1	15.2	11.4	2.63	1.75	1.31	1.05
	125	0.87	64.6	51.7	43.1	32.3	25.8	21.5	17.2	12.9	2.97	1.98	1.48	1.19
150	0.95	70.5	56.4	47.0	35.3	28.2	23.5	18.8	14.1	3.24	2.16	1.62	1.30	
04	15	0.40	29.7	23.8	19.8	14.9	11.9	9.9	7.9	5.9	1.36	0.91	0.68	0.55
	20	0.46	34.2	27.3	22.8	17.1	13.7	11.4	9.1	6.8	1.57	1.05	0.78	0.63
	30	0.57	42.3	33.9	28.2	21.2	16.9	14.1	11.3	8.5	1.94	1.30	0.97	0.78
	40	0.65	48.3	38.6	32.2	24.1	19.3	16.1	12.9	9.7	2.22	1.48	1.11	0.89
	50	0.73	54.2	43.4	36.1	27.1	21.7	18.1	14.5	10.8	2.49	1.66	1.24	1.00
	60	0.80	59.4	47.5	39.6	29.7	23.8	19.8	15.8	11.9	2.73	1.82	1.36	1.09
	70	0.86	63.9	51.1	42.6	31.9	25.5	21.3	17.0	12.8	2.93	1.96	1.47	1.17
	80	0.92	68.3	54.6	45.5	34.2	27.3	22.8	18.2	13.7	3.14	2.09	1.57	1.25
	100	1.03	76.5	61.2	51.0	38.2	30.6	25.5	20.4	15.3	3.51	2.34	1.76	1.40
	125	1.15	85.4	68.3	56.9	42.7	34.2	28.5	22.8	17.1	3.92	2.61	1.96	1.57
150	1.26	93.6	74.8	62.4	46.8	37.4	31.2	24.9	18.7	4.30	2.86	2.15	1.72	
05	15	0.50	37.1	29.7	24.8	18.6	14.9	12.4	9.9	7.4	1.71	1.14	0.85	0.68
	20	0.58	43.1	34.5	28.7	21.5	17.2	14.4	11.5	8.6	1.98	1.32	0.99	0.79
	30	0.71	52.7	42.2	35.1	26.4	21.1	17.6	14.1	10.5	2.42	1.61	1.21	0.97
	40	0.82	60.9	48.7	40.6	30.4	24.4	20.3	16.2	12.2	2.80	1.86	1.40	1.12
	50	0.91	67.6	54.1	45.0	33.8	27.0	22.5	18.0	13.5	3.10	2.07	1.55	1.24
	60	1.00	74.3	59.4	49.5	37.1	29.7	24.8	19.8	14.9	3.41	2.27	1.71	1.36
	70	1.08	80.2	64.2	53.5	40.1	32.1	26.7	21.4	16.0	3.68	2.46	1.84	1.47
	80	1.15	85.4	68.3	56.9	42.7	34.2	28.5	22.8	17.1	3.92	2.61	1.96	1.57
	100	1.29	95.8	76.6	63.9	47.9	38.3	31.9	25.5	19.2	4.40	2.93	2.20	1.76
	125	1.44	107	85.5	71.3	53.5	42.8	35.6	28.5	21.4	4.91	3.27	2.46	1.96
150	1.58	117	93.9	78.2	58.7	46.9	39.1	31.3	23.5	5.39	3.59	2.69	2.16	
06	15	0.60	44.6	35.6	29.7	22.3	17.8	14.9	11.9	8.9	2.05	1.36	1.02	0.82
	20	0.69	51.2	41.0	34.2	25.6	20.5	17.1	13.7	10.2	2.35	1.57	1.18	0.94
	30	0.85	63.1	50.5	42.1	31.6	25.2	21.0	16.8	12.6	2.90	1.93	1.45	1.16
	40	0.98	72.8	58.2	48.5	36.4	29.1	24.3	19.4	14.6	3.34	2.23	1.67	1.34
	50	1.10	81.7	65.3	54.5	40.8	32.7	27.2	21.8	16.3	3.75	2.50	1.88	1.50
	60	1.20	89.1	71.3	59.4	44.6	35.6	29.7	23.8	17.8	4.09	2.73	2.05	1.64
	70	1.30	96.5	77.2	64.4	48.3	38.6	32.2	25.7	19.3	4.43	2.96	2.22	1.77
	80	1.39	103	82.6	68.8	51.6	41.3	34.4	27.5	20.6	4.74	3.16	2.37	1.90
	100	1.55	115	92.1	76.7	57.5	46.0	38.4	30.7	23.0	5.29	3.52	2.64	2.11
	125	1.73	128	103	85.6	64.2	51.4	42.8	34.3	25.7	5.90	3.93	2.95	2.36
150	1.90	141	113	94.1	70.5	56.4	47.0	37.6	28.2	6.48	4.32	3.24	2.59	





**Metric Units**

Nozzle Size	Pressure (BAR)	Flow Rate (LPM)	Flow L/min- 50 cm Spacing KMH							
			7	8	10	12	15	20	25	30
02	1	0,74	127	111	89	74	59	44	36	30
	2	1,05	180	158	126	105	84	63	50	42
	3	1,28	219	192	154	128	102	77	61	51
	4	1,48	254	222	178	148	118	89	71	59
	5	1,65	283	248	198	165	132	99	79	66
	6	1,81	310	272	217	181	145	109	87	72
	7	1,96	336	294	235	196	157	118	94	78
	8	2,09	358	314	251	209	167	125	100	84
	9	2,22	381	333	266	222	178	133	107	89
	10	2,34	401	351	281	234	187	140	112	94
03	1	1,12	192	168	134	112	90	67	54	45
	2	1,58	271	237	190	158	126	95	76	63
	3	1,94	333	291	233	194	155	116	93	78
	4	2,23	382	335	268	223	178	134	107	89
	5	2,50	429	375	300	250	200	150	120	100
	6	2,73	468	410	328	273	218	164	131	109
	7	2,96	507	444	355	296	237	178	142	118
	8	3,17	543	476	380	317	254	190	152	127
	9	3,36	576	504	403	336	269	202	161	134
	10	3,54	607	531	425	354	283	212	170	142
04	1	1,49	255	224	179	149	119	89	72	60
	2	2,11	362	317	253	211	169	127	101	84
	3	2,58	442	387	310	258	206	155	124	103
	4	2,98	511	447	358	298	238	179	143	119
	5	3,33	571	500	400	333	266	200	160	133
	6	3,65	626	548	438	365	292	219	175	146
	7	3,94	675	591	473	394	315	236	189	158
	8	4,21	722	632	505	421	337	253	202	168
	9	4,47	766	671	536	447	358	268	215	179
	10	4,71	807	707	565	471	377	283	226	188
05	1	1,86	319	279	223	186	149	112	89	74
	2	2,63	451	395	316	263	210	158	126	105
	3	3,22	552	483	386	322	258	193	155	129
	4	3,72	638	558	446	372	298	223	179	149
	5	4,16	713	624	499	416	333	250	200	166
	6	4,56	782	684	547	456	365	274	219	182
	7	4,92	843	738	590	492	394	295	236	197
	8	5,26	902	789	631	526	421	316	252	210
	9	5,58	957	837	670	558	446	335	268	223
	10	5,88	1008	882	706	588	470	353	282	235
06	1	2,23	382	335	268	223	178	134	107	89
	2	3,15	540	473	378	315	252	189	151	126
	3	3,86	662	579	463	386	309	232	185	154
	4	4,45	763	668	534	445	356	267	214	178
	5	4,98	854	747	598	498	398	299	239	199
	6	5,45	934	818	654	545	436	327	262	218
	7	5,89	1010	884	707	589	471	353	283	236
	8	6,29	1078	944	755	629	503	377	302	252
	9	6,69	1147	1004	803	669	535	401	321	268
	10	7,05	1209	1058	846	705	564	423	338	282

Features	
Common Use	Plant Health
Pattern	Full Cone
Technology	Swirl
Material	Polyacetal
Spray Angle	80°
Pressure Range	15-150 PSI (1-10 BAR)
Configuration	Nozzle
Part Numbers	
Nozzles 80°	Caps (25 Pack)
30FCX02	CAP04-02
30FCX03	CAP04-03
30FCX04	CAP04-04
30FCX05	CAP04-05
30FCX06	CAP04-06



# Even 80°



The Hypro® Even Flat Fan spray nozzle is an excellent choice for banding and directed post application. An even spray pattern should be used when banding chemicals.

- Commonly used in hand-held applications
- Even spray pattern provides a precise application rate where no spray overlap is desired
- Large range of flow rates available to meet your application requirements

## US Units

Nozzle Size	Droplet Size	Pressure (PSI)	Flow Rate (GPM)	Gallons per Acre 10 inch band MPH				Gallons per Acre 12 inch band MPH				Gallons per Acre 15 inch band MPH			
				4	5	6	7	4	5	6	7	4	5	6	7
01	F	30	0.09	13.4	10.7	8.9	7.6	11.1	8.9	7.4	6.4	8.9	7.1	5.9	5.1
	F	40	0.10	14.9	11.9	9.9	8.5	12.4	9.9	8.3	7.1	9.9	7.9	6.6	5.7
	VF	50	0.11	16.3	13.1	10.9	9.3	13.6	10.9	9.1	7.8	10.9	8.7	7.3	6.2
	VF	60	0.12	17.8	14.3	11.9	10.2	14.9	11.9	9.9	8.5	11.9	9.5	7.9	6.8
015	F	30	0.13	19.3	15.4	12.9	11.0	16.1	12.9	10.7	9.2	12.9	10.3	8.6	7.4
	F	40	0.15	22.3	17.8	14.9	12.7	18.6	14.9	12.4	10.6	14.9	11.9	9.9	8.5
	VF	50	0.17	25.2	20.2	16.8	14.4	21.0	16.8	14.0	12.0	16.8	13.5	11.2	9.6
	VF	60	0.18	26.7	21.4	17.8	15.3	22.3	17.8	14.9	12.7	17.8	14.3	11.9	10.2
02	M	30	0.17	25.2	20.2	16.8	14.4	21.0	16.8	14.0	12.0	16.8	13.5	11.2	9.6
	F	40	0.20	29.7	23.8	19.8	17.0	24.8	19.8	16.5	14.1	19.8	15.8	13.2	11.3
	F	50	0.22	32.7	26.1	21.8	18.7	27.2	21.8	18.2	15.6	21.8	17.4	14.5	12.4
	F	60	0.24	35.6	28.5	23.8	20.4	29.7	23.8	19.8	17.0	23.8	19.0	15.8	13.6
03	M	30	0.26	38.6	30.9	25.7	22.1	32.2	25.7	21.5	18.4	25.7	20.6	17.2	14.7
	F	40	0.30	44.6	35.6	29.7	25.5	37.1	29.7	24.8	21.2	29.7	23.8	19.8	17.0
	F	50	0.34	50.5	40.4	33.7	28.9	42.1	33.7	28.1	24.0	33.7	26.9	22.4	19.2
	F	60	0.37	54.9	44.0	36.6	31.4	45.8	36.6	30.5	26.2	36.6	29.3	24.4	20.9
04	M	30	0.35	52.0	41.6	34.7	29.7	43.3	34.7	28.9	24.8	34.7	27.7	23.1	19.8
	M	40	0.40	59.4	47.5	39.6	33.9	49.5	39.6	33.0	28.3	39.6	31.7	26.4	22.6
	F	50	0.45	66.8	53.5	44.6	38.2	55.7	44.6	37.1	31.8	44.6	35.6	29.7	25.5
	F	60	0.49	72.8	58.2	48.5	41.6	60.6	48.5	40.4	34.7	48.5	38.8	32.3	27.7
05	M	30	0.43	63.9	51.1	42.6	36.5	53.2	42.6	35.5	30.4	42.6	34.1	28.4	24.3
	M	40	0.50	74.3	59.4	49.5	42.4	61.9	49.5	41.3	35.4	49.5	39.6	33.0	28.3
	M	50	0.56	83.2	66.5	55.4	47.5	69.3	55.4	46.2	39.6	55.4	44.4	37.0	31.7
	F	60	0.61	90.6	72.5	60.4	51.8	75.5	60.4	50.3	43.1	60.4	48.3	40.3	34.5
06	C	30	0.52	77.2	61.8	51.5	44.1	64.4	51.5	42.9	36.8	51.5	41.2	34.3	29.4
	C	40	0.60	89.1	71.3	59.4	50.9	74.3	59.4	49.5	42.4	59.4	47.5	39.6	33.9
	C	50	0.67	99.5	79.6	66.3	56.9	82.9	66.3	55.3	47.4	66.3	53.1	44.2	37.9
	C	60	0.73	108	86.7	72.3	61.9	90.3	72.3	60.2	51.6	72.3	57.8	48.2	41.3
08	VC	30	0.69	102	82.0	68.3	58.6	85.4	68.3	56.9	48.8	68.3	54.6	45.5	39.0
	C	40	0.80	119	95.0	79.2	67.9	99.0	79.2	66.0	56.6	79.2	63.4	52.8	45.3
	C	50	0.89	132	106	88.1	75.5	110	88.1	73.4	62.9	88.1	70.5	58.7	50.3
	C	60	0.98	146	116	97.0	83.2	121	97.0	80.9	69.3	97.0	77.6	64.7	55.4

Droplet size based on ASABE S572.1 standard.

Features	
Common Use	Weeds
Pattern	Even Flat Fan
Technology	Elliptical Orifice
Material	Polyacetal
Spray Angle	80°
Pressure Range	30-60 PSI (2-4 BAR)
Configuration	Nozzle
Part Numbers	
Nozzles 80°	Caps (25 Pack)
E80-01	CAP00-01
E80-015	CAP00-015
E80-02	CAP00-02
E80-03	CAP00-03
E80-04	CAP00-04
E80-05	CAP00-05
E80-06	CAP00-06
E80-08	CAP00-08

## Metric Units

Nozzle Size	Droplet Size	Pressure (BAR)	Flow Rate (LPM)	In-Band Application Rate (L/Ha) 25 cm [km/h]				In-Band Application Rate (L/Ha) 30 cm [km/h]				In-Band Application Rate (L/Ha) 40 cm [km/h]			
				6	8	10	12	6	8	10	12	6	8	10	12
01	F	2	0.33	132	99	79	66	110	83	66	55	83	62	50	41
	F	2.5	0.37	148	111	89	74	123	93	74	62	93	69	56	46
	F	3	0.40	160	120	96	80	133	100	80	67	100	75	60	50
	VF	4	0.46	184	138	110	92	153	115	92	77	115	86	69	58
015	F	2	0.49	196	147	118	98	163	123	98	82	123	92	74	61
	F	2.5	0.55	220	165	132	110	183	138	110	92	138	103	83	69
	F	3	0.60	240	180	144	120	200	150	120	100	150	113	90	75
	VF	4	0.69	276	207	166	138	230	173	138	115	173	129	104	86
02	M	2	0.65	260	195	156	130	217	163	130	108	163	122	98	81
	F	2.5	0.73	292	219	175	146	243	183	146	122	183	137	110	91
	F	3	0.80	320	240	192	160	267	200	160	133	200	150	120	100
	F	4	0.92	368	276	221	184	307	230	184	153	230	173	138	115
03	M	2	0.98	392	294	235	196	327	245	196	163	245	184	147	123
	M	2.5	1.10	440	330	264	220	367	275	220	183	275	206	165	138
	F	3	1.20	480	360	288	240	400	300	240	200	300	225	180	150
	F	4	1.39	556	417	334	278	463	348	278	232	348	261	209	174
04	M	2	1.31	524	393	314	262	437	328	262	218	328	246	197	164
	M	2.5	1.46	584	438	350	292	487	365	292	243	365	274	219	183
	M	3	1.60	640	480	384	320	533	400	320	267	400	300	240	200
	F	4	1.85	740	555	444	370	617	463	370	308	463	347	278	231
05	M	2	1.63	652	489	391	326	543	408	326	272	408	306	245	204
	M	2.5	1.83	732	549	439	366	610	458	366	305	458	343	275	229
	M	3	2.00	800	600	480	400	667	500	400	333	500	375	300	250
	F	4	2.31	924	693	554	462	770	578	462	385	578	433	347	289
06	C	2	1.96	784	588	470	392	653	490	392	327	490	368	294	245
	C	2.5	2.19	876	657	526	438	730	548	438	365	548	411	329	274
	C	3	2.40	960	720	576	480	800	600	480	400	600	450	360	300
	C	4	2.77	1108	831	665	554	923	693	554	462	693	519	416	346
08	VC	2	2.61	1044	783	626	522	870	653	522	435	653	489	392	326
	C	2.5	2.92	1168	876	701	584	973	730	584	487	730	548	438	365
	C	3	3.20	1280	960	768	640	1067	800	640	533	800	600	480	400
	C	4	3.70	1480	1110	888	740	1233	925	740	617	925	694	555	463

Droplet size based on ASABE S572.1 standard.



# Brass Off-Center OC 80°



The Hypro® OC flat fan off-center brass spray nozzle is an economical nozzle for spraying around obstacles or defining the edge of a spray swath.

- Creates half of a broadcast pattern
- Generally positioned at the end of a boom
- Designed for use with overlapping broadcast patterns to provide precise width control

## US Units

Nozzle Size	Droplet Size 80°	Pressure (PSI)	Flow Rate (GPM)	Gallons per Acre 20 inch nozzle spacing MPH								GAL/1000 <sup>F12</sup> 20 inch nozzle spacing			
				4	5	6	8	10	12	15	20	2	3	4	5
02	M	30	0.17	12.6	10.1	8.4	6.3	5.0	4.2	3.4	2.5	0.58	0.39	0.29	0.23
	F	40	0.20	14.9	11.9	9.9	7.4	5.9	5.0	4.0	3.0	0.68	0.45	0.34	0.27
	F	50	0.22	16.3	13.1	10.9	8.2	6.5	5.4	4.4	3.3	0.75	0.50	0.38	0.30
	F	60	0.24	17.8	14.3	11.9	8.9	7.1	5.9	4.8	3.6	0.82	0.55	0.41	0.33
03	M	30	0.26	19.3	15.4	12.9	9.7	7.7	6.4	5.1	3.9	0.89	0.59	0.44	0.35
	F	40	0.30	22.3	17.8	14.9	11.1	8.9	7.4	5.9	4.5	1.02	0.68	0.51	0.41
	F	50	0.34	25.2	20.2	16.8	12.6	10.1	8.4	6.7	5.0	1.16	0.77	0.58	0.46
	F	60	0.37	27.5	22.0	18.3	13.7	11.0	9.2	7.3	5.5	1.26	0.84	0.63	0.50
04	M	30	0.35	26.0	20.8	17.3	13.0	10.4	8.7	6.9	5.2	1.19	0.80	0.60	0.48
	M	40	0.40	29.7	23.8	19.8	14.9	11.9	9.9	7.9	5.9	1.36	0.91	0.68	0.55
	M	50	0.45	33.4	26.7	22.3	16.7	13.4	11.1	8.9	6.7	1.53	1.02	0.77	0.61
	F	60	0.49	36.4	29.1	24.3	18.2	14.6	12.1	9.7	7.3	1.67	1.11	0.84	0.67
06	C	30	0.52	38.6	30.9	25.7	19.3	15.4	12.9	10.3	7.7	1.77	1.18	0.89	0.71
	M	40	0.60	44.6	35.6	29.7	22.3	17.8	14.9	11.9	8.9	2.05	1.36	1.02	0.82
	M	50	0.67	49.7	39.8	33.2	24.9	19.9	16.6	13.3	9.9	2.28	1.52	1.14	0.91
	M	60	0.73	54.2	43.4	36.1	27.1	21.7	18.1	14.5	10.8	2.49	1.66	1.24	1.00
08	C	30	0.69	51.2	41.0	34.2	25.6	20.5	17.1	13.7	10.2	2.35	1.57	1.18	0.94
	M	40	0.80	59.4	47.5	39.6	29.7	23.8	19.8	15.8	11.9	2.73	1.82	1.36	1.09
	M	50	0.89	66.1	52.9	44.1	33.0	26.4	22.0	17.6	13.2	3.03	2.02	1.52	1.21
	M	60	0.98	72.8	58.2	48.5	36.4	29.1	24.3	19.4	14.6	3.34	2.23	1.67	1.34
12	C	30	1.04	77.2	61.8	51.5	38.6	30.9	25.7	20.6	15.4	3.55	2.36	1.77	1.42
	C	40	1.20	89.1	71.3	59.4	44.6	35.6	29.7	23.8	17.8	4.09	2.73	2.05	1.64
	C	50	1.34	99.5	79.6	66.3	49.7	39.8	32.2	26.5	19.9	4.57	3.05	2.28	1.83
	M	60	1.47	109	87.3	72.8	54.6	43.7	36.4	29.1	21.8	5.01	3.34	2.51	2.01
16	C	30	1.39	103	82.6	68.8	51.6	41.3	34.4	27.5	20.6	4.74	3.16	2.37	1.90
	C	40	1.60	119	95.0	79.2	59.4	47.5	39.6	31.7	23.8	5.46	3.64	2.73	2.18
	C	50	1.79	133	106	88.6	66.5	53.2	44.3	35.4	26.6	6.10	4.07	3.05	2.44
	C	60	1.96	146	116	97.0	72.8	58.2	48.5	38.8	29.1	6.68	4.46	3.34	2.67

Droplet size based on ASABE S572.1 standard.

Features	
Common Use	Unspecialized
Pattern	Off-Center Fan
Technology	Elliptical Orifice
Material	Brass
Spray Angle	80°
Pressure Range	30-60 PSI (2-4 BAR)
Configuration	Nozzle
Part Numbers	
Nozzles 80°	Caps (25 Pack)
280C02	CAP00-20
280C03	CAP00-20
280C04	CAP00-20
280C06	CAP00-20
280C08	CAP00-20
280C12	CAP00-20
280C16	CAP00-20

## Metric Units

Nozzle Size	Droplet Size 80°	Pressure (BAR)	Flow Rate (LPM)	Application Rate L/Ha - 50 cm Spacing KM/H							
				7	8	10	12	15	20	25	30
02	M	2	0.65	130	98	78	65	52	39	31	26
	F	2.5	0.73	146	110	88	73	58	44	35	29
	F	3	0.80	160	120	96	80	64	48	38	32
	F	4	0.92	184	138	110	92	74	55	44	37
03	M	2	0.98	196	147	118	98	78	59	47	39
	M	2.5	1.10	220	165	132	110	88	66	53	44
	F	3	1.20	240	180	144	120	96	72	58	48
	F	4	1.39	278	209	167	139	111	83	67	56
04	M	2	1.31	262	197	157	131	105	79	63	52
	M	2.5	1.46	292	219	175	146	117	88	70	58
	M	3	1.60	320	240	192	160	128	96	77	64
	F	4	1.85	370	278	222	185	148	111	89	74
06	C	2	1.96	392	294	235	196	157	118	94	78
	M	2.5	2.19	438	329	263	219	175	131	105	88
	M	3	2.40	480	360	288	240	192	144	115	96
	M	4	2.77	554	416	332	277	222	166	133	111
08	C	2	2.61	522	392	313	261	209	157	125	104
	M	2.5	2.92	584	438	350	292	234	175	140	117
	M	3	3.20	640	480	384	320	256	192	154	128
	M	4	3.70	740	555	444	370	296	222	178	148
12	C	2	3.92	784	588	470	392	314	235	188	157
	C	2.5	4.38	876	657	526	438	350	263	210	175
	C	3	4.80	960	720	576	480	384	288	230	192
	M	4	5.54	1108	831	665	554	443	332	266	222
16	C	2	5.23	1046	785	628	523	418	314	251	209
	C	2.5	5.84	1168	876	701	584	467	350	280	234
	C	3	6.40	1280	960	768	640	512	384	307	256
	C	4	7.39	1478	1109	887	739	591	443	355	296

Droplet size based on ASABE S572.1 standard.



# Ceramic Off-Center OCI 80°



The Albuz® OCI off-center flat fan ceramic spray nozzle provides excellent wear life for spraying around obstacles or defining the edge of a spraying swath.

## US Units

Nozzle Size	Droplet Size 80°	Pressure (PSI)	Flow Rate (GPM)	Gallons per Acre 20 inch nozzle spacing MPH										GAL/1000ft <sup>2</sup> 20 inch nozzle spacing			
				4	5	6	8	10	12	15	20	2	3	4	5		
02	M	30	0.17	12.6	10.1	8.4	6.3	5.0	4.2	3.4	2.5	0.58	0.39	0.29	0.23		
	M	40	0.20	14.9	11.9	9.9	7.4	5.9	5.0	4.0	3.0	0.68	0.45	0.34	0.27		
	F	50	0.22	16.3	13.1	10.9	8.2	6.5	5.4	4.4	3.3	0.75	0.50	0.38	0.30		
03	M	30	0.26	19.3	15.4	12.9	9.7	7.7	6.4	5.1	3.9	0.89	0.59	0.44	0.35		
	M	40	0.30	22.3	17.8	14.9	11.1	8.9	7.4	5.9	4.5	1.02	0.68	0.51	0.41		
	M	50	0.34	25.2	20.2	16.8	12.6	10.1	8.4	6.7	5.0	1.16	0.77	0.58	0.46		
04	M	30	0.35	26.0	20.8	17.3	13.0	10.4	8.7	6.9	5.2	1.19	0.80	0.60	0.48		
	M	40	0.40	29.7	23.8	19.8	14.9	11.9	9.9	7.9	5.9	1.36	0.91	0.68	0.55		
	M	50	0.45	33.4	26.7	22.3	16.7	13.4	11.1	8.9	6.7	1.53	1.02	0.77	0.61		
	M	60	0.49	36.4	29.1	24.3	18.2	14.6	12.1	9.7	7.3	1.67	1.11	0.84	0.67		

## Metric Units

Nozzle Size	Droplet Size 80°	Pressure (Bar)	Flow Rate (LPM)	Liters/Hectare km/h															
				4	5	6	7	8	9	10	12	14	16	18	20				
02	M	2	0.65	195	156	130	111	98	87	78v	65	56	49	43	39				
	M	3	0.80	240	192	160	137	120	107	96	80	69	60	53	48				
	F	4	0.91	273	218	182	156	137	121	109	91	78	68	61	55				
03	M	2	0.98	294	235	196	168	147	131	118	98	84	74	65	59				
	M	3	1.20	360	288	240	206	180	160	144	120	103	90	80	72				
	M	4	1.39	417	334	278	238	209	185	167	139	119	104	93	83				
04	M	2	1.31	393	314	262	225	197	175	157	131	112	98	87	79				
	M	3	1.60	480	384	320	274	240	213	192	160	137	120	107	96				
	M	4	1.85	555	444	370	317	278	247	222	185	159	139	123	111				

Features	
Common Use	Unspecialized
Pattern	Off-Centered Fan
Technology	Elliptical Orifice
Material	Ceramic
Spray Angle	80°
Pressure Range	30-60 PSI (2-4 BAR)
Configuration	Nozzle
Part Numbers	
Nozzles 80°	Caps (25 Pack)
OCI-8002	CAP00-02
OCI-8003	CAP00-03
OCI-8004	CAP00-04



# Flat Fan - Ceramic AVI-OC 80°



The Albuz® AVI-OC air-inducing Venturi off-center ceramic spray nozzle with air suction provides large, air-filled droplets that burst on impact with target.

## US Units

Nozzle Size	Droplet Size 80°	Pressure (PSI)	Flow Rate (GPM)	Gallons per Acre 20 inch nozzle spacing MPH								GAL/1000ft <sup>2</sup> 20 inch nozzle spacing			
				4	5	6	8	10	12	15	20	2	3	4	5
015	VC	40	0.15	11.1	8.9	7.4	5.6	4.5	3.7	3.0	2.2	0.51	0.34	0.26	0.20
	VC	50	0.17	12.6	10.1	8.4	6.3	5.0	4.2	3.4	2.5	0.58	0.39	0.29	0.23
	VC	60	0.18	13.4	10.7	8.9	6.7	5.3	4.5	3.6	2.7	0.61	0.41	0.31	0.25
	VC	70	0.20	14.9	11.9	9.9	7.4	5.9	5.0	4.0	3.0	0.68	0.45	0.34	0.27
	VC	80	0.21	15.6	12.5	10.4	7.8	6.2	5.2	4.2	3.1	0.72	0.48	0.36	0.29
	C	90	0.23	17.1	13.7	11.4	8.5	6.8	5.7	4.6	3.4	0.78	0.52	0.39	0.31
	C	100	0.24	17.8	14.3	11.9	8.9	7.1	5.9	4.8	3.6	0.82	0.55	0.41	0.33
02	XC	40	0.20	14.9	11.9	9.9	7.4	5.9	5.0	4.0	3.0	0.68	0.45	0.34	0.27
	VC	50	0.22	16.3	13.1	10.9	8.2	6.5	5.4	4.4	3.3	0.75	0.50	0.38	0.30
	VC	60	0.24	17.8	14.3	11.9	8.9	7.1	5.9	4.8	3.6	0.82	0.55	0.41	0.33
	VC	70	0.26	19.3	15.4	12.9	9.7	7.7	6.4	5.1	3.9	0.89	0.59	0.44	0.35
	VC	80	0.28	20.8	16.6	13.9	10.4	8.3	6.9	5.5	4.2	0.95	0.64	0.48	0.38
	VC	90	0.30	22.3	17.8	14.9	11.1	8.9	7.4	5.9	4.5	1.02	0.68	0.51	0.41
	VC	100	0.32	23.8	19.0	15.8	11.9	9.5	7.9	6.3	4.8	1.09	0.73	0.55	0.44
025	XC	40	0.25	18.6	14.9	12.4	9.3	7.4	6.2	5.0	3.7	0.85	0.57	0.43	0.34
	VC	50	0.28	20.8	16.6	13.9	10.4	8.3	6.9	5.5	4.2	0.95	0.64	0.48	0.38
	VC	60	0.31	23.0	18.4	15.3	11.5	9.2	7.7	6.1	4.6	1.06	0.70	0.53	0.42
	VC	70	0.33	24.5	19.6	16.3	12.3	9.8	8.2	6.5	4.9	1.13	0.75	0.56	0.45
	VC	80	0.35	26.0	20.8	17.3	13.0	10.4	8.7	6.9	5.2	1.19	0.80	0.60	0.48
	VC	90	0.38	28.2	22.6	18.8	14.1	11.3	9.4	7.5	5.6	1.30	0.86	0.65	0.52
	VC	100	0.40	29.7	23.8	19.8	14.9	11.9	9.9	7.9	1.36	0.91	0.68	0.55	
03	XC	40	0.30	22.3	17.8	14.9	11.1	8.9	7.4	5.9	4.5	1.02	0.68	0.51	0.41
	VC	50	0.34	25.2	20.2	16.8	12.6	10.1	8.4	6.7	5.0	1.16	0.77	0.58	0.46
	VC	60	0.37	27.5	22.0	18.3	13.7	11.0	9.2	7.3	5.5	1.26	0.84	0.63	0.50
	VC	70	0.40	29.7	23.8	19.8	14.9	11.9	9.9	7.9	5.9	1.36	0.91	0.68	0.55
	VC	80	0.42	31.2	24.9	20.8	15.6	12.5	10.4	8.3	6.2	1.43	0.95	0.72	0.57
	VC	90	0.45	33.4	26.7	22.3	16.7	13.4	11.1	8.9	6.7	1.53	1.02	0.77	0.61
	VC	100	0.47	34.9	27.9	23.3	17.4	14.0	11.6	9.3	1.60	1.07	0.80	0.64	
04	XC	40	0.40	29.7	23.8	19.8	14.9	11.9	9.9	7.9	5.9	1.36	0.91	0.68	0.55
	VC	50	0.45	33.4	26.7	22.3	16.7	13.4	11.1	8.9	6.7	1.53	1.02	0.77	0.61
	VC	60	0.49	36.4	29.1	24.3	18.2	14.6	12.1	9.7	7.3	1.67	1.11	0.84	0.67
	VC	70	0.53	39.4	31.5	26.2	19.7	15.7	13.1	10.5	7.9	1.81	1.20	0.90	0.72
	VC	80	0.57	42.3	33.9	28.2	21.2	16.9	14.1	11.3	8.5	1.94	1.30	0.97	0.78
	VC	90	0.60	44.6	35.6	29.7	22.3	17.8	14.9	11.9	8.9	2.05	1.36	1.02	0.82
	VC	100	0.63	46.8	37.4	31.2	23.4	18.7	15.6	12.5	9.4	2.15	1.43	1.07	0.86

Features	
Common Use	Weeds
Pattern	Off-Center Fan
Technology	Air Induction
Material	Ceramic
Spray Angle	80°
Pressure Range	40-100 PSI (3-7 BAR)
Configuration	Nozzle
Part Numbers	
Nozzles 80°	Caps (25 Pack)
AVI-OC-80015	CAP01-015
AVI-OC-8002	CAP01-02
AVI-OC-80025	CAP01-025
AVI-OC-8003	CAP01-03
AVI-OC-8004	CAP01-04

## Metric Units

Nozzle Size	Droplet Size 80°	Pressure (Bar)	Flow Rate (LPM)	Liters/Hectare 50cm Spacing km/h															
				4	5	6	7	8	9	10	12	14	16	18	20				
015	VC	3	0.15	180	144	120	103	90	80	72	60	51	45	40	36				
	VC	4	0.05	207	166	138	118	104	92	83	69	59	52	46	41				
	VC	5	0.05	231	185	154	132	116	103	92	77	66	58	51	46				
02	XC	3	0.20	240	192	160	137	120	107	96	80	69	60	53	48				
	VC	4	0.06	273	218	182	156	137	121	109	91	78	68	61	55				
	VC	5	0.07	309	247	206	177	155	137	124	103	88	77	9	62				
025	XC	3	0.25	300	240	200	171	150	133	120	100	86	75	67	60				
	VC	4	0.08	345	276	230	197	173	153	138	115	99	86	77	69				
	VC	5	0.09	387	310	258	221	194	172	155	129	111	97	86	77				
03	XC	3	0.30	360	288	240	206	180	160	144	120	103	90	80	92				
	VC	4	0.09	417	334	278	238	209	185	167	139	119	104	93	83				
	VC	5	0.11	465	372	310	266	233	207	186	155	133	116	103	93				
04	XC	3	0.40	480	384	320	274	240	213	192	160	137	120	107	96				
	VC	4	0.13	555	444	370	317	278	247	222	185	159	139	123	111				
	VC	5	0.14	621	497	414	355	311	276	248	207	177	155	138	124				

Albuz® is a registered trademark of SAINT-GOBAIN SOLCERA, SAINT GOBAIN CERAMIQUES AVANCEES DESMARQUEST, CERAMIQUES TECHNIQUES DESMARQUEST, and SOCIETE DESMARQUEST ET CEC.  
 Hypro® is a registered trademark of Pentair.



# Boomless Flat Fan Nozzles - XT-Boom X Tender



The XT introduces boomless spray technology, enabling spray to be targeted into places that conventional booms and other nozzles cannot reach. XT delivers a uniform spray pattern over a distance of up to 16 feet (4.9 m). Ideal for weed control in forests and pastureland.

- Ideal for applications where a conventional boom cannot be used due to obstacles
- Common uses include orchard, vineyard, forestry, pasture, turf and golf course spraying, as well as maintaining rights-of-way and fence rows
- Excellent low-drift option while extending spray reach
- Large droplet size reduces spray drift and promotes spray penetration
- Maintains a consistent spray swath over a pressure range of 30-60 psi (2-5 bar)
- Standard models with precision-molded polyacetal nozzle and threaded stainless steel body provide excellent durability and low maintenance

## US Units

Nozzle Size (MNPT)	Pressure (PSI)	Flow Rate (GPM)	Gallons per Acre at swath shown MPH								GAL/1000ft <sup>2</sup>				Swath (Ft) at 40 PSI 48 in high
			4	5	6	8	10	12	15	20	2	3	4	5	
10 (1/4")	30	0.9	8.9	7.1	5.9	4.5	3.6	3.0	2.4	1.8	0.41	0.27	0.20	0.16	13
	40	1.0	9.9	7.9	6.6	5.0	4.0	3.3	2.6	2.0	0.45	0.30	0.23	0.18	
	50	1.1	10.9	8.7	7.3	5.4	4.4	3.6	2.9	2.2	0.50	0.33	0.25	0.20	
	60	1.2	11.9	9.5	7.9	5.9	4.8	4.0	3.2	2.4	0.55	0.36	0.27	0.22	
15 (1/4")	30	1.3	10.9	8.7	7.3	5.4	4.4	3.6	2.9	2.2	0.53	0.35	0.26	0.21	14
	40	1.5	12.5	10.0	8.3	6.3	5.0	4.2	3.4	2.5	0.61	0.41	0.30	0.24	
	50	1.7	13.7	11.0	9.2	6.9	5.5	4.6	3.7	2.8	0.67	0.45	0.33	0.27	
	60	1.8	15.0	12.0	10.0	7.5	6.0	5.0	4.0	3.0	0.73	0.49	0.37	0.29	
20 (1/4")	30	1.7	13.6	10.9	9.0	6.8	5.4	4.5	3.6	2.7	0.62	0.42	0.31	0.25	15
	40	2.0	16.0	12.8	10.6	8.0	6.4	5.3	4.3	3.2	0.73	0.49	0.37	0.29	
	50	2.2	17.6	14.1	11.7	8.8	7.0	5.9	4.7	3.5	0.81	0.54	0.40	0.32	
	60	2.4	19.2	15.3	12.8	9.6	7.7	6.4	5.1	3.8	0.88	0.59	0.44	0.35	
24 (1/4")	30	2.1	16.2	13.0	10.8	8.1	6.5	5.4	4.3	3.2	0.75	0.50	0.37	0.30	16
	40	2.4	18.6	14.9	12.4	9.3	7.4	6.2	5.0	3.7	0.85	0.57	0.43	0.34	
	50	2.7	20.9	16.7	13.9	10.4	8.4	7.0	5.6	4.2	0.96	0.64	0.48	0.38	
	60	2.9	22.4	17.9	15.0	11.2	9.0	7.5	6.0	4.5	1.03	0.69	0.51	0.41	
43 (3/8")	30	3.7	31.6	25.3	21.1	15.8	12.6	10.5	8.4	6.3	1.45	0.97	0.72	0.58	14
	40	4.3	36.7	29.4	24.5	18.3	14.7	12.2	9.8	7.3	1.68	1.12	0.84	0.67	
	50	4.8	41.0	32.8	27.3	20.5	16.4	13.7	10.9	8.2	1.88	1.25	0.94	0.75	
	60	5.3	45.2	36.2	30.2	22.6	18.1	15.1	12.1	9.0	2.08	1.38	1.04	0.83	
80 (1/2")	30	6.9	68.3	54.6	45.5	34.2	27.3	22.8	18.2	13.7	3.14	2.09	1.57	1.25	13
	40	8.0	79.2	63.4	52.8	39.6	31.7	26.4	21.1	15.8	3.64	2.42	1.82	1.45	
	50	8.9	88.1	70.5	58.7	44.1	35.2	29.4	23.5	17.6	4.04	2.70	2.02	1.62	
	60	9.8	97.0	77.6	64.7	48.5	38.8	32.3	25.9	19.4	4.45	2.97	2.23	1.78	
167 (3/4")	30	14.5	128	103	85.4	64.1	51.3	42.7	34.2	25.6	5.88	3.92	2.94	2.35	15
	40	16.7	148	118	98.4	73.8	59.0	49.2	39.4	29.5	6.78	4.52	3.39	2.71	
	50	18.7	165	132	110	82.6	66.1	55.1	44.1	33.1	7.59	5.06	3.79	3.03	
	60	20.5	181	145	121	90.6	72.5	60.4	48.3	36.2	8.32	5.54	4.16	3.33	
215 (3/4")	30	18.6	144	115	95.9	71.9	57.5	48.0	38.4	28.8	6.60	4.40	3.30	2.64	16
	40	21.5	166	133	111	83.1	66.5	55.4	44.3	33.3	7.63	5.09	3.82	3.05	
	50	24.0	186	149	124	92.8	74.3	61.9	49.5	37.1	8.52	5.68	4.26	3.41	
	60	26.3	203	163	136	102	81.4	67.8	54.2	40.7	9.34	6.22	4.67	3.73	

## Typical Spray Pattern Produced by XT Series

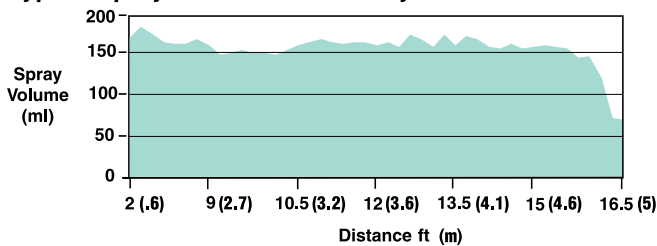

## Common Uses of the Boom X Tender Spray Nozzles

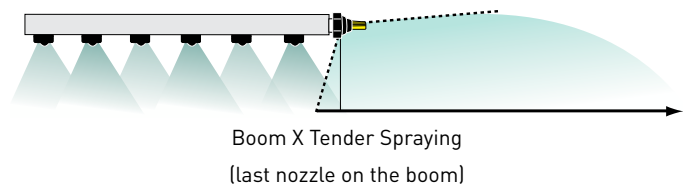

## Adjustable Swath Width

Swath width can be increased or decreased by adjusting the angle of the nozzle +/- 18°.

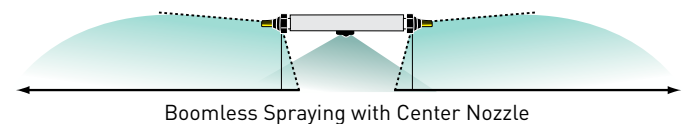
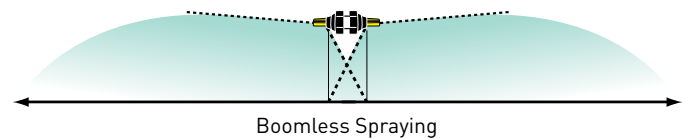
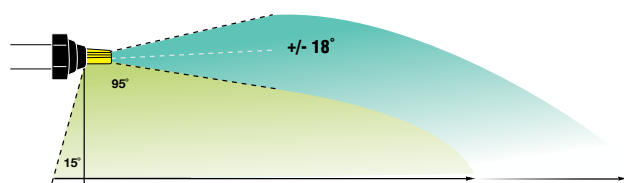



Boom X Tender nozzles are ideal for boomless spraying or as the last nozzle on a boom.



Hypro's Boom X Tender nozzles provide excellent coverage throughout the swath width for superior results.



Gasket, insert and o-ring kits available to rebuild MNPT versions.

### Metric Units

Nozzle Size (MNPT)	Pressure (BAR)	Flow Rate (LPM)	Application Rate L/ha - at swath shown KM/H											Swath Width (M) @ 2.76 BAR 1.22 meters high
			4	5	6	7	8	10	12	14	16	18	20	
10 (1/4 inch)	2	3.2	124	99	83	71	62	50	41	35	31	28	25	3.9
	3	3.9	152	121	101	87	76	61	51	43	38	34	30	
	4	4.6	175	140	117	100	88	70	58	50	44	39	35	
15 (1/4 inch)	2	4.6	162	129	108	92	81	65	54	46	40	36	32	4.3
	3	5.7	198	159	132	113	99	79	66	57	50	44	40	
	4	6.6	229	183	153	131	114	92	76	65	57	51	46	
20 (1/4 inch)	2	6.4	201	161	134	115	101	81	67	58	50	45	40	4.8
	3	7.9	247	197	165	141	123	99	82	71	62	55	49	
	4	9.1	285	228	190	163	142	114	95	81	71	63	57	
24 (1/4 inch)	2	7.7	237	189	158	135	118	95	79	68	59	53	47	4.9
	3	9.5	290	232	193	166	145	116	97	83	73	64	58	
	4	10.9	335	268	223	191	167	134	112	96	84	74	67	
43 (3/8 inch)	2	13.9	473	378	315	270	236	189	158	135	118	105	95	4.4
	3	17	579	463	386	331	289	232	193	165	145	129	116	
	4	19.6	668	535	446	382	334	267	223	191	167	149	134	
80 (1/2 inch)	2	25.8	992	793	661	567	496	397	331	283	248	220	198	3.9
	3	31.6	1215	972	810	694	607	486	405	347	304	270	243	
	4	36.5	1403	1122	935	802	701	561	468	401	351	312	281	
167 (3/4 inch)	2	53.8	1878	1502	1252	1073	939	751	626	537	469	417	376	4.3
	3	65.9	2300	1840	1533	1314	1150	920	767	657	575	511	460	
	4	76.1	2656	2125	1771	1518	1328	1062	885	759	664	590	531	
215 (3/4 inch)	2	69.3	2122	1697	1414	1212	1061	849	707	606	530	471	424	4.9
	3	84.9	2598	2079	1732	1485	1299	1039	866	742	650	577	520	
	4	98	3000	2400	2000	1715	1500	1200	1000	857	750	667	600	

Swath widths and application rates in charts are based on height of 48 inches (1.2 metres), a different height will give different swath widths

$$\text{GPM} = \frac{\text{GPA} \times \text{MPH} \times \text{swath width (in)}}{5,940}$$

$$\text{GPM} = \frac{\text{GPA} \times 5,940}{\text{MPH} \times \text{swath width (in)}}$$

$$\text{LPM} = \frac{\text{L/ha} \times \text{Kmph} \times \text{swath width (m)}}{600}$$

$$\text{L/ha} = \frac{\text{LPM} \times 600}{\text{Kmph} \times \text{swath width (m)}}$$

Features		
Common Use	Weeds	
Pattern	Boomless Fan	
Technology	Pre-Orifice	
Material	Stainless or Polyacetal	
Spray Angle	105°	
Pressure Range	30-60 PSI (2-5 BAR)	
Configuration	MNPT & FastCap	
Part Numbers		
FastCaps	MNPT (Thread)	Parts Kits for MNPT version
FC-XT010	XT010 (1/4")	XT010-GIOKIT
FC-XT015	-	-
FC-XT020	XT020 (1/4")	XT020-GIOKIT
FC-XT024	XT024 (1/4")	XT024-GIOKIT
FC-XT043	XT043 (3/8")	XT043-GIOKIT
-	XT080 (1/2")	XT080-GIOKIT
-	XT167 (3/4")	XT167-GIOKIT
-	XT215 (3/4")	XT215-GIOKIT
Replacement FastCap Seal		
22W11MF64		



Model	Description
9950-0033	Boom X Tender Tee/Swivel Kit for use with 1/4" NPT or Fastcap XT Nozzles



# Acid-Resistant Lo-Drift 110°



The Lo-Drift's two-part construction includes a pre-orifice, which reduces the number of drift prone droplets and makes it ideal for broadcast application of acidic defoliants.

- Acid-resistant material construction
- Significantly reduces spray drift, widening the operational window
- Balanced droplet size for effective, on-target spray

## US Units

Nozzle Size	Droplet Size	Pressure (PSI)	Flow Rate (GPM)	Gallons per Acre 20 inch nozzle spacing MPH								GAL/1000 <sup>ft</sup> <sup>3</sup> 20 inch nozzle spacing			
				4	5	6	8	10	12	15	20	4	5	6	7
03	C	15	0.18	13.4	10.7	8.9	6.7	5.3	4.5	3.6	2.7	0.61	0.41	0.31	0.25
	C	20	0.21	15.6	12.5	10.4	7.8	6.2	5.2	4.2	3.1	0.72	0.48	0.36	0.29
	C	30	0.26	19.3	15.4	12.9	9.7	7.7	6.4	5.1	3.9	0.89	0.59	0.44	0.35
	M	40	0.30	22.3	17.8	14.9	11.1	8.9	7.4	5.9	4.5	1.02	0.68	0.51	0.41
	M	50	0.34	25.2	20.2	16.8	12.6	10.1	8.4	6.7	5.0	1.16	0.77	0.58	0.46
	M	60	0.37	27.5	22.0	18.3	13.7	11.0	9.2	7.3	5.5	1.26	0.84	0.63	0.50
04	C	15	0.24	17.8	14.3	11.9	8.9	7.1	5.9	4.8	3.6	0.82	0.55	0.41	0.33
	C	20	0.28	20.8	16.6	13.9	10.4	8.3	6.9	5.5	4.2	0.95	0.64	0.48	0.38
	C	30	0.35	26.0	20.8	17.3	13.0	10.4	8.7	6.9	5.2	1.19	0.80	0.60	0.48
	M	40	0.40	29.7	23.8	19.8	14.9	11.9	9.9	7.9	5.9	1.36	0.91	0.68	0.55
	M	50	0.45	33.4	26.7	22.3	16.7	13.4	11.1	8.9	6.7	1.53	1.02	0.77	0.61
	M	60	0.49	36.4	29.1	24.3	18.2	14.6	12.1	9.7	7.3	1.67	1.11	0.84	0.67
05	C	15	0.31	23.0	18.4	15.3	11.5	9.2	7.7	6.1	4.6	1.06	0.70	0.53	0.42
	C	20	0.35	26.0	20.8	17.3	13.0	10.4	8.7	6.9	5.2	1.19	0.80	0.60	0.48
	C	30	0.43	31.9	25.5	21.3	16.0	12.8	10.6	8.5	6.4	1.47	0.98	0.73	0.59
	C	40	0.50	37.1	29.7	24.8	18.6	14.9	12.4	9.9	7.4	1.71	1.14	0.85	0.68
	M	50	0.56	41.6	33.3	27.7	20.8	16.6	13.9	11.1	8.3	1.91	1.27	0.95	0.76
	M	60	0.61	45.3	36.2	30.2	22.6	18.1	15.1	12.1	9.1	2.08	1.39	1.04	0.83
06	VC	15	0.37	27.5	22.0	18.3	13.7	11.0	9.2	7.3	5.5	1.26	0.84	0.63	0.50
	C	20	0.42	31.2	24.9	20.8	15.6	12.5	10.4	8.3	6.2	1.43	0.95	0.72	0.57
	C	30	0.52	38.6	30.9	25.7	19.3	15.4	12.9	10.3	7.7	1.77	1.18	0.89	0.71
	C	40	0.60	44.6	35.6	29.7	22.3	17.8	14.9	11.9	8.9	2.05	1.36	1.02	0.82
	C	50	0.67	49.7	39.8	33.2	24.9	19.9	16.6	13.3	9.9	2.28	1.52	1.14	0.91
	C	60	0.73	54.2	43.4	36.1	27.1	21.7	18.1	14.5	10.8	2.49	1.66	1.24	1.00
		70	0.79	58.7	46.9	39.1	29.3	23.5	19.6	15.6	2.69	1.80	1.35	1.08	

Droplet size based on ASABE S572.1 standard.

Features	
Common Use	Acid Defoliants
Pattern	Tapered Flat Fan
Technology	Pre-Orifice
Material	PVDF
Spray Angle	110°
Pressure Range	15-70 PSI (1-5 BAR)
Configuration	Nozzles
Part Numbers	
Nozzles 110°	
	90LD03F110
	90LD04F110
	90LD05F110
	90LD06F110

## Metric Units

Nozzle Size	Droplet Size	Pressure (BAR)	Flow Rate (LPM)	Application Rate L/Ha - 50 cm Spacing KM/H							
				7	8	10	12	15	20	25	30
03	C	1	0.69	118	104	83	69	55	41	33	28
	C	1.5	0.85	146	128	102	85	68	51	41	34
	C	2	0.98	168	147	118	98	78	59	47	39
	M	3	1.20	206	180	144	120	96	72	58	48
	M	4	1.39	238	209	167	139	111	83	67	56
04	C	1	0.92	158	138	110	92	74	55	44	37
	C	1.5	1.13	194	170	136	113	90	68	54	45
	C	2	1.31	225	197	157	131	105	79	63	52
	M	3	1.60	274	240	192	160	128	96	77	64
	M	4	1.85	317	278	222	185	148	111	89	74
05	C	1	1.15	197	173	138	115	92	69	55	46
	C	1.5	1.41	242	212	169	141	113	85	68	56
	C	2	1.63	279	245	196	163	130	98	78	65
	M	3	2.00	343	300	240	200	160	120	96	80
	M	4	2.31	396	347	277	231	185	139	111	92
06	VC	1	1.39	238	209	167	139	111	83	67	56
	C	1.5	1.70	291	255	204	170	136	102	82	68
	C	2	1.96	336	294	235	196	157	118	94	78
	C	3	2.40	411	360	288	240	192	144	115	96
	C	4	2.77	475	416	332	277	222	166	133	111
		5	3.10	531	465	372	310	248	186	149	124

Droplet size based on ASABE S572.1 standard.



# Sudden Impact

## High Impact Car Wash Nozzle

**25% WATER SAVINGS!  
5X'S THE LIFE!**



Sample Part Number: **TUR324B-2.0**

Breakdown:

**TUR 324 B - 2.0**  
series material size  
brass 2.0

- Provides a high impact, controlled rotation 0° water stream with much greater impact and cleaning efficiency than other nozzles which reduces wash time & increases thru-put
- Lasts up to five times longer than other rotating nozzles on the market, reducing operating costs over the life of the car wash
- Improved cleaning efficiency over other rotating nozzles reduces water consumption by up to 25%
- Tungsten carbide seat and nozzle provide unmatched wear and shatter resistance over ceramic material commonly utilized in other nozzles
- High strength, forged housing available in economical brass or corrosion-resistant 304 stainless steel
- Elastomer cover protects vehicles and nozzles
- Precision-machined bearing in rotor offers very high wear resistance and optimal impact
- Available with 24° pattern for maximum impact or 30° pattern for extra coverage
- BSP-style connection available in 24° brass (sizes 2.0, 3.5, 4.5) for use in Mark VII® washes

### Nozzle Specifications

Series	Pressure*	Ideal Impact Distance	Material	Angle	Temperature
TUR324B-x.x	1750 PSI (120 bar)	20"-30" (51-76cm)	Brass	24°	180° F (82° C)
TUR324B-x.x-BSP	1750 PSI (120 bar)	20"-30" (51-76cm)	Brass	24°	180° F (82° C)
TUR324S-x.x	3000 PSI (207 bar)	20"-30" (51-76cm)	Stainless	24°	180° F (82° C)
TUR330B-x.x	1300 PSI (90 bar)	15"-25" (38-63cm)	Brass	30°	180° F (82° C)
TUR330S-x.x	3000 PSI (207 bar)	15"-25" (38-63cm)	Stainless	30°	180° F (82° C)

\*See rate chart below for specific information

### Dimensional Chart

Series	A (in)	A (mm)	B (in)	B (mm)
324	3.05	77.5	1.49	37.8
330	2.96	75.6	1.69	42.9

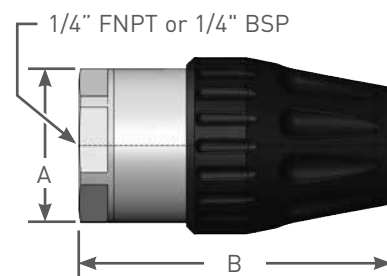

Spray Nozzle Size	Flow Rate (US GPM)											Flow Rate (L/min)										
	Pressure (PSI)											Pressure (BAR)										
	800	900	1000	1100	1200	1500	2000	2250	2500	2750	3000	50	60	70	80	90	100	120	140	160	180	200
2.0	0.89	0.95	1.00	1.05	1.10	1.22	1.41	1.50	1.58	1.66	1.73	3.21	3.51	3.80	4.06	4.30	4.54	4.97	5.37	5.74	6.09	6.42
3.0	1.34	1.42	1.50	1.57	1.64	1.84	2.12	2.25	2.37	2.49	2.60	4.83	5.29	5.71	6.11	6.48	6.83	7.48	8.08	8.64	9.16	9.66
3.5	1.57	1.66	1.75	1.84	1.92	2.14	2.47	2.63	2.77	2.90	3.03	5.66	6.20	6.70	7.16	7.59	8.00	8.77	9.47	10.10	10.70	11.30
4.0	1.79	1.90	2.00	2.10	2.19	2.45	2.83	3.00	3.16	3.32	3.46	6.45	7.07	7.63	8.16	8.66	9.12	9.99	10.80	11.50	12.20	12.90
4.5	2.01	2.13	2.25	2.36	2.46	2.76	3.18	3.38	3.56	3.73	3.90	7.24	7.94	8.57	9.16	9.72	10.20	11.20	12.10	12.90	13.70	14.40
5.0	2.24	2.37	2.50	2.62	2.74	3.06	3.54	3.75	3.95	4.15	4.33	8.07	8.84	9.55	10.20	10.80	11.40	12.50	13.50	14.40	15.30	16.10
5.5	2.46	2.61	2.75	2.88	3.01	3.37	3.89	4.13	4.35	4.56	4.76	8.87	9.71	10.40	11.20	11.80	12.50	13.70	14.80	15.80	16.80	17.70
6.0	2.68	2.85	3.00	3.15	3.29	3.67	4.24	4.50	4.74	4.97	5.20	9.66	10.50	11.40	12.20	12.90	13.60	14.90	16.10	17.20	18.30	19.30

### Sample Part Number

TUR	3	24	B	-	2.0
Model	Size	Angle	Material	Dash	Nozzle Number
Turbo (NPT)	3	24° or 30°	"B" Brass or "S" Stainless	-	2.0, 3.0, 3.5, 4.0, 4.5, 5.0, 5.5, 6.0
Turbo (BSP) for Mark VII® Washes*	3	24°	"B" Brass	-	2.0, 3.5, 4.5

Note: BSP Models: Add suffix "BSP" -example TUR324B-2.0BSP

# UAS - Ceramic Nozzle

## High Impact Car Wash Nozzle

**10X'S THE LIFE  
OVER  
STAINLESS!**



Sample Part Number: UAS1/4-25-04

Breakdown:

<b>UAS</b>	<b>1/4</b>	<b>-</b>	<b>25</b>	<b>-</b>	<b>04</b>
model	connection		spray angle		size
UAS	1/4" NPT		25°		04

- Ceramic inserts provide up to 10 times the life of hardened stainless steel, maximizing your return on investment and decreasing downtime for nozzle replacement
- Extra long-life ceramic orifice is nearly diamond-hard to resist wear
- Molded ceramic virtually eliminates chemical and mineral buildup in the orifice area
- Wear characteristics make the UAS nozzle ideal for reclaim systems
- The U-shaped outlet provides a high-impact spray without additional inserts
- Wedge-shaped orifice insert seats tightly as spray pressures increase
- Precision-machined stainless steel carriers resist corrosion and damage
- High quality components easily withstand wash pressures of 800 to 5000 psi (55-345 BAR)
- 1/4" NPT connection fits all common applications
- Permanent laser-etched part number markings ease identification
- Comes in spray angles of 0°, 15°, 25°, 40°

Spray Nozzle Size	Flow Rate (US GPM)												
	Pressure (PSI)												
	800	900	1000	1200	1500	1800	2000	2500	3000	3500	4000	4500	5000
015	0.67	0.71	0.75	0.82	0.92	1.01	1.06	1.19	1.30	1.40	1.50	1.59	1.68
02	0.89	0.95	1.00	1.10	1.22	1.34	1.41	1.58	1.73	1.87	2.00	2.12	2.24
025	1.12	1.19	1.25	1.37	1.53	1.68	1.77	1.98	2.17	2.34	2.50	2.65	2.80
03	1.34	1.42	1.50	1.64	1.84	2.01	2.12	2.37	2.60	2.81	3.00	3.18	3.35
035	1.57	1.66	1.75	1.92	2.14	2.35	2.47	2.77	3.03	3.27	3.50	3.71	3.91
04	1.79	1.90	2.00	2.19	2.45	2.68	2.83	3.16	3.46	3.74	4.00	4.24	4.47
045	2.01	2.13	2.25	2.46	2.76	3.02	3.18	3.56	3.90	4.21	4.50	4.77	5.03
05	2.24	2.37	2.50	2.74	3.06	3.35	3.54	3.95	4.33	4.68	5.00	5.30	5.59
055	2.46	2.61	2.75	3.01	3.37	3.69	3.89	4.35	4.76	5.14	5.50	5.83	6.15
06	2.68	2.85	3.00	3.29	3.67	4.02	4.24	4.74	5.20	5.61	6.00	6.36	6.71
065	2.91	3.08	3.25	3.56	3.98	4.36	4.60	5.14	5.63	6.08	6.50	6.89	7.27
07	3.13	3.32	3.50	3.83	4.29	4.70	4.95	5.53	6.06	6.55	7.00	7.42	7.83
08	3.58	3.79	4.00	4.38	4.90	5.37	5.66	6.32	6.93	7.48	8.00	8.49	8.94
09	4.02	4.27	4.50	4.93	5.51	6.04	6.36	7.12	7.79	8.42	9.00	9.55	10.06
10	4.47	4.74	5.00	5.48	6.12	6.71	7.07	7.91	8.66	9.35	10.00	10.61	11.18
12	5.37	5.69	6.00	6.57	7.35	8.05	8.49	9.49	10.39	11.22	12.00	12.73	13.42

# HP-High Pressure Nozzle

## Hardened Stainless Steel



- Achieves up to 16%\* greater impact than competitive high pressure nozzles, making them the best value on the market today
- Hardened 416 stainless steel, the industry standard for long-life
- Reliable performance in high pressure applications up to 4000 psi (276 BAR)
- High impact spray in a tightly formed fan pattern
- Consistent, even distribution provides uniform cleaning without overlapping
- Protected outlet design guards the orifice during installation and use
- Versatile 1/4" and 1/8" NPT connections suit a variety of applications
- Comes in spray angles of 0°, 5°, 15°, 25°, 40°
- Improved marking for easy identification and replacement

\*Commissioned with an independent tester

### Available Spray Angles\*\*

In Stock    Available    Contact Factory

Sample Part Number: HP1/4-2504

Breakdown:

**HP 1/4 - 25 - 04**  
model connection spray angle size  
 HP 1/4" NPT 25° 04

Degree	Size														
	02	03	035	04	045	05	055	06	065	07	075	08	085	09	
1/8" NPT	0°	X	X	X	X	X	X	X	X	X	X	X	X		
	5°	X			X	X	X	X							
	15°	X	X	X	X	X	X	X	X	X	X	X	X	X	
	25°	X	X	X	X	X	X	X	X	X	X	X	X	X	
1/4" NPT	0°	X	X	X	X	X	X	X	X	X	X	X	X		
	5°				X	X	X					X		X	
	15°	X	X	X	X	X	X	X	X	X	X	X	X		
	25°	X	X	X	X	X	X	X	X	X	X	X	X		
	40°	X	X	X	X	X	X	X	X	X	X	X	X		

\*\*For additional sizes, please contact Technical/Applications at 1-800-445-8360

### US Units

Spray Nozzle Size	1/8" NPT	1/4" NPT	Flow Rate (US GPM)													
			Pressure (PSI)													
			300	400	500	600	700	800	1000	1250	1500	2000	2500	3000	3500	4000
02	X	X	0.55	0.63	0.71	0.77	0.84	0.89	1.00	1.12	1.22	1.41	1.58	1.73	1.87	2.00
03	X	X	0.82	0.95	1.60	1.16	1.25	1.34	1.50	1.68	1.84	2.12	2.37	2.06	2.81	3.00
035	X	X	0.96	1.11	1.24	1.36	1.46	1.57	1.75	1.96	2.14	2.47	2.77	3.03	3.27	3.50
04	X	X	1.10	1.26	1.41	1.55	1.67	1.79	2.00	2.24	2.45	2.83	3.16	3.46	3.74	4.00
045	X	X	1.23	1.42	1.59	1.74	1.88	2.01	2.25	2.52	2.76	3.18	3.56	3.90	4.21	4.50
05	X	X	1.37	1.58	1.77	1.94	2.09	2.24	2.50	2.80	3.06	3.54	3.95	4.33	4.68	5.00
055	X	X	1.51	1.74	1.94	2.13	2.30	2.46	2.75	3.07	3.37	3.89	4.35	4.76	5.14	5.50
06	X	X	1.64	1.90	2.12	2.32	2.51	2.68	3.00	3.35	3.67	4.24	4.74	5.20	5.61	6.00
065	X	X	1.78	2.06	2.30	2.52	2.72	2.91	3.25	3.68	3.98	4.60	5.14	5.63	6.08	6.50
07	X	X	1.92	2.21	2.47	2.71	2.93	3.13	3.50	3.91	4.29	4.95	5.53	6.06	6.55	7.00
075	X	X	2.05	2.37	2.65	2.90	3.14	3.35	3.75	4.19	4.59	5.30	5.93	6.50	7.02	7.50
08	X	X	2.19	2.53	2.83	3.10	3.35	3.58	4.00	4.47	4.90	5.66	6.32	6.93	7.48	8.00
085	X		2.33	2.69	3.01	3.29	3.56	3.80	4.25	4.75	5.21	6.01	6.72	7.36	7.95	8.50
09		X	2.46	2.85	3.18	3.49	3.76	4.02	4.50	5.03	5.51	6.36	7.12	7.79	8.42	9.00

### Metric Units

Spray Nozzle Size	1/8" NPT	1/4" NPT	Flow Rate (L/min)													
			Pressure (BAR)													
			15	20	30	40	50	60	70	80	100	150	200			
02	X	X	1.77	2.04	2.50	2.88	3.22	3.53	3.81	4.08	4.56	5.58	6.45			
03	X	X	2.65	3.06	3.75	4.32	4.84	5.30	5.72	6.12	6.84	8.38	9.67			
035	X	X	3.09	3.57	4.37	5.05	5.64	6.18	6.67	7.14	7.98	9.77	11.20			
04	X	X	3.53	4.08	4.99	5.77	6.45	7.06	7.63	8.16	9.12	11.10	12.80			
045	X	X	3.97	4.59	5.62	6.49	7.25	7.95	8.58	9.17	10.20	12.50	14.50			
05	X	X	4.41	5.10	6.24	7.21	8.06	8.83	9.54	10.10	11.40	13.90	16.10			
055	X	X	4.86	5.61	6.87	7.93	8.86	9.71	10.40	11.20	12.50	15.30	17.70			
06	X	X	5.30	6.12	7.49	8.65	9.67	10.50	11.40	12.20	13.60	16.70	19.30			
065	X	X	5.74	6.63	8.12	9.37	10.40	11.40	12.40	13.20	14.80	18.10	20.90			
07	X	X	6.18	7.14	8.74	10.00	11.20	12.30	13.30	14.20	15.90	19.50	22.50			
075	X	X	6.62	7.65	9.36	10.80	12.00	13.20	14.30	15.20	17.10	20.90	24.10			
08	X	X	7.06	8.16	9.99	11.50	12.80	14.10	15.20	16.30	18.20	22.30	25.70			
085	X		7.50	8.66	10.60	12.20	13.70	15.00	16.20	17.30	19.30	23.70	27.40			
09		X	7.95	9.17	11.20	12.90	14.50	15.80	17.10	18.30	20.50	25.10	29.00			

# Car Wash Nozzle Kits



Save time by not having to order each replacement tip individually, just order one part number for your model of car wash to receive the entire replacement kit. When you install Hypro spray tips, your wash will be brought back to life with increased performance, making your car wash better than new!

## Washworld High Velocity® Arch & Under Carriage Kits

Car Wash Kits	Kit Description	Quantity	Contains:
HPWWHV	Wash World High Velocity Arch Nozzles, Hardened Stainless Steel	1	HP1/4-4003
		1	HP1/4-2503
		14	HP1/4-1504
		2	HP1/4-1505
		1	HP1/4-4004
		1	HP1/4-4003
HPWWHVUC	Wash World High Velocity Under-Carriage Nozzles, Hardened Stainless Steel	7	HP1/4-1508
		4	HP1/4-4003
UASWWHV	Wash World High Velocity Arch Nozzles, Premium Ceramic Orifice	1	UAS1/4-40-03
		1	UAS1/4-25-03
		14	UAS1/4-15-04
		2	UAS1/4-15-05
		1	UAS1/4-40-04
UASWWHVUC	Wash World High Velocity Under-Carriage Nozzles, Premium Ceramic Orifice	7	UAS1/4-15-08
		4	UAS1/4-40-03

## PDQ® Laser 4000 Kits

Car Wash Kits	Kit Description	Quantity	Contains:
UASPDQ4000	PDQ Laser 4000 Stainless/Ceramic Nozzles	11	UAS1/4-15-04
		5	UAS1/4-15-05
		1	UAS1/4-25-03
		1	UAS1/4-40-03
HPPDQ4000	PDQ Laser 4000 Arch 1/4" Hardened Stainless Steel Nozzles	11	HP1/4-1504
		5	HP1/4-1505
		1	HP1/4-2503
		1	HP1/4-4003

## D&S 5000™, Super 5000 & Quicksilver, Arch & Wheel Blaster Kits

Car Wash Kits	Kit Description	Quantity	Contains:
HPDS5000	D&S 5000, Super 5000, Quicksilver 38 GPM Arch Nozzles	4	HP1/4-0508
		4	HP1/4-0509
		4	HP1/4-1502
		4	HP1/4-2504
		6	HP1/4-2507
		6	HP1/4-4006
HPDSQ20WB	D&S Quicksilver Wheel Blaster Option Nozzles	4	HP1/8-00065
		4	HP1/8-0504

# FP-FulcoJet™ Full Cone Nozzle



- Precision-molded orifice provides accurate and consistent full cone spray pattern
- Widely used 1/8" and 1/4" NPT or 1/8" and 1/4" BSP connections
- Available in a variety of standard flow and cone angle options to fit application requirements
- Color coded by flow rate to simplify nozzle installation and replacement
- Excellent wear and chemically-resistant Solef® Polyvinylidene Fluoride (PVDF) polymer
- Ideal for low pressure rinsing, washing, coating, cooling, and additive application

## US Units

Nozzle	Thread	Color	Cone Angle	Flow Rate (Gallons per Minute) of Water at 68°F											
				Pressure (PSI)											
				10	20	30	40	50	60	70	80	90	100	125	150
90A1FP1.0	1/8" NPT	Orange	45°	0.10	0.14	0.16	0.19	0.21	0.22	0.24	0.25	0.27	0.28	0.31	0.34
90A1FP1.5	1/8" NPT	Red	55°	0.15	0.20	0.25	0.28	0.31	0.34	0.36	0.38	0.40	0.42	0.47	0.51
90A1FP2.0	1/8" NPT	Light Blue	60°	0.20	0.27	0.33	0.37	0.41	0.45	0.48	0.51	0.54	0.56	0.62	0.68
90A1FP3.0	1/8" NPT	Lime Green	50°	0.30	0.41	0.49	0.56	0.62	0.67	0.72	0.76	0.81	0.85	0.93	1.01
90A1FP3.5	1/8" NPT	Terracotta	60°	0.35	0.48	0.57	0.65	0.72	0.78	0.84	0.89	0.94	0.99	1.09	1.18
90A1FP5.0	1/8" NPT	Blue	80°	0.50	0.68	0.82	0.93	1.03	1.12	1.20	1.27	1.34	1.41	1.56	1.69
90A2FP6.5	1/4" NPT	Purple	50°	0.65	0.89	1.07	1.21	1.34	1.46	1.56	1.66	1.75	1.83	2.03	2.20
90A2FP10	1/4" NPT	Olive Green	70°	1.00	1.37	1.64	1.87	2.06	2.24	2.40	2.55	2.69	2.82	3.12	3.38

Sample Part Number: 90A1FP2.0

Breakdown:

90	A1	FP	2.0
material	thread	family	nozzle size
90 = PVDF	A1 = 1/8" NPT A2 = 1/4" NPT	FP	see table
	B1 = 1/8" BSP B2 = 1/4" BSP		

## Metric Units

Nozzle	Thread	Color	Cone Angle @ 1 Bar	Flow Rate (L/min) of Water at 20°C							
				Pressure (BAR)							
				0.5	1	2	3	4	5	7	10
90B1FP1	1/8" BSP	Orange	45°	0.32	0.46	0.64	0.79	0.91	1.02	1.21	1.44
90B1FP1.3W	1/8" BSP	Natural	90°	0.42	0.59	0.84	1.03	1.19	1.33	1.57	1.87
90B1FP1.5	1/8" BSP	Red	55°	0.48	0.68	0.97	1.18	1.37	1.53	1.81	2.16
90B1FP2	1/8" BSP	Light Blue	60°	0.64	0.91	1.29	1.58	1.82	2.04	2.41	2.88
90B1FP2W	1/8" BSP	Light Blue	90°	0.64	0.91	1.29	1.58	1.82	2.04	2.41	2.88
90B1FP3	1/8" BSP	Lime Green	50°	0.97	1.37	1.93	2.37	2.74	3.06	3.62	4.32
90B1FP3.5	1/8" BSP	Terracotta	60°	1.13	1.60	2.26	2.76	3.19	3.57	4.22	5.05
90B1FP3.7W	1/8" BSP	Gray	120°	1.19	1.69	2.39	2.92	3.37	3.77	4.46	5.33
90B1FP5	1/8" BSP	Blue	80°	1.61	2.28	3.22	3.95	4.56	5.10	6.03	7.21
90B2FP6.5	1/4" BSP	Purple	50°	2.10	2.96	4.19	5.13	5.93	6.63	7.84	9.37
90B2FP10	1/4" BSP	Olive Green	70°	3.22	4.56	6.45	7.90	9.12	10.1	12.0	14.4

# FanJet™ - Flat Fan PVDF Nozzle



- Most popular selling nozzle for lower pressure car wash applications
- Chemically-resistant Polyvinylidene Fluoride (PVDF) polymer
- Pressures up to 500 PSI
- Available spray angles ranging from 0, 25, 40, 65, 80
- One-piece male 1/4" NPT and 1/4" or 1/8" BSP
- Hex body prevents distortion of the orifice and provides quick and easy installation
- Part number is molded into front of nozzle

## Available Spray Angles\*

Available  Contact Factory

Sample Part Number: 90A2CM04E80

Degree	Size																
	01	015	02	025	03	04	05	06	07	08	10	15	20	30	40	50	
1/4" NPT	0°			X		X	X	X	X	X		X	X	X	X		
	25°	X	X	X		X	X	X	X	X	X	X	X	X	X		
	40°	X	X	X		X	X	X	X	X	X	X	X	X	X	X	
	65°	X	X	X	X	X	X	X	X	X	X	X	X	X	X	X	X
	80°	X	X	X		X	X	X	X		X	X	X	X	X	X	

Breakdown:

<b>90</b>	<b>A2</b>	<b>CM</b>	<b>04</b>	<b>E</b>	<b>80</b>
material	thread	model	nozzle size	pattern even fan	fan angle degrees
90 = PVDF	A1 = 1/8" NPT A1 = 1/8" NPT	NPT			
	B1 = 1/8" BSP B2 = 1/4" BSP				

\*For additional sizes, please contact Technical/Applications at 1-800-445-8360

Spray Nozzle Size	Color	Flow Rate, (US GPM)											
		Pressure (PSI)											
		30	40	50	60	70	80	100	150	200	300	400	500
01	Gray	0.09	0.10	0.11	0.12	0.13	0.14	0.16	0.19	0.22	0.27	0.32	0.35
015	Gray	0.13	0.15	0.17	0.18	0.20	0.21	0.24	0.29	0.34	0.41	0.47	0.53
02	Gray	0.17	0.20	0.22	0.24	0.26	0.28	0.32	0.39	0.45	0.55	0.63	0.71
025	Gray	0.22	0.25	0.28	0.31	0.33	0.35	0.40	0.48	0.56	0.68	0.79	0.88
03	Gray	0.26	0.30	0.34	0.37	0.40	0.42	0.47	0.58	0.67	0.82	0.95	1.06
04	Gray	0.35	0.40	0.45	0.49	0.53	0.57	0.63	0.77	0.89	1.10	1.26	1.41
05	Gray	0.43	0.50	0.56	0.61	0.66	0.71	0.79	0.97	1.12	1.37	1.58	1.77
06	Gray	0.52	0.60	0.67	0.73	0.79	0.85	0.95	1.16	1.34	1.64	1.90	2.12
07	Gray	0.61	0.70	0.78	0.86	0.93	0.99	1.11	1.36	1.57	1.92	2.21	2.47
08	Gray	0.69	0.80	0.89	0.98	1.06	1.13	1.26	1.55	1.79	2.19	2.53	2.83
10	Gray	0.87	1.00	1.12	1.22	1.32	1.41	1.58	1.94	2.24	2.74	3.16	3.54
15	Gray	1.30	1.50	1.68	1.84	1.98	2.12	2.37	2.90	3.35	4.11	4.74	5.30
20	Gray	1.73	2.00	2.24	2.45	2.65	2.83	3.16	3.87	4.47	5.48	6.32	7.07
30	Gray	2.60	3.00	3.35	3.67	3.97	4.24	4.74	5.81	6.71	8.22	9.49	10.61
40	Gray	3.46	4.00	4.47	4.90	5.29	5.66	6.32	7.75	8.94	10.95	12.65	14.14
50	Gray	4.33	5.00	5.59	6.12	6.61	7.07	7.91	9.68	11.18	13.69	15.81	17.68

Spray Nozzle Size	Color	Flow rate, (L/min)						
		Pressure (BAR)						
		0.5	1	2	3	4	5	7
02	Gray	0.33	0.46	0.65	0.80	0.92	1.03	1.22
03	Gray	0.49	0.69	0.98	1.20	1.39	1.55	1.83
04	Gray	0.65	0.92	1.31	1.60	1.85	2.07	2.44
05	Gray	0.82	1.15	1.63	2.00	2.31	2.58	3.06
06	Gray	0.98	1.39	1.96	2.40	2.77	3.10	3.67
08	Gray	1.31	1.85	2.61	3.20	3.70	4.13	4.89
10	Gray	1.63	2.31	3.27	4.00	4.62	5.16	6.11
15	Gray	2.45	3.46	4.90	6.00	6.93	7.75	9.17
20	Gray	3.27	4.62	6.53	8.00	9.24	10.3	12.2
30	Gray	4.90	6.93	9.80	12.0	13.8	15.4	18.3
40	Gray	6.53	9.24	13.0	16.0	18.4	20.6	24.4
50	Gray	8.16	11.5	16.3	20.0	23.0	25.8	30.5

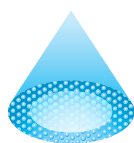

# Misting Nozzles - F, HAF, PF, AFD, AF



The Hypro® range of misting nozzles produce a high percentage of droplets smaller than 50 microns making the sprays suitable for humidification and evaporative cooling. They are chemically resistant to also allow use with pesticides, disinfectants, and odor control agents as well as dust suppression.

- A variety of connection options match most applications
- Corrosion-resistant construction
- Strainers are included on many models to extend service life
- Anti-drip checks are standard in PF and AFD models

## Flanged Nozzles: F-Flat Fan



Color	Spray Angle	US gal/hr @ pressure (PSI)					L/hr @ pressure (bar)					Part Number Nozzle Only
		40	60	75	100	150	3	4	6	8	10	
White	65	2.89	3.54	3.96	4.57	5.60	11,59	13,38	16,39	18,93	21,16	F65-005
Olive Green	80	4.00	4.90	5.48	6.32	7.75	16,04	18,52	22,68	26,19	29,28	F80-0067

## Flanged Nozzles: HAF-Hollow Cone



Color	Spray Angle	US gal/hr @ pressure (PSI)					L/hr @ pressure (bar)					Part Number Nozzle Only
		40	60	75	100	150	3	4	6	8	10	
White	110	1.00	1.22	1.37	1.58	1.94	4,01	4,63	5,67	6,55	7,32	30HAF01110
Cream	65	1.00	1.22	1.37	1.58	1.94	4,01	4,63	5,67	6,55	7,32	30HAF01-65
Mint Green	80	1.43	1.75	1.96	2.26	2.77	5,73	6,62	8,10	9,36	10,46	30HAF01480
White	70	1.51	1.85	2.07	2.39	2.92	6,05	6,99	8,56	9,88	11,05	30HAF01570

Features	
Common Use	Cooling & Humidification
Pattern	Fan or Hollow Cone
Technology	Elliptical Orifice or Swirl
Material	Polyacetal
Spray Angle	65-110°
Pressure Range	40-150 PSI (3-10 BAR)
Configuration	Nozzles, Push-fit, or MNPT

## Retaining Nuts for Flanged Tips



Part Number	Description
251032WH	3/8 inch BSP Retaining Nut White Polypropylene
251032GY	3/8 inch BSP Retaining Nut Gray Polypropylene
251032BL	3/8 inch BSP Retaining Nut Black Polypropylene

# Misting Nozzle Accessories

## Push-fit Anti-drip Nozzle: PF-Hollow Cone 3/8"



Color	Spray Angle	US gal/hr @ pressure (PSI)					L/hr@ pressure (bar)					Part Number with Cup Strainer
		40	60	75	100	150	3	4	6	8	10	
White	80	0.91	1.11	1.25	1.44	1.76	3,65	4,21	5,16	5,96	6,66	30PFAF008-80
Black	80	0.91	1.11	1.25	1.44	1.76	3,65	4,21	5,16	5,96	6,66	30PFAF008-80BL
White	105	1.27	1.56	1.74	2.01	2.46	5,09	5,88	7,20	8,31	9,29	30PFAF013-105
Black	105	1.27	1.56	1.74	2.01	2.46	5,09	5,88	7,20	8,31	9,29	30PFAF013-105BL



## Misting Nozzle Accessories for Push-Fit Anti-drip Nozzles

Reference Number	Part Number	Description
1	32195Q3269	Push-in Porous Plastic 250 Mesh Post Filter
2	141418	Barbed Tee 1/8 inch FNPT x 1/4 inch Barbs Black (6 mm)
2	10AEE930003	Barbed Tee 1/8 inch FNPT x 1/4 inch Barbs White (6 mm)
2	383818	Barbed Tee 1/8 inch FNPT x 3/8 inch Barbs Black (6 mm)
3	1212518	Push-in Tee 1/2 inch SLIP x 1/2 inch SLIP x 1/8 inch (F)

## 1/8" MNPT Anti-drip Nozzle: AFD-Hollow Cone



Color	Spray Angle	US gal/hr @ pressure (PSI)					L/hr@ pressure (bar)					Part Number Nozzle Only	Part Number with Cup Strainer
		40	60	75	100	150	3	4	6	8	10		
Gray	80	0.72	0.88	0.99	1.14	1.39	2,89	3,34	4,09	4,72	5,28	301AFD0.7-80	CS301AFD0.7-80
Cream	105	1.20	1.47	1.64	1.90	2.32	4,81	5,55	6,80	7,85	8,78	301AFD1.2-105	CS301AFD1.2-105
Blue	100	1.68	2.06	2.30	2.66	3.25	6,74	7,78	9,53	11,01	12,31	301AFD1.6-100	-

## 1/8" MNPT Nozzle: AF-Hollow Cone



Color	Spray Angle	US gal/hr @ pressure (PSI)					L/hr@ pressure (bar)					Part Number Nozzle Only	Part Number with SS Cup Strainer	Part Number with SS Post Strainer	Part Number with Plastic Filter
		40	60	75	100	150	3	4	6	8	10				
White	65	0.48	0.59	0.66	0.76	0.93	1,92	2,22	2,72	3,14	3,51	301AF0.4-65	CS301AF0.4-65	301AFUSA0.5	PP301AF0.4-65
Gray	80	0.72	0.88	0.99	1.14	1.39	2,89	3,34	4,09	4,72	5,28	301AF0.7-80	CS301AF0.7-80	301AFUSA1.0	PP301AF0.7-80
White	80	0.72	0.88	0.99	1.14	1.39	2,89	3,34	4,09	4,72	5,28	301AF0.7-80W	CS301MNF-W	301MNF-W	PP301AF0.7-80W
Cream	105	1.20	1.47	1.64	1.90	2.32	4,81	5,55	6,80	7,85	8,78	301AF1.2-105C	CS301AF1.2-105C	301AFUSA2.0	PP301AF1.2-105C
Blue	100	1.68	2.06	2.30	2.66	3.25	6,74	7,78	9,53	11,01	12,31	301AF1.6-100	CS301AF1.6-100	301AFUSA3.0	PP301AF1.6-100
Yellow	70	5.00	6.12	6.85	7.91	9.68	20,05	23,15	28,35	32,74	36,61	301AF5.0-70	-	-	-



## Misting Nozzle Accessories for 1/8" MNPT Nozzle

Reference Number	Part Number	Description
1	32100200	Cup Strainer 200 Mesh (Fits Rear of Threaded Misting Nozzles)
2	32PIFA250	Push-in 200 Mesh Post Strainer
3	27101612	3/8 inch BSP x 1/2 inch Wet Boom Body





# Flat Fan Spray Nozzles - Even 80°

## For Knapsack/Backpack Sprayers



The Hypro Even Flat Fan spray nozzle creates a consistent pattern that is ideal for single nozzle applications.

- Commonly used with knapsack sprayers for precise control
- 80° angle distributes a medium fine spray evenly across the swath
- Mixed droplet spectrum is ideal for all targets
- One piece design

### US Units

Nozzle Size	Droplet Size	Spray Angle	Spray Width 20 in height (in)	Pressure (PSI)	Flow Rate (GPM)	Gallons per Acre (Single Nozzle Applications) MPH			
						1	2	3	4
01	F F F	80	34	20.0	0.086	15.3	7.6	5.1	3.8
				30.0	0.098	17.3	8.7	5.8	4.3
				40.0	0.106	18.7	9.4	6.2	4.7
015	F F F	80	34	20.0	0.129	22.9	11.5	7.6	5.7
				30.0	0.145	25.7	12.9	8.6	6.4
				40.0	0.159	28.1	14.0	9.4	7.0
02	M F F	80	34	20.0	0.173	30.5	15.3	10.2	7.6
				30.0	0.193	34.1	17.1	11.4	8.5
				40.0	0.211	37.4	18.7	12.5	9.4
03	M M F	80	34	20.0	0.259	45.8	22.9	15.3	11.5
				30.0	0.291	51.4	25.7	17.1	12.9
				40.0	0.317	56.1	28.1	18.7	14.0

Droplet size based on ASABE S572.1 standard.

Application rates shown reflect single nozzle applications at walking speeds.

### Metric Units

Nozzle Size	Droplet Size	Spray Angle	Spray Width 50 cm height (m)	Pressure (BAR)	Flow Rate (LPM)	Application Rate L/ha (Single Nozzle Applications) KM/H			
						2	3	4	5
01	F F F	80	0.8	2	0.327	117	78	58	47
				2.5	0.370	132	88	66	53
				3	0.400	143	95	72	57
015	F F F	80	0.8	2	0.490	175	117	88	70
				2.5	0.550	197	131	98	79
				3	0.600	215	143	107	86
02	M F F	80	0.8	2	0.653	234	156	117	93
				2.5	0.730	261	174	130	104
				3	0.800	286	191	143	114
03	M M F	80	0.8	2	0.980	350	234	175	140
				2.5	1.100	393	262	197	157
				3	1.200	429	286	215	172

Droplet size based on ASABE S572.1 standard.

Application rates shown reflect single nozzle applications at walking speeds.

Features	
Common Use	Knapsack
Pattern	Even Flat Fan
Technology	Elliptical Orifice
Material	Polyacetal
Spray Angle	80°
Pressure Range	20-40 PSI (2-3 BAR)
Configuration	Nozzle
Part Numbers	
Nozzles 80°	Caps (25 Pack)
E80-01	CAP00-01
E80-015	CAP00-015
E80-02	CAP00-02
E80-03	CAP00-03



# DeflecTip and PoliJet 53°-127°

## For Knapsack/Backpack Sprayers



The DeflecTip and PoliJet wide-angle flood fan nozzle creates a wide pattern at very low pressures while creating mainly medium and coarse droplets. It is well suited for sprayers using very low pressures, including manual sprayers.

- Different spray angles offer a choice of swath widths
- PoliJet nozzles are designed for knapsack applications, giving a low drift, course, even spray
- Circular orifice reduces the chances of blocking

### US Units: DeflectTip

Nozzle Size	Droplet Size	Spray Angle	Spray Width 20 in height (in)	Pressure (PSI)	Flow Rate (GPM)	Gallons per Acre (Single Nozzle Application) MPH			
						1	2	3	4
DT0.5	VC	80°	34 @ 40 PSI	10.0	0.05	8.8	4.4	2.9	2.2
	M			20.0	0.07	12.4	6.2	4.1	3.1
	F			30.0	0.09	15.9	8.0	5.3	4.0
	F			40.0	0.10	17.7	8.8	5.9	4.4
DT0.75	XC	95°	44 @ 40 PSI	10.0	0.08	10.9	5.4	3.6	2.7
	M			20.0	0.11	15.0	7.5	5.0	3.7
	M			30.0	0.13	17.7	8.8	5.9	4.4
	F			40.0	0.15	20.4	10.2	6.8	5.1
DT1.0	C	105°	52 @ 40 PSI	10.0	0.10	11.4	5.7	3.8	2.8
	M			20.0	0.14	16.0	8.0	5.3	4.0
	M			30.0	0.17	19.4	9.7	6.5	4.8
	F			40.0	0.20	22.8	11.4	7.6	5.7
DT1.5	C	105°	52 @ 40 PSI	10.0	0.15	17.1	8.5	5.7	4.3
	M			20.0	0.21	23.9	12.0	8.0	6.0
	M			30.0	0.26	29.6	14.8	9.9	7.4
	M			40.0	0.30	34.2	17.1	11.4	8.5

Droplet size is based on ASABE S572.1 standard.

### Metric Units: DeflectTip

Nozzle Size	Droplet Size	Spray Angle	Spray Width 50 cm height (m)	Pressure (BAR)	Flow Rate (LPM)	Application Rate L/ha (Single Nozzle Application) KM/H			
						2	3	4	5
DT0.5	C	80°	0.8 @ 3 BAR	1	0.23	81	54	41	33
	F			2	0.32	115	77	58	46
	F			3	0.39	141	94	71	56
	F			3	0.44	157	105	79	63
DT0.75	C	95°	1.1 @ 3 BAR	1	0.34	94	63	47	38
	M			2	0.48	133	89	66	53
	M			3	0.59	163	109	81	65
	M			3	0.66	182	121	91	73
DT1.0	M	105°	1.3 @ 3 BAR	1	0.46	105	70	52	42
	M			2	0.64	148	99	74	59
	M			3	0.79	182	121	91	73
	M			3	0.88	204	136	102	80
DT1.5	M	105°	1.3 @ 3 BAR	1	0.68	157	105	79	63
	M			2	0.97	223	148	111	89
	M			3	1.18	273	182	136	109
	M			3	1.31	313	208	156	124

Droplet size is based on ASABE S572.1 standard.

### US Units: PoliJet

Nozzle Size	ASABE Droplet Size	Spray Angle	Spray Width 20 in height (in)	Pressure (PSI)	Flow Rate (GPM)	Gallons per Acre (Single Nozzle Application) MPH			
						1	2	3	4
AN0.6	C	53°	20 @ 40 PSI	10.0	0.16	47.2	23.6	15.7	11.8
	M			20.0	0.22	66.7	33.4	22.2	16.7
	M			40.0	0.27	81.7	40.9	27.2	20.4
	M			40.0	0.32	94.0	47.0	31.3	23.6
AN1.2	C	90°	40 @ 40 PSI	10.0	0.32	47.0	23.5	15.7	11.8
	M			20.0	0.45	66.5	33.3	22.2	16.6
	M			40.0	0.55	81.5	40.7	27.2	20.4
	M			40.0	0.63	94.0	47.0	31.3	23.6
AN1.8	C	113°	60 @ 40 PSI	10.0	0.48	47.2	23.6	15.7	11.8
	C			20.0	0.67	66.7	33.3	22.2	16.7
	C			40.0	0.82	81.7	40.8	27.2	20.4
	C			40.0	0.93	94.0	47.0	31.3	23.6
AN2.4	C	127°	80 @ 40 PSI	10.0	0.63	46.9	23.5	15.6	11.7
	C			20.0	0.90	66.3	33.2	22.1	16.6
	C			40.0	1.10	81.3	40.6	27.1	20.3
	C			40.0	1.23	94.0	47.0	31.3	23.6

Droplet size is based on ASABE S572.1 standard.

### Metric Units: PoliJet

Nozzle Size	BCPC Droplet Size	Spray Angle	Spray Width 50 cm height (m)	Pressure (BAR)	Flow Rate (LPM)	Application Rate L/ha (Single Nozzle Application) KM/H			
						2	3	4	5
AN0.6	C	53°	0.5 @ 3 BAR	1	0.60	361	241	181	144
	M			2	0.85	511	340	255	204
	M			3	1.04	625	417	313	250
	M			3	1.12	672	448	336	270
AN1.2	C	90°	1.0 @ 3 BAR	1	1.20	360	240	180	144
	M			2	1.70	509	339	255	204
	M			3	2.08	624	416	312	249
	M			3	2.24	672	448	336	270
AN1.8	C	113°	1.5 @ 3 BAR	1	1.80	361	241	180	144
	C			2	2.55	510	340	255	204
	C			3	3.12	625	417	312	250
	C			3	3.36	672	448	336	270
AN2.4	C	127°	2.0 @ 3 BAR	1	2.40	359	239	179	144
	C			2	3.39	508	338	254	203
	C			3	4.16	622	415	312	249
	C			3	4.48	672	448	336	270

BCPC CODING FINE MEDIUM COARSE

BCPC droplet size based on BCPC standard.

Application rates shown reflect single nozzle applications at walking speeds.

Features	
Common Use	Knapsack
Pattern	Flood
Technology	Deflection
Material	Polyacetal
Spray Angle	53°-127°
Pressure Range	15-45 PSI (1-3 BAR)
Configuration	Nozzle
DT Part Numbers	
Nozzles	Caps (25 Pack)
30DT0.5	CAP30-20
30DT0.75	CAP30-20
30DT1.0	CAP30-20
30DT1.5	CAP30-20
AN Part Numbers	
Nozzles	Caps (25 Pack)
30AN0.6	CAP30-20
30AN0.6	CAP30-20
30AN1.2	CAP30-20
30AN1.8	CAP30-20
30AN2.4	CAP30-20

# Spray Nozzle Caps and Adapters



Hypro® caps provide trouble-free spray nozzle installation and sealing on Hypro ProFlo nozzle bodies and several other common makes.

- Color-coded to ISO standards for nozzle flow to simplify nozzle selection and identification in the field
- Available in configurations optimized to fit a variety of spray nozzle geometries
- Caps for fan pattern nozzles automatically align nozzles for enhanced spray uniformity



	ISO Standard Fan	Hardi®	Deflect Nozzle No-offset	European Fan (Thick body)	Standard Round (Non-aligning)	Albuz® Round (Thick flange)	Shut-off	Threaded	
<b>Fits:</b>	ULD, GA, LD, VP, TR, OC, F, E, AXI, ADI, OCI	ULD, GA, LD, VP, TR, OC, F, E, AXI, ADI, OCI	DT, PoliJet	AVI, AVI-TWIN, ESI, APG, APE	HCX, FCX DC/CR, HAF, APM flanged hose barbs	Ceramic Disc, ATR, HCA, TVI	Blank	1/4"FNPT	Std. Pack
<b>Black</b>	CAP00-20	16842490	CAP30-20	CAP01-20	CAP04-20	CAP05-20 30Q2603-20	CAP09-20	CAP10-20	25
<b>Orange</b>	CAP00-01	-	-	CAP01-01	CAP04-01	CAP05-01	-	-	25
<b>Green</b>	CAP00-015	-	-	CAP01-015	CAP04-015	CAP05-015	-	-	25
<b>Yellow</b>	CAP00-02	-	-	CAP01-02	CAP04-02	CAP05-02	-	-	25
<b>Lilac</b>	CAP00-025	-	-	CAP01-025	CAP04-025	CAP05-025	-	-	25
<b>Blue</b>	CAP00-03	-	-	CAP01-03	CAP04-03	CAP05-03	-	-	25
<b>Brown Red</b>	CAP00-035	-	-	-	-	-	-	-	25
<b>Red</b>	CAP00-04	-	-	CAP01-04	CAP04-04	CAP05-04	-	-	25
<b>Brown</b>	CAP00-05	-	-	CAP01-05	CAP04-05	CAP05-05	-	-	25
<b>Gray</b>	CAP00-06	-	-	CAP01-06	CAP04-06	CAP05-06	-	-	25
<b>White</b>	CAP00-08	-	-	CAP01-08	CAP04-08	CAP05-08	-	-	25
<b>Light Blue</b>	CAP00-10	-	-	CAP01-10	CAP04-10	-	-	-	25
<b>Lime Green</b>	CAP00-15	-	-	CAP01-15	CAP04-15	-	-	-	25
<b>Included EPDM seal</b>	22W11MF64	16842491	22W11MF64	22W11MF64	22W11MF64	22W11MF64	-	22W11MF64	-
<b>Included EPDM o-ring</b>						402105-030			
<b>Included Nitrile seal</b>	-	-	-	-	-	-	65-BS205	-	-
<b>Separate Viton® seal</b>	22W11MF64V		22W11MF64V	22W11MF64V	22W11MF64V	22W11MF64V	65-VBS205	22W11MF64V	-

Available for order through HYPRO-EU only (Cambridge,UK)

## Push-to-Connect Spray Caps

Push-to-Connect (PTC) Cap Part Numbers			Gasket Type	Gasket part Number
Size	25 Std. Pack	1 Per Bag		
1/4"	4200-0060	BG-4200-0060	Std	22W11MF64
3/8"	4200-0061	BG-4200-0061	Std	22W11MF64
1/4"	4200-0062	BG-4200-0062	Split	10BG-1700-0255
3/8"	4200-0063	BG-4200-0063	Split	10BG-1700-0255

## Elbow and Double Adapters for Spray Nozzle Cap

Part number	Description
4200N-0017	45 Double w/ Gasket
4200N-0018	90 Elbow w/ Gasket
2270-0136	Cap Filler Disk

## Hardi® and Jacto® Adapters

Part Number	Adapters For	Description
9950-0024	Hardi	10 pack of adapters for converting nozzle body to accept Hypro cap
9950-0027	Jacto	

Hardi is a registered trademark of Hardi International A/S. Jacto is a registered trademark of Jacto Inc. All other brand or product names are trademarks or registered trademarks of Pentair Ltd. Viton® is a registered trademark of DuPont. Hypro® is a registered trademark of Pentair.



# Spray Nozzle Cap – TwinCap



The Hypro® TwinCap is a simple, compact way of accommodating two spray nozzles back to back. This design allows you to apply the volume per acre you want, at the speed you want, without compromising spray quality.

- Improve control of plant diseases, insects, and difficult weeds
- Twin 30° angles improve canopy penetration
- Combined forward and backward angles enhance coverage on stems and leaves
- Holds any two standard dimension nozzles, including Hypro ULD, GA, LD, ADI, VP, TR, AXI, Flat, and Even nozzles
- User can select nozzles for the most effective spray
- Available in standard Polyacetal or in Gray PVDF for acid sprays

Part Numbers	
TwinCaps, less nozzles	
152607TC	Standard TwinCap for agrochemicals
15Q2530TC	Gray Acid-resistant Twin cap for defoliants
VPTCAP	Standard TwinCap with one exit blanked for a single angled spray
16Q2530TC	Hardi TwinCap
Replacement Parts	
22W11MF64	Standard cap seal (A)
22W11MF64V	Viton cap seal for Acid (A)
65MN011X1.3	Standard nozzle o-ring seal (B)
65VBS0113-13	Viton nozzle o-ring seal for Acid (B)
30Q3834	Replacement VPTCAP plug

## Nozzle Strainers



1



2



3



4

Ref #	Part Number	ISO Color	Mesh	Material	Description	
1	TS01-50	Blue	50	Polypropylene	Premium flow nozzle strainer	
1	TS01-100	Green	100		Premium flow nozzle strainer for Guardian & GuardianAIR Twin	
2	TS02-50	Blue	50		Nylon	Slotted nozzle strainer
2	TS02-100	Green	100			
3	TS03-25	Black	25	Stainless Steel	Nozzle filter with check	
4	32100530	White	30			
4	32100550	Blue	50		Nozzle filter without check	
4	32100510	Green	100			
4	32100050	Blue	50			
4	32100010	Green	100			

### General Strainer Recommendations

Nozzle Flow Rate at 40 PSI (2.8 BAR)	Strainer Mesh	Example Fan Nozzle Size
Less than 0.10	200	005-0067
0.10-0.39	100	01-035
0.40-0.79	50	04-06
0.80-2.00	25	08-20

# Spray Demonstration Tables



- Plastic molded portable demonstration table with open see-through design.
- Clear 1" boom featuring three 5-way ProFlo nozzle bodies and Express End Caps and Express Tee.
- Lightweight design for easy transportation and storage.
- Powered by 115 VAC or 220 VAC SHURflo pump with filter.
- Standard Boom Addition - Clear 1" boom featuring three 5-way ProFlo nozzle bodies with standard boom ends.
- Use with Express End Cap boom (provided with table) & standard boom (3430-0017) for visual demonstration of Express End Cap benefits.

Part Number	Description
3040-0015	Standard spray table 115VAC, comes with express fittings boom and spray nozzle kit.
3040-0016	Standard Spray table 220VAC, comes with express fittings boom and spray nozzle kit.
3040-0017	Addition boom with dead end - to allow demonstration of that along with express end cap boom.
3040-0018	ProStop-E Boom Addition
3040-0019	DuoReact Boom Addition
3040-0020	Carrying Case

# Spray Nozzle Calibration Tools

Reference Number	Part Number	Description
1	9950-0022	34 oz. Calibration Jug
1	9950-0023	100 oz. Calibration Jug
2	9950-0031	Spray Nozzle Calibration pressure gauge
3	9950-0028	Water Sensitive paper (50 pack) 76x26mm (instructions included)

1



2



3



# Broadcast and Turf Application Chart-20" Spacing

Nozzle Size	Pressure (PSI)	Flow Rate (GPM)	Gallons per Acre 20-inch Nozzle Spacing										GAL/1000 Ft <sup>2</sup> 20-inch Nozzle Spacing				
			MPH										MPH				
			4	5	6	7	8	10	12	14	16	18	20	2	3	4	5
01	15	0.06	4.5	3.6	3.0	2.5	2.2	1.8	1.5	1.3	1.1	1.0	0.9	0.20	0.14	0.10	0.08
	30	0.09	6.7	5.3	4.5	3.8	3.3	2.7	2.2	1.9	1.7	1.5	1.3	0.31	0.20	0.15	0.12
	40	0.10	7.4	5.9	5.0	4.2	3.7	3.0	2.5	2.1	1.9	1.7	1.5	0.34	0.23	0.17	0.14
	60	0.12	8.9	7.1	5.9	5.1	4.5	3.6	3.0	2.5	2.2	2.0	1.8	0.41	0.27	0.20	0.16
	80	0.14	10.4	8.3	6.9	5.9	5.2	4.2	3.5	3.0	2.6	2.3	2.1	0.48	0.32	0.24	0.19
	100	0.16	11.9	9.5	7.9	6.8	5.9	4.8	4.0	3.4	3.0	2.6	2.4	0.55	0.36	0.27	0.22
115	0.17	12.6	10.1	8.4	7.2	6.3	5.0	4.2	3.6	3.2	2.8	2.5	0.58	0.39	0.29	0.23	
015	15	0.09	6.7	5.3	4.5	3.8	3.3	2.7	2.2	1.9	1.7	1.5	1.3	0.31	0.20	0.15	0.12
	30	0.13	9.7	7.7	6.4	5.5	4.8	3.9	3.2	2.8	2.4	2.1	1.9	0.44	0.30	0.22	0.18
	40	0.15	11.1	8.9	7.4	6.4	5.6	4.5	3.7	3.2	2.8	2.5	2.2	0.51	0.34	0.26	0.20
	60	0.18	13.4	10.7	8.9	7.6	6.7	5.3	4.5	3.8	3.3	3.0	2.7	0.61	0.41	0.31	0.25
	80	0.21	15.6	12.5	10.4	8.9	7.8	6.2	5.2	4.5	3.9	3.5	3.1	0.72	0.48	0.36	0.29
	100	0.24	17.8	14.3	11.9	10.2	8.9	7.1	5.9	5.1	4.5	4.0	3.6	0.82	0.55	0.41	0.33
115	0.25	18.6	14.9	12.4	10.6	9.3	7.4	6.2	5.3	4.6	4.1	3.7	0.85	0.57	0.43	0.34	
02	15	0.12	8.9	7.1	5.9	5.1	4.5	3.6	3.0	2.5	2.2	2.0	1.8	0.41	0.27	0.20	0.16
	30	0.17	12.6	10.1	8.4	7.2	6.3	5.0	4.2	3.6	3.2	2.8	2.5	0.58	0.39	0.29	0.23
	40	0.20	14.9	11.9	9.9	8.5	7.4	5.9	5.0	4.2	3.7	3.3	3.0	0.68	0.45	0.34	0.27
	60	0.24	17.8	14.3	11.9	10.2	8.9	7.1	5.9	5.1	4.5	4.0	3.6	0.82	0.55	0.41	0.33
	80	0.28	20.8	16.6	13.9	11.9	10.4	8.3	6.9	5.9	5.2	4.6	4.2	0.95	0.64	0.48	0.38
	100	0.32	23.8	19.0	15.8	13.6	11.9	9.5	7.9	6.8	5.9	5.3	4.8	1.09	0.73	0.55	0.44
115	0.34	25.2	20.2	16.8	14.4	12.6	10.1	8.4	7.2	6.3	5.6	5.0	1.16	0.77	0.58	0.46	
025	15	0.15	11.1	8.9	7.4	6.4	5.6	4.5	3.7	3.2	2.8	2.5	2.2	0.51	0.34	0.26	0.20
	30	0.22	16.3	13.1	10.9	9.3	8.2	6.5	5.4	4.7	4.1	3.6	3.3	0.75	0.50	0.38	0.30
	40	0.25	18.6	14.9	12.4	10.6	9.3	7.4	6.2	5.3	4.6	4.1	3.7	0.85	0.57	0.43	0.34
	60	0.31	23.0	18.4	15.3	13.2	11.5	9.2	7.7	6.6	5.8	5.1	4.6	1.06	0.70	0.53	0.42
	80	0.35	26.0	20.8	17.3	14.9	13.0	10.4	8.7	7.4	6.5	5.8	5.2	1.19	0.80	0.60	0.48
	100	0.40	29.7	23.8	19.8	17.0	14.9	11.9	9.9	8.5	7.4	6.6	5.9	1.36	0.91	0.68	0.55
115	0.42	31.2	24.9	20.8	17.8	15.6	12.5	10.4	8.9	7.8	6.9	6.2	1.43	0.95	0.72	0.57	
03	15	0.18	13.4	10.7	8.9	7.6	6.7	5.3	4.5	3.8	3.3	3.0	2.7	0.61	0.41	0.31	0.25
	30	0.26	19.3	15.4	12.9	11.0	9.7	7.7	6.4	5.5	4.8	4.3	3.9	0.89	0.59	0.44	0.35
	40	0.30	22.3	17.8	14.9	12.7	11.1	8.9	7.4	6.4	5.6	5.0	4.5	1.02	0.68	0.51	0.41
	60	0.37	27.5	22.0	18.3	15.7	13.7	11.0	9.2	7.8	6.9	6.1	5.5	1.26	0.84	0.63	0.50
	80	0.42	31.2	24.9	20.8	17.8	15.6	12.5	10.4	8.9	7.8	6.9	6.2	1.43	0.95	0.72	0.57
	100	0.47	34.9	27.9	23.3	19.9	17.4	14.0	11.6	10.0	8.7	7.8	7.0	1.60	1.07	0.80	0.64
115	0.51	37.9	30.3	25.2	21.6	18.9	15.1	12.6	10.8	9.5	8.4	7.6	1.74	1.16	0.87	0.70	
035	15	0.21	15.6	12.5	10.4	8.9	7.8	6.2	5.2	4.5	3.9	3.5	3.1	0.72	0.48	0.36	0.29
	30	0.30	22.3	17.8	14.9	12.7	11.1	8.9	7.4	6.4	5.6	5.0	4.5	1.02	0.68	0.51	0.41
	40	0.35	26.0	20.8	17.3	14.9	13.0	10.4	8.7	7.4	6.5	5.8	5.2	1.19	0.80	0.60	0.48
	60	0.43	31.9	25.5	21.3	18.2	16.0	12.8	10.6	9.1	8.0	7.1	6.4	1.47	0.98	0.73	0.59
	80	0.49	36.4	29.1	24.3	20.8	18.2	14.6	12.1	10.4	9.1	8.1	7.3	1.67	1.11	0.84	0.67
	100	0.55	40.8	32.7	27.2	23.3	20.4	16.3	13.6	11.7	10.2	9.1	8.2	1.88	1.25	0.94	0.75
115	0.59	43.8	35.0	29.2	25.0	21.9	17.5	14.6	12.5	11.0	9.7	8.8	2.01	1.34	1.01	0.80	
04	15	0.24	17.8	14.3	11.9	10.2	8.9	7.1	5.9	5.1	4.5	4.0	3.6	0.82	0.55	0.41	0.33
	30	0.35	26.0	20.8	17.3	14.9	13.0	10.4	8.7	7.4	6.5	5.8	5.2	1.19	0.80	0.60	0.48
	40	0.40	29.7	23.8	19.8	17.0	14.9	11.9	9.9	8.5	7.4	6.6	5.9	1.36	0.91	0.68	0.55
	60	0.49	36.4	29.1	24.3	20.8	18.2	14.6	12.1	10.4	9.1	8.1	7.3	1.67	1.11	0.84	0.67
	80	0.57	42.3	33.9	28.2	24.2	21.2	16.9	14.1	12.1	10.6	9.4	8.5	1.94	1.30	0.97	0.78
	100	0.63	46.8	37.4	31.2	26.7	23.4	18.7	15.6	13.4	11.7	10.4	9.4	2.15	1.43	1.07	0.86
115	0.68	50.5	40.4	33.7	28.9	25.2	20.2	16.8	14.4	12.6	11.2	10.1	2.32	1.55	1.16	0.93	
05	15	0.31	23.0	18.4	15.3	13.2	11.5	9.2	7.7	6.6	5.8	5.1	4.6	1.06	0.70	0.53	0.42
	30	0.43	31.9	25.5	21.3	18.2	16.0	12.8	10.6	9.1	8.0	7.1	6.4	1.47	0.98	0.73	0.59
	40	0.50	37.1	29.7	24.8	21.2	18.6	14.9	12.4	10.6	9.3	8.3	7.4	1.71	1.14	0.85	0.68
	60	0.61	45.3	36.2	30.2	25.9	22.6	18.1	15.1	12.9	11.3	10.1	9.1	2.08	1.39	1.04	0.83
	80	0.71	52.7	42.2	35.1	30.1	26.4	21.1	17.6	15.1	13.2	11.7	10.5	2.42	1.61	1.21	0.97
	100	0.79	58.7	46.9	39.1	33.5	29.3	23.5	19.6	16.8	14.7	13.0	11.7	2.69	1.80	1.35	1.08
115	0.85	63.1	50.5	42.1	36.1	31.6	25.2	21.0	18.0	15.8	14.0	12.6	2.90	1.93	1.45	1.16	
06	15	0.37	27.5	22.0	18.3	15.7	13.7	11.0	9.2	7.8	6.9	6.1	5.5	1.26	0.84	0.63	0.50
	30	0.52	38.6	30.9	25.7	22.1	19.3	15.4	12.9	11.0	9.7	8.6	7.7	1.77	1.18	0.89	0.71
	40	0.60	44.6	35.6	29.7	25.5	22.3	17.8	14.9	12.7	11.1	9.9	8.9	2.05	1.36	1.02	0.82
	60	0.73	54.2	43.4	36.1	31.0	27.1	21.7	18.1	15.5	13.6	12.0	10.8	2.49	1.66	1.24	1.00
	80	0.85	63.1	50.5	42.1	36.1	31.6	25.2	21.0	18.0	15.8	14.0	12.6	2.90	1.93	1.45	1.16
	100	0.95	70.5	56.4	47.0	40.3	35.3	28.2	23.5	20.2	17.6	15.7	14.1	3.24	2.16	1.62	1.30
115	1.02	75.7	60.6	50.5	43.3	37.9	30.3	25.2	21.6	18.9	16.8	15.1	3.48	2.32	1.74	1.39	
08	15	0.49	36.4	29.1	24.3	20.8	18.2	14.6	12.1	10.4	9.1	8.1	7.3	1.67	1.11	0.84	0.67
	30	0.69	51.2	41.0	34.2	29.3	25.6	20.5	17.1	14.6	12.8	11.4	10.2	2.35	1.57	1.18	0.94
	40	0.80	59.4	47.5	39.6	33.9	29.7	23.8	19.8	17.0	14.9	13.2	11.9	2.73	1.82	1.36	1.09
	60	0.98	72.8	58.2	48.5	41.6	36.4	29.1	24.3	20.8	18.2	16.2	14.6	3.34	2.23	1.67	1.34
	80	1.13	83.9	67.1	55.9	47.9	42.0	33.6	28.0	24.0	21.0	18.6	16.8	3.85	2.57	1.93	1.54
	100	1.26	93.6	74.8	62.4	53.5	46.8	37.4	31.2	26.7	23.4	20.8	18.7	4.30	2.86	2.15	1.72
115	1.36	101.0	80.8	67.3	57.7	50.5	40.4	33.7	28.9	25.2	22.4	20.2	4.64	3.09	2.32	1.86	
10	15	0.61	45.3	36.2	30.2	25.9	22.6	18.1	15.1	12.9	11.3	10.1	9.1	2.08	1.39	1.04	0.83
	30	0.87	64.6	51.7	43.1	36.9	32.3	25.8	21.5	18.5	16.1	14.4	12.9	2.97	1.98	1.48	1.19
	40	1.00	74.3	59.4	49.5	42.4	37.1	29.7	24.8	21.2	18.6	16.5	14.9	3.41	2.27	1.71	1.36
	60	1.22	90.6	72.5	60.4	51.8	45.3	36.2	30.2	25.9	22.6	20.1	18.1	4.16	2.77	2.08	1.66
	80	1.41	104.7	83.8	69.8	59.8	52.3	41.9	34.9	29.9	26.2	23.3	20.9	4.81	3.21	2.40	1.92
	100	1.58	117.3	93.9	78.2	67.0	58.7	46.9	39.1	33.5	29.3	26.1	23.5	5.39	3.59	2.69	2.16
115	1.70	126.2	101.0	84.2	72.1	63.1	50.5	42.1	36.1	31.6	28.1	25.2	5.80	3.86	2.90	2.32	
15	15	0.92	68.3	54.6	45.5	39.0	34.2	27.3	22.8	19.5	17.1	15.2	13.7	3.14	2.09	1.57	1.25
	30	1.30	96.5	77.2	64.4	55.2	48.3	38.6									

# Hi-Flow Application Chart - 20", 40" & 60" Spacing

Nozzle Size	PSI	GPM	Application Rate (GPA) 20 inch spacing								Application Rate (GPA) 40 inch spacing								Application Rate (GPA) 60 inch spacing							
			MPH								MPH								MPH							
			5	6	8	10	12	14	16	5	6	8	10	12	14	16	5	6	8	10	12	14	16			
08	20	0.57	34	28	21	17	14	12	11	17	14	11	8	7	6	5	11	9	7	6	5	4	4			
	30	0.69	41	34	26	20	17	15	13	20	17	13	10	9	7	6	14	11	9	7	6	5	4			
	40	0.80	48	40	30	24	20	17	15	24	20	15	12	10	8	7	16	13	10	8	7	6	5			
	50	0.89	53	44	33	26	22	19	17	26	22	17	13	11	9	8	18	15	11	9	7	6	6			
	60	0.98	58	49	36	29	24	21	18	29	24	18	15	12	10	9	19	16	12	10	8	7	6			
	70	1.06	63	52	39	31	26	22	20	31	26	20	16	13	11	10	21	17	13	10	9	7	7			
	80	1.13	67	56	42	34	28	24	21	34	28	21	17	14	12	10	22	19	14	11	9	8	7			
	10	20	0.71	42	35	26	21	18	15	13	21	18	13	11	9	8	7	14	12	9	7	6	5	4		
30		0.87	52	43	32	26	22	18	16	26	22	16	13	11	9	8	17	14	11	9	7	6	5			
40		1.00	59	50	37	30	25	21	19	30	25	19	15	12	11	9	20	17	12	10	8	7	6			
50		1.12	67	55	42	33	28	24	21	33	28	21	17	14	12	10	22	18	14	11	9	8	7			
60		1.22	72	60	45	36	30	26	23	36	30	23	18	15	13	11	24	20	15	12	10	9	8			
70		1.32	78	65	49	39	33	28	25	39	33	25	20	16	14	12	26	22	16	13	11	9	8			
80		1.41	84	70	52	42	35	30	26	42	35	26	21	17	15	13	28	23	17	14	12	10	9			
15		20	1.06	63	52	39	31	26	22	20	31	26	20	16	13	11	10	21	17	13	10	9	7	7		
	30	1.30	77	64	48	39	32	28	24	39	32	24	19	16	14	12	26	21	16	13	11	9	8			
	40	1.50	89	74	56	45	37	32	28	45	37	28	22	19	16	14	30	25	19	15	12	11	9			
	50	1.68	100	83	62	50	42	36	31	50	42	31	25	21	18	16	33	28	21	17	14	12	10			
	60	1.84	109	91	68	55	46	39	34	55	46	34	27	23	20	17	36	30	23	18	15	13	11			
	70	2.0	119	99	74	59	50	42	37	59	50	37	30	25	21	19	40	33	25	20	17	14	12			
	80	2.1	125	104	78	62	52	45	39	62	52	39	31	26	22	19	42	35	26	21	17	15	13			
	20	20	1.41	84	70	52	42	35	30	26	42	35	26	21	17	15	13	28	23	17	14	12	10	9		
30		1.73	103	86	64	51	43	37	32	51	43	32	26	21	18	16	34	29	21	17	14	12	11			
40		2.0	119	99	74	59	50	42	37	59	50	37	30	25	21	19	40	33	25	20	17	14	12			
50		2.2	131	109	82	65	54	47	41	65	54	41	33	27	23	20	44	36	27	22	18	16	14			
60		2.4	143	119	89	71	59	51	45	71	59	45	36	30	25	22	48	40	30	24	20	17	15			
70		2.6	154	129	97	77	64	55	48	77	64	48	39	32	28	24	51	43	32	26	21	18	16			
80		2.8	166	139	104	83	69	59	52	83	69	52	42	35	30	26	55	46	35	28	23	20	17			
30		20	2.1	125	104	78	62	52	45	39	62	52	39	31	26	22	19	42	35	26	21	17	15	13		
	30	2.6	154	129	97	77	64	55	48	77	64	48	39	32	28	24	51	43	32	26	21	18	16			
	40	3.0	178	149	111	89	74	64	56	89	74	56	45	37	32	28	59	50	37	30	25	21	19			
	50	3.4	202	168	126	101	84	72	63	101	84	63	50	42	36	32	67	56	42	34	28	24	21			
	60	3.7	220	183	137	110	92	78	69	110	92	69	55	46	39	34	73	61	46	37	31	26	23			
	70	4.0	238	198	149	119	99	85	74	119	99	74	59	50	42	37	79	66	50	40	33	28	25			
	80	4.2	249	208	156	125	104	89	78	125	104	78	62	52	45	39	83	69	52	42	35	30	26			
	40	20	2.8	166	139	104	83	69	59	52	83	69	52	42	35	30	26	55	46	35	28	23	20	17		
30		3.5	208	173	130	104	87	74	65	104	87	65	52	43	37	32	69	58	43	35	29	25	22			
40		4.0	238	198	149	119	99	85	74	119	99	74	59	50	42	37	79	66	50	40	33	28	25			
50		4.5	267	223	167	134	111	95	84	134	111	84	67	56	48	42	89	74	56	45	37	32	28			
60		4.9	291	243	182	146	121	104	91	146	121	91	73	61	52	45	97	81	61	49	40	35	30			
70		5.3	315	262	197	157	131	112	98	157	131	98	79	66	56	49	105	87	66	52	44	37	33			
80		5.7	339	282	212	169	141	121	106	169	141	106	85	71	60	53	113	94	71	56	47	40	35			
50		20	3.5	208	173	130	104	87	74	65	104	87	65	52	43	37	32	69	58	43	35	29	25	22		
	30	4.3	255	213	160	128	106	91	80	128	106	80	64	53	46	40	85	71	53	43	35	30	27			
	40	5.0	297	248	186	149	124	106	93	149	124	93	74	62	53	46	99	83	62	50	41	35	31			
	50	5.6	333	277	208	166	139	119	104	166	139	104	83	69	59	52	111	92	69	55	46	40	35			
	60	6.1	362	302	226	181	151	129	113	181	151	113	91	75	65	57	121	101	75	60	50	43	38			
	70	6.6	392	327	245	196	163	140	123	196	163	123	98	82	70	61	131	109	82	65	54	47	41			
	80	7.1	422	351	264	211	176	151	132	211	176	132	105	88	75	66	141	117	88	70	59	50	44			
	60	20	4.2	249	208	156	125	104	89	78	125	104	78	62	52	45	39	83	69	52	42	35	30	26		
30		5.2	309	257	193	154	129	110	97	154	129	97	77	64	55	48	103	86	64	51	43	37	32			
40		6.0	356	297	223	178	149	127	111	178	149	111	89	74	64	56	119	99	74	59	50	42	37			
50		6.7	398	332	249	199	166	142	124	199	166	124	99	83	71	62	133	111	83	66	55	47	41			
60		7.3	434	361	271	217	181	155	136	217	181	136	108	90	77	68	145	120	90	72	60	52	45			
70		7.9	469	391	293	235	196	168	147	235	196	147	117	98	84	73	156	130	98	78	65	56	49			
80		8.5	505	421	316	252	210	180	158	252	210	158	126	105	90	79	168	140	105	84	70	60	53			

# Broadcast and Turf Application Chart-15" Spacing

Nozzle Size	Pressure (PSI)	Flow Rate (GPM)	Gallons per Acre 15-inch Nozzle Spacing										GAL/1000 <sup>sq ft</sup> 15-inch Nozzle Spacing				
			MPH										MPH				
			4	5	6	7	8	10	12	14	16	18	20	2	3	4	5
01	15	0.06	6.1	4.8	4.0	3.5	3.0	2.4	2.0	1.7	1.5	1.3	1.2	0.28	0.19	0.14	0.11
	30	0.09	8.6	6.9	5.7	4.9	4.3	3.4	2.9	2.4	2.1	1.9	1.7	0.39	0.26	0.20	0.16
	40	0.10	9.9	7.9	6.6	5.7	5.0	4.0	3.3	2.8	2.5	2.2	2.0	0.45	0.30	0.23	0.18
	60	0.12	12.1	9.7	8.1	6.9	6.1	4.8	4.0	3.5	3.0	2.7	2.4	0.56	0.37	0.28	0.22
	80	0.14	14.0	11.2	9.3	8.0	7.0	5.6	4.7	4.0	3.5	3.1	2.8	0.64	0.43	0.32	0.26
	100	0.16	15.7	12.5	10.4	8.9	7.8	6.3	5.2	4.5	3.9	3.5	3.1	0.72	0.48	0.36	0.29
115	0.17	16.8	13.4	11.2	9.6	8.4	6.7	5.6	4.8	4.2	3.7	3.4	0.77	0.51	0.39	0.31	
015	15	0.09	9.1	7.3	6.1	5.2	4.5	3.6	3.0	2.6	2.3	2.0	1.8	0.42	0.28	0.21	0.17
	30	0.13	12.9	10.3	8.6	7.3	6.4	5.1	4.3	3.7	3.2	2.9	2.6	0.59	0.39	0.30	0.24
	40	0.15	14.9	11.9	9.9	8.5	7.4	5.9	5.0	4.2	3.7	3.3	3.0	0.68	0.45	0.34	0.27
	60	0.18	18.2	14.5	12.1	10.4	9.1	7.3	6.1	5.2	4.5	4.0	3.6	0.84	0.56	0.42	0.33
	80	0.21	21.0	16.8	14.0	12.0	10.5	8.4	7.0	6.0	5.3	4.7	4.2	0.96	0.64	0.48	0.39
	100	0.24	23.5	18.8	15.7	13.4	11.7	9.4	7.8	6.7	5.9	5.2	4.7	1.08	0.72	0.54	0.43
115	0.25	25.2	20.1	16.8	14.4	12.6	10.1	8.4	7.2	6.3	5.6	5.0	1.16	0.77	0.58	0.46	
02	15	0.12	12.1	9.7	8.1	6.9	6.1	4.8	4.0	3.5	3.0	2.7	2.4	0.56	0.37	0.28	0.22
	30	0.17	17.1	13.7	11.4	9.8	8.6	6.9	5.7	4.9	4.3	3.8	3.4	0.79	0.53	0.39	0.32
	40	0.20	19.8	15.8	13.2	11.3	9.9	7.9	6.6	5.7	5.0	4.4	4.0	0.91	0.61	0.45	0.36
	60	0.24	24.2	19.4	16.2	13.9	12.1	9.7	8.1	6.9	6.1	5.4	4.8	1.11	0.74	0.56	0.45
	80	0.28	28.0	22.4	18.7	16.0	14.0	11.2	9.3	8.0	7.0	6.2	5.6	1.29	0.86	0.64	0.51
	100	0.32	31.3	25.1	20.9	17.9	15.7	12.5	10.4	8.9	7.8	7.0	6.3	1.44	0.96	0.72	0.58
115	0.34	33.6	26.9	22.4	19.2	16.8	13.4	11.2	9.6	8.4	7.5	6.7	1.54	1.03	0.77	0.62	
025	15	0.15	15.2	12.1	10.1	8.7	7.6	6.1	5.1	4.3	3.8	3.4	3.0	0.70	0.46	0.35	0.28
	30	0.22	21.4	17.1	14.3	12.2	10.7	8.6	7.1	6.1	5.4	4.8	4.3	0.98	0.66	0.49	0.39
	40	0.25	24.8	19.8	16.5	14.1	12.4	9.9	8.3	7.1	6.2	5.5	5.0	1.14	0.76	0.57	0.45
	60	0.31	30.3	24.2	20.2	17.3	15.2	12.1	10.1	8.7	7.6	6.7	6.1	1.39	0.93	0.70	0.56
	80	0.35	35.0	28.0	23.3	20.0	17.5	14.0	11.7	10.0	8.8	7.8	7.0	1.61	1.07	0.80	0.64
	100	0.40	39.1	31.3	26.1	22.4	19.6	15.7	13.0	11.2	9.8	8.7	7.8	1.80	1.20	0.90	0.72
115	0.42	42.0	33.6	28.0	24.0	21.0	16.8	14.0	12.0	10.5	9.3	8.4	1.93	1.28	0.96	0.77	
03	15	0.18	18.2	14.5	12.1	10.4	9.1	7.3	6.1	5.2	4.5	4.0	3.6	0.84	0.56	0.42	0.33
	30	0.26	25.7	20.6	17.1	14.7	12.9	10.3	8.6	7.3	6.4	5.7	5.1	1.18	0.79	0.59	0.47
	40	0.30	29.7	23.8	19.8	17.0	14.9	11.9	9.9	8.5	7.4	6.6	5.9	1.36	0.91	0.68	0.55
	60	0.37	36.4	29.1	24.2	20.8	18.2	14.5	12.1	10.4	9.1	8.1	7.3	1.67	1.11	0.84	0.67
	80	0.42	42.0	33.6	28.0	24.0	21.0	16.8	14.0	12.0	10.5	9.3	8.4	1.93	1.29	0.96	0.77
	100	0.47	47.0	37.6	31.3	26.8	23.5	18.8	15.7	13.4	11.7	10.4	9.4	2.16	1.44	1.08	0.86
115	0.51	50.4	40.3	33.6	28.8	25.2	20.1	16.8	14.4	12.6	11.2	10.1	2.31	1.54	1.16	0.93	
035	15	0.21	21.2	17.0	14.1	12.1	10.6	8.5	7.1	6.1	5.3	4.7	4.2	0.97	0.65	0.49	0.39
	30	0.30	30.0	24.0	20.0	17.1	15.0	12.0	10.0	8.6	7.5	6.7	6.0	1.38	0.92	0.69	0.55
	40	0.35	34.6	27.7	23.1	19.8	17.3	13.9	11.6	9.9	8.7	7.7	6.9	1.59	1.06	0.80	0.64
	60	0.43	42.4	33.9	28.3	24.2	21.2	17.0	14.1	12.1	10.6	9.4	8.5	1.95	1.30	0.97	0.78
	80	0.49	49.0	39.2	32.7	28.0	24.5	19.6	16.3	14.0	12.3	10.9	9.8	2.25	1.50	1.13	0.90
	100	0.55	54.8	43.8	36.5	31.3	27.4	21.9	18.3	15.7	13.7	12.2	11.0	2.52	1.68	1.26	1.01
115	0.59	58.8	47.0	39.2	33.6	29.4	23.5	19.6	16.8	14.7	13.1	11.8	2.70	1.80	1.35	1.08	
04	15	0.24	24.2	19.4	16.2	13.9	12.1	9.7	8.1	6.9	6.1	5.4	4.8	1.11	0.74	0.56	0.45
	30	0.35	34.3	27.4	22.9	19.6	17.1	13.7	11.4	9.8	8.6	7.6	6.9	1.58	1.05	0.79	0.63
	40	0.40	39.6	31.7	26.4	22.6	19.8	15.8	13.2	11.3	9.9	8.8	7.9	1.82	1.21	0.91	0.73
	60	0.49	48.5	38.8	32.3	27.7	24.2	19.4	16.2	13.9	12.1	10.8	9.7	2.23	1.48	1.11	0.89
	80	0.57	56.0	44.8	37.3	32.0	28.0	22.4	18.7	16.0	14.0	12.4	11.2	2.57	1.71	1.29	1.03
	100	0.63	62.6	50.1	41.7	35.8	31.3	25.1	20.9	17.9	15.7	13.9	12.5	2.88	1.92	1.44	1.15
115	0.68	67.1	53.7	44.8	38.4	33.6	26.9	22.4	19.2	16.8	14.9	13.4	3.08	2.06	1.54	1.23	
05	15	0.31	30.3	24.2	20.2	17.3	15.2	12.1	10.1	8.7	7.6	6.7	6.1	1.39	0.93	0.70	0.56
	30	0.43	42.9	34.3	28.6	24.5	21.4	17.1	14.3	12.2	10.7	9.5	8.6	1.97	1.31	0.98	0.79
	40	0.50	49.5	39.6	33.0	28.3	24.8	19.8	16.5	14.1	12.4	11.0	9.9	2.27	1.52	1.14	0.91
	60	0.61	60.6	48.5	40.4	34.6	30.3	24.2	20.2	17.3	15.2	13.5	12.1	2.78	1.86	1.39	1.11
	80	0.71	70.0	56.0	46.7	40.0	35.0	28.0	23.3	20.0	17.5	15.6	14.0	3.21	2.14	1.61	1.29
	100	0.79	78.3	62.6	52.2	44.7	39.1	31.3	26.1	22.4	19.6	17.4	15.7	3.59	2.40	1.80	1.44
115	0.85	83.9	67.1	56.0	48.0	42.0	33.6	28.0	24.0	21.0	18.7	16.8	3.85	2.57	1.93	1.54	
06	15	0.37	36.4	29.1	24.2	20.8	18.2	14.5	12.1	10.4	9.1	8.1	7.3	1.67	1.11	0.84	0.67
	30	0.52	51.4	41.2	34.3	29.4	25.7	20.6	17.1	14.7	12.9	11.4	10.3	2.36	1.58	1.18	0.95
	40	0.60	59.4	47.5	39.6	33.9	29.7	23.8	19.8	17.0	14.9	13.2	11.9	2.73	1.82	1.36	1.09
	60	0.73	72.7	58.2	48.5	41.6	36.4	29.1	24.2	20.8	18.2	16.2	14.5	3.34	2.23	1.67	1.34
	80	0.85	84.0	67.2	56.0	48.0	42.0	33.6	28.0	24.0	21.0	18.7	16.8	3.86	2.57	1.93	1.54
	100	0.95	93.9	75.1	62.6	53.7	47.0	37.6	31.3	26.8	23.5	20.9	18.8	4.31	2.88	2.16	1.73
115	1.02	100.7	80.6	67.1	57.6	50.4	40.3	33.6	28.8	25.2	22.4	20.1	4.63	3.08	2.31	1.85	
08	15	0.49	48.5	38.8	32.3	27.7	24.2	19.4	16.2	13.9	12.1	10.8	9.7	2.23	1.48	1.11	0.89
	30	0.69	68.6	54.9	45.7	39.2	34.3	27.4	22.9	19.6	17.1	15.2	13.7	3.15	2.10	1.58	1.26
	40	0.80	79.2	63.4	52.8	45.3	39.6	31.7	26.4	22.6	19.8	17.6	15.8	3.64	2.42	1.82	1.45
	60	0.98	97.0	77.6	64.7	55.4	48.5	38.8	32.3	27.7	24.2	21.6	19.4	4.45	2.97	2.23	1.78
	80	1.13	112.0	89.6	74.7	64.0	56.0	44.8	37.3	32.0	28.0	24.9	22.4	5.14	3.43	2.57	2.06
	100	1.26	125.2	100.2	83.5	71.6	62.6	50.1	41.7	35.8	31.3	27.8	25.1	5.75	3.83	2.88	2.30
115	1.36	134.3	107.4	89.5	76.7	67.1	53.7	44.8	38.4	33.6	29.8	26.9	6.17	4.11	3.08	2.47	
10	15	0.61	60.6	48.5	40.4	34.6	30.3	24.2	20.2	17.3	15.2	13.5	12.1	2.78	1.86	1.39	1.11
	30	0.87	85.7	68.6	57.2	49.0	42.9	34.3	28.6	24.5	21.4	19.1	17.1	3.94	2.63	1.97	1.58
	40	1.00	99.0	79.2	66.0	56.6	49.5	39.6	33.0	28.3	24.8	22.0	19.8	4.55	3.03	2.27	1.82
	60	1.22	121.2	97.0	80.8	69.3	60.6	48.5	40.4	34.6	30.3	26.9	24.2	5.57	3.71	2.78	2.23
	80	1.41	140.0	112.0	93.3	80.0	70.0	56.0	46.7	40.0	35.0	31.1	28.0	6.43	4.29	3.21	2.57
	100	1.58	156.5	125.2	104.4	89.4	78.3	62.6	52.2	44.7	39.1	34.8	31.3	7.19	4.79	3.59	2.88
115	1.70	167.9	134.3	111.9	95.9	83.9	6										



# Hi-Flow Application Chart - 15", 30" & 45" Spacing

Nozzle Size	PSI	GPM	Application Rate (GPA) 15 inch spacing								Application Rate (GPA) 30 inch spacing								Application Rate (GPA) 45 inch spacing							
			MPH								MPH								MPH							
			5	6	8	10	12	14	16		5	6	8	10	12	14	16		5	6	8	10	12	14	16	
08	20	0.57	45	38	28	23	19	16	14	23	19	14	11	9	8	7		15	13	9	8	6	5	5		
	30	0.69	55	46	34	27	23	20	17	27	23	17	14	11	10	9		18	15	11	9	8	7	6		
	40	0.80	63	53	40	32	26	23	20	32	26	20	16	13	11	10		21	18	13	11	9	8	7		
	50	0.89	70	59	44	35	29	25	22	35	29	22	18	15	13	11		23	20	15	12	10	8	7		
	60	0.98	78	65	49	39	32	28	24	39	32	24	19	16	14	12		26	22	16	13	11	9	8		
	70	1.06	84	70	52	42	35	30	26	42	35	26	21	17	15	13		28	23	17	14	12	10	9		
	80	1.13	89	75	56	45	37	32	28	45	37	28	22	19	16	14		30	25	19	15	12	11	9		
10	20	0.71	56	47	35	28	23	20	18	28	23	18	14	12	10	9		19	16	12	9	8	7	6		
	30	0.87	69	57	43	34	29	25	22	34	29	22	17	14	12	11		23	19	14	11	10	8	7		
	40	1.00	79	66	50	40	33	28	25	40	33	25	20	17	14	12		26	22	17	13	11	9	8		
	50	1.12	89	74	55	44	37	32	28	44	37	28	22	18	16	14		30	25	18	15	12	11	9		
	60	1.22	97	81	60	48	40	35	30	48	40	30	24	20	17	15		32	27	20	16	13	12	10		
	70	1.32	105	87	65	52	44	37	33	52	44	33	26	22	19	16		35	29	22	17	15	12	11		
	80	1.41	112	93	70	56	47	40	35	56	47	35	28	23	20	17		37	31	23	19	16	13	12		
15	20	1.06	84	70	52	42	35	30	26	42	35	26	21	17	15	13		28	23	17	14	12	10	9		
	30	1.30	103	86	64	51	43	37	32	51	43	32	26	21	18	16		34	29	21	17	14	12	11		
	40	1.50	119	99	74	59	50	42	37	59	50	37	30	25	21	19		40	33	25	20	17	14	12		
	50	1.68	133	111	83	67	55	48	42	67	55	42	33	28	24	21		44	37	28	22	18	16	14		
	60	1.84	146	121	91	73	61	52	46	73	61	46	36	30	26	23		49	40	30	24	20	17	15		
	70	2.0	158	132	99	79	66	57	50	79	66	50	40	33	28	25		53	44	33	26	22	19	17		
	80	2.1	166	139	104	83	69	59	52	83	69	52	42	35	30	26		55	46	35	28	23	20	17		
20	20	1.41	112	93	70	56	47	40	35	56	47	35	28	23	20	17		37	31	23	19	16	13	12		
	30	1.73	137	114	86	69	57	49	43	69	57	43	34	29	24	21		46	38	29	23	19	16	14		
	40	2.0	158	132	99	79	66	57	50	79	66	50	40	33	28	25		53	44	33	26	22	19	17		
	50	2.2	174	145	109	87	73	62	54	87	73	54	44	36	31	27		58	48	36	29	24	21	18		
	60	2.4	190	158	119	95	79	68	59	95	79	59	48	40	34	30		63	53	40	32	26	23	20		
	70	2.6	206	172	129	103	86	74	64	103	86	64	51	43	37	32		69	57	43	34	29	25	21		
	80	2.8	222	185	139	111	92	79	69	111	92	69	55	46	40	35		74	62	46	37	31	26	23		
30	20	2.1	166	139	104	83	69	59	52	83	69	52	42	35	30	26		55	46	35	28	23	20	17		
	30	2.6	206	172	129	103	86	74	64	103	86	64	51	43	37	32		69	57	43	34	29	25	21		
	40	3.0	238	198	149	119	99	85	74	119	99	74	59	50	42	37		79	66	50	40	33	28	25		
	50	3.4	269	224	168	135	112	96	84	135	112	84	67	56	48	42		90	75	56	45	37	32	28		
	60	3.7	293	244	183	147	122	105	92	147	122	92	73	61	52	46		98	81	61	49	41	35	31		
	70	4.0	317	264	198	158	132	113	99	158	132	99	79	66	57	50		106	88	66	53	44	38	33		
	80	4.2	333	277	208	166	139	119	104	166	139	104	83	69	59	52		111	92	69	55	46	40	35		
40	20	2.8	222	185	139	111	92	79	69	111	92	69	55	46	40	35		74	62	46	37	31	26	23		
	30	3.5	277	231	173	139	116	99	87	139	116	87	69	58	50	43		92	77	58	46	39	33	29		
	40	4.0	317	264	198	158	132	113	99	158	132	99	79	66	57	50		106	88	66	53	44	38	33		
	50	4.5	356	297	223	178	149	127	111	178	149	111	89	74	64	56		119	99	74	59	50	42	37		
	60	4.9	388	323	243	194	162	139	121	194	162	121	97	81	69	61		129	108	81	65	54	46	40		
	70	5.3	420	350	262	210	175	150	131	210	175	131	105	87	75	66		140	117	87	70	58	50	44		
	80	5.7	451	376	282	226	188	161	141	226	188	141	113	94	81	71		150	125	94	75	63	54	47		
50	20	3.5	277	231	173	139	116	99	87	139	116	87	69	58	50	43		92	77	58	46	39	33	29		
	30	4.3	341	284	213	170	142	122	106	170	142	106	85	71	61	53		114	95	71	57	47	41	35		
	40	5.0	396	330	248	198	165	141	124	198	165	124	99	83	71	62		132	110	83	66	55	47	41		
	50	5.6	444	370	277	222	185	158	139	222	185	139	111	92	79	69		148	123	92	74	62	53	46		
	60	6.1	483	403	302	242	201	173	151	242	201	151	121	101	86	75		161	134	101	81	67	58	50		
	70	6.6	523	436	327	261	218	187	163	261	218	163	131	109	93	82		174	145	109	87	73	62	54		
	80	7.1	562	469	351	281	234	201	176	281	234	176	141	117	100	88		187	156	117	94	78	67	59		
60	20	4.2	333	277	208	166	139	119	104	166	139	104	83	69	59	52		111	92	69	55	46	40	35		
	30	5.2	412	343	257	206	172	147	129	206	172	129	103	86	74	64		137	114	86	69	57	49	43		
	40	6.0	475	396	297	238	198	170	149	238	198	149	119	99	85	74		158	132	99	79	66	57	50		
	50	6.7	531	442	332	265	221	190	166	265	221	166	133	111	95	83		177	147	111	88	74	63	55		
	60	7.3	578	482	361	289	241	206	181	289	241	181	145	120	103	90		193	161	120	96	80	69	60		
	70	7.9	626	521	391	313	261	223	196	313	261	196	156	130	112	98		209	174	130	104	87	74	65		
	80	8.5	673	561	421	337	281	240	210	337	281	210	168	140	120	105		224	187	140	112	94	80	70		

# Broadcast Application Chart-50 cm Spacing

Nozzle Size	Pressure (BAR)	Flow Rate (L/min)	L/ha 50cm Nozzle Spacing									
			km/H									
			6	8	10	12	14	16	18	20	25	30
01	1	0.23	46	35	28	23	20	17	15	14	11	9
	2	0.33	66	50	40	33	28	25	22	20	16	13
	3	0.40	80	60	48	40	34	30	27	24	19	16
	4	0.46	92	69	55	46	39	35	31	28	22	18
	5	0.52	104	78	62	52	45	39	35	31	25	21
	6	0.57	114	86	68	57	49	43	38	34	27	23
	7	0.61	122	92	73	61	52	46	41	37	29	24
	8	0.65	130	98	78	65	56	49	43	39	31	26
015	1	0.35	70	53	42	35	30	26	23	21	17	14
	2	0.49	98	74	59	49	42	37	33	29	24	20
	3	0.60	120	90	72	60	51	45	40	36	29	24
	4	0.69	138	104	83	69	59	52	46	41	33	28
	5	0.77	154	116	92	77	66	58	51	46	37	31
	6	0.85	170	128	102	85	73	64	57	51	41	34
	7	0.92	184	138	110	92	79	69	61	55	44	37
	8	0.98	196	147	118	98	84	74	65	59	47	39
02	1	0.46	92	69	55	46	39	35	31	28	22	18
	2	0.65	130	98	78	65	56	49	43	39	31	26
	3	0.80	160	120	96	80	69	60	53	48	38	32
	4	0.92	184	138	110	92	79	69	61	55	44	37
	5	1.03	206	155	124	103	88	77	69	62	49	41
	6	1.13	226	170	136	113	97	85	75	68	54	45
	7	1.22	244	183	146	122	105	92	81	73	59	49
	8	1.31	262	197	157	131	112	98	87	79	63	52
025	1	0.58	116	87	70	58	50	44	39	35	28	23
	2	0.82	164	123	98	82	70	62	55	49	39	33
	3	1.00	200	150	120	100	86	75	67	60	48	40
	4	1.15	230	173	138	115	99	86	77	69	55	46
	5	1.29	258	194	155	129	111	97	86	77	62	52
	6	1.41	282	212	169	141	121	106	94	85	68	56
	7	1.53	306	230	184	153	131	115	102	92	73	61
	8	1.63	326	245	196	163	140	122	109	98	78	65
03	1	0.69	138	104	83	69	59	52	46	41	33	28
	2	0.98	196	147	118	98	84	74	65	59	47	39
	3	1.20	240	180	144	120	103	90	80	72	58	48
	4	1.39	278	209	167	139	119	104	93	83	67	56
	5	1.55	310	233	186	155	133	116	103	93	74	62
	6	1.70	340	255	204	170	146	128	113	102	82	68
	7	1.83	366	275	220	183	157	137	122	110	88	73
	8	1.96	392	294	235	196	168	147	131	118	94	78
035	1	0.81	162	122	97	81	69	61	54	49	39	32
	2	1.14	228	171	137	114	98	86	76	68	55	46
	3	1.40	280	210	168	140	120	105	93	84	67	56
	4	1.62	324	243	194	162	139	122	108	97	78	65
	5	1.81	362	272	217	181	155	136	121	109	87	72
	6	1.98	396	297	238	198	170	149	132	119	95	79
	7	2.14	428	321	257	214	183	161	143	128	103	86
	8	2.29	458	344	275	229	196	172	153	137	110	92
04	1	0.92	184	138	110	92	79	69	61	55	44	37
	2	1.31	262	197	157	131	112	98	87	79	63	52
	3	1.60	320	240	192	160	137	120	107	96	77	64
	4	1.85	370	278	222	185	159	139	123	111	89	74
	5	2.07	414	311	248	207	177	155	138	124	99	83
	6	2.26	452	339	271	226	194	170	151	136	108	90
	7	2.44	488	366	293	244	209	183	163	146	117	98
	8	2.61	522	392	313	261	224	196	174	157	125	104
05	1	1.15	230	173	138	115	99	86	77	69	55	46
	2	1.63	326	245	196	163	140	122	109	98	78	65
	3	2.00	400	300	240	200	171	150	133	120	96	80
	4	2.31	462	347	277	231	198	173	154	139	111	92
	5	2.58	516	387	310	258	221	194	172	155	124	103
	6	2.83	566	425	340	283	243	212	189	170	136	113
	7	3.06	612	459	367	306	262	230	204	184	147	122
	8	3.27	654	491	392	327	280	245	218	196	157	131
06	1	1.39	278	209	167	139	119	104	93	83	67	56
	2	1.96	392	294	235	196	168	147	131	118	94	78
	3	2.40	480	360	288	240	206	180	160	144	115	96
	4	2.77	554	416	332	277	237	208	185	166	133	111
	5	3.10	620	465	372	310	266	233	207	186	149	124
	6	3.39	678	509	407	339	291	254	226	203	163	136
	7	3.67	734	551	440	367	315	275	245	220	176	147
	8	3.92	784	588	470	392	336	294	261	235	188	157
08	1	1.85	370	278	222	185	159	139	123	111	89	74
	2	2.61	522	392	313	261	224	196	174	157	125	104
	3	3.20	640	480	384	320	274	240	213	192	154	128
	4	3.70	740	555	444	370	317	278	247	222	178	148
	5	4.13	826	620	496	413	354	310	275	248	198	165
	6	4.53	906	680	544	453	388	340	302	272	217	181
	7	4.89	978	734	587	489	419	367	326	293	235	196
	8	5.23	1046	785	628	523	448	392	349	314	251	209
10	1	2.31	462	347	277	231	198	173	154	139	111	92
	2	3.27	654	491	392	327	280	245	218	196	157	131
	3	4.00	800	600	480	400	343	300	267	240	192	160
	4	4.62	924	693	554	462	396	347	308	277	222	185
	5	5.16	1032	774	619	516	442	387	344	310	248	206
	6	5.66	1132	849	679	566	485	425	377	340	272	226
	7	6.11	1222	917	733	611	524	458	407	367	293	244
	8	6.53	1306	980	784	653	560	490	435	392	313	261

Rates for Nozzle sizes 15, 20, 30, 40, 50 and 60 are available: contact Tech Services at 800-445-8360.

# Hi-Flow Application Chart - 50cm, 100cm & 150cm Spacing

Nozzle Size	BAR	LPM	Application Rate (L/ha) 50 cm spacing									Application Rate (L/ha) 100 cm spacing								Application Rate (L/ha) 150 cm spacing							
			KPH									KPH								KPH							
			7	8	10	12	15	20	25	30	7	8	10	12	15	20	25	30	7	8	10	12	15	20	25	30	
08	1.5	2.26	387	339	271	226	181	136	108	90	194	170	136	113	90	68	54	45	129	113	90	75	60	45	36	30	
	2.0	2.61	447	392	313	261	209	157	125	104	224	196	157	131	104	78	63	52	149	131	104	87	70	52	42	35	
	2.5	2.92	501	438	350	292	234	175	140	117	250	219	175	146	117	88	70	58	167	146	117	97	78	58	47	39	
	3.0	3.20	549	480	384	320	256	192	154	128	274	240	192	160	128	96	77	64	183	160	128	107	85	64	51	43	
	4.0	3.70	634	555	444	370	296	222	178	148	317	278	222	185	148	111	89	74	211	185	148	123	99	74	59	49	
	5.0	4.00	686	600	480	400	320	240	192	160	343	300	240	200	160	120	96	80	229	200	160	133	107	80	64	53	
	6.0	4.53	777	680	544	453	362	272	217	181	388	340	272	227	181	136	109	91	259	227	181	151	121	91	72	60	
10	1.5	2.80	480	420	336	280	224	168	134	112	240	210	168	140	112	84	67	56	160	140	112	93	75	56	45	37	
	2.0	3.30	566	495	396	330	264	198	158	132	283	248	198	165	132	99	79	66	189	165	132	110	88	66	53	44	
	2.5	3.70	634	555	444	370	296	222	178	148	317	278	222	185	148	111	89	74	211	185	148	123	99	74	59	49	
	3.0	4.00	686	600	480	400	320	240	192	160	343	300	240	200	160	120	96	80	229	200	160	133	107	80	64	53	
	4.0	4.60	789	690	552	460	368	276	221	184	394	345	276	230	184	138	110	92	263	230	184	153	123	92	74	61	
	5.0	5.20	891	780	624	520	416	312	250	208	446	390	312	260	208	156	125	104	297	260	208	173	139	104	83	69	
	6.0	5.70	977	855	684	570	456	342	274	228	489	428	342	285	228	171	137	114	326	285	228	190	152	114	91	76	
15	1.5	4.20	720	630	504	420	336	252	202	168	360	315	252	210	168	126	101	84	240	210	168	140	112	84	67	56	
	2.0	4.90	840	735	588	490	392	294	235	196	420	368	294	245	196	147	118	98	280	245	196	163	131	98	78	65	
	2.5	5.50	943	825	660	550	440	330	264	220	471	413	330	275	220	165	132	110	314	275	220	183	147	110	88	73	
	3.0	6.00	1029	900	720	600	480	360	288	240	514	450	360	300	240	180	144	120	343	300	240	200	160	120	96	80	
	4.0	6.90	1183	1035	828	690	552	414	331	276	591	518	414	345	276	207	166	138	394	345	276	230	184	138	110	92	
	5.0	7.7	1320	1155	924	770	616	462	370	308	660	578	462	385	308	231	185	154	440	385	308	257	205	154	123	103	
	6.0	8.5	1457	1275	1020	850	680	510	408	340	729	638	510	425	340	255	204	170	486	425	340	283	227	170	136	113	
20	1.5	5.70	977	855	684	570	456	342	274	228	489	428	342	285	228	171	137	114	326	285	228	190	152	114	91	76	
	2.0	6.50	1114	975	780	650	520	390	312	260	557	488	390	325	260	195	156	130	371	325	260	217	173	130	104	87	
	2.5	7.3	1251	1095	876	730	584	438	350	292	626	548	438	365	292	219	175	146	417	365	292	243	195	146	117	97	
	3.0	8.0	1371	1200	960	800	640	480	384	320	686	600	480	400	320	240	192	160	457	400	320	267	213	160	128	107	
	4.0	9.2	1577	1380	1104	920	736	552	442	368	789	690	552	460	368	276	221	184	526	460	368	307	245	184	147	123	
	5.0	10.3	1766	1545	1236	1030	824	618	494	412	883	773	618	515	412	309	247	206	589	515	412	343	275	206	165	137	
	6.0	11.3	1937	1695	1356	1130	904	678	542	452	969	848	678	565	452	339	271	226	646	565	452	377	301	226	181	151	
30	1.5	8.5	1457	1275	1020	850	680	510	408	340	729	638	510	425	340	255	204	170	486	425	340	283	227	170	136	113	
	2.0	9.8	1680	1470	1176	980	784	588	470	392	840	735	588	490	392	294	235	196	560	490	392	327	261	196	157	131	
	2.5	11.0	1886	1650	1320	1100	880	660	528	440	943	825	660	550	440	330	264	220	629	550	440	367	293	220	176	147	
	3.0	12.0	2057	1800	1440	1200	960	720	576	480	1029	900	720	600	480	360	288	240	686	600	480	400	320	240	192	160	
	4.0	13.9	2383	2085	1668	1390	1112	834	667	556	1191	1043	834	695	556	417	334	278	794	695	556	463	371	278	222	185	
	5.0	15.5	2657	2325	1860	1550	1240	930	744	620	1329	1163	930	775	620	465	372	310	886	775	620	517	413	310	248	207	
	6.0	17.0	2914	2550	2040	1700	1360	1020	816	680	1457	1275	1020	850	680	510	408	340	971	850	680	567	453	340	272	227	
40	1.5	11.3	1937	1695	1356	1130	904	678	542	452	969	848	678	565	452	339	271	226	646	565	452	377	301	226	181	151	
	2.0	13.1	2246	1965	1572	1310	1048	786	629	524	1123	983	786	655	524	393	314	262	749	655	524	437	349	262	210	175	
	2.5	14.6	2503	2190	1752	1460	1168	876	701	584	1251	1095	876	730	584	438	350	292	834	730	584	487	389	292	234	195	
	3.0	16.0	2743	2400	1920	1600	1280	960	768	640	1371	1200	960	800	640	480	384	320	914	800	640	533	427	320	256	213	
	4.0	18.5	3171	2775	2220	1850	1480	1110	888	740	1586	1388	1110	925	740	555	444	370	1057	925	740	617	493	370	296	247	
	5.0	20.7	3549	3105	2484	2070	1656	1242	994	828	1774	1553	1242	1035	828	621	497	414	1183	1035	828	690	552	414	331	276	
	6.0	22.6	3874	3390	2712	2260	1808	1356	1085	904	1937	1695	1356	1130	904	678	542	452	1291	1130	904	753	603	452	362	301	
50	1.5	14.1	2417	2115	1692	1410	1128	846	677	564	1209	1058	846	705	564	423	338	282	806	705	564	470	376	282	226	188	
	2.0	16.3	2794	2445	1956	1630	1304	978	782	652	1397	1223	978	815	652	489	391	326	931	815	652	543	435	326	261	217	
	2.5	18.3	3137	2745	2196	1830	1464	1098	878	732	1569	1373	1098	915	732	549	439	366	1046	915	732	610	488	366	293	244	
	3.0	20.0	3429	3000	2400	2000	1600	1200	960	800	1714	1500	1200	1000	800	600	480	400	1143	1000	800	667	533	400	320	267	
	4.0	23.1	3960	3465	2772	2310	1848	1386	1109	924	1980	1733	1386	1155	924	693	554	462	1320	1155	924	770	616	462	370	308	
	5.0	25.8	4423	3870	3096	2580	2064	1548	1238	1032	2211	1935	1548	1290	1032	774	619	516	1474	1290	1032	860	688	516	413	344	
	6.0	28.3	4851	4245	3396	2830	2264	1698	1358	1132	2426	2123	1698	1415	1132	849	679	566	1617	1415	1132	943	755	566	453	377	
60	1.5	17.0	2914	2550	2040	1700	1360	1020	816	680	1457	1275	1020	850	680	510	408	340	971	850	680	567	453	340	272	227	
	2.0	19.6	3360	2940	2352	1960	1568	1176	941	784	1680	1470	1176	980	784	588	470	392	1120	980	784	653	523	392	314	261	
	2.5	21.9	3754	3285	2628	2190	1752	1314	1051	876	1877	1643	1314	1095	876	657	526	438	1251	1095	876	730	584	438	350	292	
	3.0	24.0	4114	3600	2880	2400	1920	1440	1152	960	2057	1800	1440	1200	960	720	576	480	1371	1200	960</						

# Spacing, Height, & Conversion Tables

## Suggested Minimum Broadcast Spray Heights

(Flat Fan Spray Nozzles)

Spray Angle		15" (40 cm) Spacing	20" (50 cm) Spacing	30" (75 cm) Spacing	40" (100 cm) Spacing**
80 Degree	Standard	13"-14"	17"-19"	26"-28"	NR*
	Metric	33-36 cm	43-48 cm	66-71 cm	NR*
110 Degree	Standard	10"-11"	15"-18"	20"-22"	NR*
	Metric	25-28 cm	38-46 cm	51-56 cm	NR*
120 Degree	Standard	8"-10"	12"-15"	16"-20"	24"-30"
	Metric	20-25 cm	30-38 cm	41-52 cm	61-76 cm
140 Degree	Standard	5"-7"	7"-9"	10"-14"	14"-18"
	Metric	13-18 cm	18-23 cm	25-35 cm	35-45 cm

\* Not Recommended

\*\* 40" nozzle spacing is prone to off-target trespass under certain conditions that affect drift.

## Optimum Broadcast Spray Heights

(Flat Fan Spray Nozzles)

Spray Angle		15" (40 cm) Spacing	20" (50 cm) Spacing	30" (75 cm) Spacing	40" (100 cm) Spacing**
80 Degree	Standard	22"	30"	43"	NR*
	Metric	56 cm	76 cm	109 cm	NR*
110 Degree	Standard	15"	20"	30"	NR*
	Metric	38 cm	51 cm	76 cm	NR*
120 Degree	Standard	13"	18"	28"	38"
	Metric	33 cm	46 cm	71cm	97cm
140 Degree	Standard	10"	12"	16"	22"
	Metric	25 cm	30 cm	40 cm	55 cm

## Nozzle Spacing

If your nozzle spacing differs from the spacing used in spray nozzle application rate tables, multiply the tabulated GPA by the conversion factor to find your actual application rate.

Example: If your nozzle spacing is actually 36-inches (90cm), your application rate will be 0.56 times what is shown in tables for nozzles spaced 20-inches (50cm).

To calculate a conversion factor for spacing not listed below, use the following formula:

$$\text{Standard Conversion Factor} = \frac{\text{Nozzle Spacing in Table (inches)}}{\text{Your Nozzle Spacing (inches)}}$$

$$\text{Metric Conversion Factor} = \frac{\text{Nozzle Spacing in Table (cm)}}{\text{Your Nozzle Spacing (cm)}}$$

### Standard U.S.

Your Spacing	Conversion from Charts		
	20 in	30 in	40 in
8 in	2.50	3.75	5.00
10 in	2.00	3.00	4.00
12 in	1.67	2.50	3.33
14 in	1.43	2.14	2.86
15 in	1.33	2.00	2.67
16 in	1.25	1.88	2.50
18 in	1.11	1.67	2.22
20 in	1.00	1.50	2.00
22 in	0.91	1.36	1.82
24 in	0.83	1.25	1.67
26 in	0.77	1.15	1.54
28 in	0.71	1.07	1.43
30 in	0.67	1.00	1.33
32 in	0.63	0.94	1.25
34 in	0.59	0.88	1.18
36 in	0.56	0.83	1.11
38 in	0.53	0.79	1.05
40 in	0.50	0.75	1.00
42 in	0.48	0.71	0.95
44 in	0.45	0.68	0.91
48 in	0.42	0.63	0.83

### Metric

Your Spacing	Conversion from Charts		
	50 cm	75 cm	100 cm
10 cm	5.00	7.50	10.00
15 cm	3.33	5.00	6.67
20 cm	2.50	3.75	5.00
25 cm	2.00	3.00	4.00
30 cm	1.67	2.50	3.33
33 cm	1.52	2.27	3.03
40 cm	1.25	1.88	2.50
45 cm	1.11	1.67	2.22
50 cm	1.00	1.50	2.00
55 cm	0.91	1.36	1.82
60 cm	0.83	1.25	1.67
65 cm	0.77	1.15	1.54
70 cm	0.71	1.07	1.43
75 cm	0.67	1.00	1.33
80 cm	0.63	0.94	1.25
85 cm	0.59	0.88	1.18
90 cm	0.56	0.83	1.11
95 cm	0.53	0.79	1.05
100 cm	0.50	0.75	1.00
110 cm	0.45	0.68	0.91
120 cm	0.42	0.63	0.83

# Spraying Solutions other than Water

Liquids that are more dense than water will flow through a spray nozzle more slowly than water. Solutions that are less dense than water will flow through a spray nozzle more quickly than water. Unless otherwise indicated, the performance tables in the spray nozzle section of this catalog show flow and application rates for water-based sprays. To use those tables when selecting nozzles to apply non-water sprays you must calculate an intermediate "look-up" application rate. To do this you will multiply your actual desired application rate by a conversion factor and then use the resulting "look-up" figure to select a nozzle from the water-based performance tables. The conversion factors listed on this page are based on typical values for common fertilizer solutions. For other spray solutions, you can calculate the conversion factor by taking the square root of the solution's specific gravity.

For easier nozzle selection using water and non-water sprays, use the SprayIT calculator online at: <http://SprayIT.hypropumps.com>.

## U.S. Units

Density (lb/us gal)	Material	Specific Gravity	Conversion Factor
7.00		0.84	0.92
8.00		0.96	0.98
8.34	water	1.00	1.00
9.00		1.08	1.04
10.00		1.20	1.10
10.30	4-10-10	1.24	1.11
10.65	28-0-0	1.28	1.13
11.00		1.32	1.15
11.05	32-0-0	1.32	1.15
11.20	7-21-7	1.34	1.16
11.65	10-34-0	1.40	1.18
12.00		1.44	1.20

### Example:

Your desired application rate of 28% Nitrogen fertilizer (28-0-0) is 30 US GPA.

Multiply 30 GPA by Conversion Factor 1.13 to find the converted look-up application rate of 33.9 GPA.

Select a spray nozzle that will apply 33.9 GPA of water-based spray. A spray nozzle that will apply 33.9 GPA of water will apply 30 GPA of 28-0-0 fertilizer solution.

## Metric

Density (kg/L)	Material	Conversion Factor
0.80		0.89
0.90		0.95
1.00	water	1.00
1.10		1.05
1.20		1.10
1.24	4-10-10	1.11
1.28	28-0-0	1.13
1.30		1.14
1.32	32-0-0	1.15
1.34	7-21-7	1.16
1.40	10-34-0	1.18
1.50		1.22

### Example:

Your desired application rate of 28% Nitrogen fertilizer (28-0-0) is 300 L/ha.

Multiply 300 L/ha X Conversion Factor 1.13 to find the converted look-up application rate of 339 L/ha.

Select a spray nozzle that will apply 339 L/ha of water-based spray. A spray nozzle that will apply 339 L/ha of water will apply 300 L/ha of 28-0-0 fertilizer solution.

# Broadcast Application Formulas

## US Standard

Application Formulas – US Standard

GPM – Gallons per minute (per spray nozzle)

GPA – Gallons per acre

GAL/1000FT<sup>2</sup> – Gallons per 1000 square feet

MPH – Miles per hour

W – Nozzle spacing (inches) for broadcast spraying

- Spray width (inches) for single-nozzle band

spraying or boomless spraying

- Row spacing (inches) divided by the number of nozzles per row for directed spraying

$$\text{GPM} = \frac{\text{GPA} \times \text{MPH} \times \text{W}}{5,940}$$

$$\text{GPM} = \frac{\text{GAL}/1000\text{FT}^2 \times \text{MPH} \times \text{W}}{136}$$

$$\text{GPA} = \frac{5,940 \times \text{GPM}}{\text{MPH} \times \text{W}}$$

$$\text{GAL}/1000\text{FT}^2 = \frac{136 \times \text{GPM}}{\text{MPH} \times \text{W}}$$

## Metric

Application Formulas – Metric

LPM – Litres per minute (per spray nozzle)

L/ha – Litres per hectare

Kmph – Kilometres per hour

W – Nozzle spacing (m) for broadcast spraying

- Spray width (m) for single-nozzle band spraying

or boomless spraying

- Row spacing (m) divided by the number of nozzles per row for directed spraying

$$\text{LPM} = \frac{\text{L}/\text{ha} \times \text{Kmph} \times \text{W}}{600}$$

$$\text{L}/\text{ha} = \frac{600 \times \text{LPM}}{\text{Kmph} \times \text{W}}$$

# Band Spraying Application Formulas

## US Standard

$$\text{Volume of Chemical Solution Required in Gallons} = \frac{\text{Band Width (inches)}}{[\text{Band Width} + \text{Spacing between Bands}] \text{ (inches)}}$$

$$\text{Label Rate of Carrier (GPA)} \times \text{Field Area (Acres)}$$

## Height Requirement – Band Spraying

Band Width	Height over Target 80°	Height over Target 110°
8"	5"	3"
10"	6"	4"
12"	7"	4"
15"	9"	5"
18"	11"	6"
20"	12"	7"
30"	18"	11"

To find GPA in the band, use the following equation:

$$\text{Band GPA} = \frac{5940 \times \text{GPM} \times \text{N}}{\text{MPH} \times \text{W}}$$

GPM needed per Nozzle:

$$\text{GPM} = \frac{\text{GPA} \times \text{MPH} \times \text{W}}{5940 \times \text{N}}$$

## Treated Area Per Field For Banding Applications

Row Spacing in Inches	Band Width						
	7"	8"	10"	12"	15"	20"	24"
20"	0.350	0.400	0.500	0.600	0.75	1.000	
22"	0.318	0.363	0.454	0.545	0.681	0.909	
30"	0.233	0.266	0.333	0.400	0.500	0.666	0.800
36"	0.194	0.222	0.278	0.333	0.416	0.555	0.666
40"	0.175	0.200	0.250	0.300	0.375	0.500	0.600
48"	0.145	0.166	0.208	0.250	0.321	0.417	0.500

GPA = Gallons per acre  
 GPM = Gallons per minute  
 MPH = Speed in miles per hour  
 W = Band width in inches  
 N = Number of nozzles spraying each band

## Metric

$$\text{Volume of Chemical Solution Required in Litres} = \frac{\text{Band Width (m)}}{[\text{Band Width} + \text{Spacing between Bands}] \text{ (m)}}$$

$$\text{Label Rate of Carrier (L/ha)} \times \text{Field Area (ha)}$$

## Height Requirement – Band Spraying

Band Width	Height over Target 80°	Height over Target 110°
20 cm	12 cm	7 cm
25 cm	15 cm	9 cm
30 cm	18 cm	11 cm
40 cm	24 cm	14 cm
45 cm	27 cm	16 cm
50 cm	30 cm	18 cm
75 cm	45 cm	26 cm

To find the L/ha in the band, use the following equation:

$$\text{Band L/ha} = \frac{600 \times \text{LPM} \times \text{N}}{\text{Kmph} \times \text{W}}$$

LPM needed per Nozzle:

$$\text{LPM} = \frac{\text{L/ha} \times \text{Kmph} \times \text{W}}{600 \times \text{N}}$$

## Treated Area Per Field For Banding Applications

Row Spacing in cm	Band Width						
	18 cm	20 cm	25 cm	30 cm	38 cm	50 cm	60 cm
50 cm	0.360	0.400	0.500	0.600	0.760	1.000	
60 cm	0.300	0.333	0.417	0.500	0.633	0.833	1.000
75 cm	0.240	0.267	0.333	0.400	0.507	0.667	0.800
90 cm	0.200	0.222	0.278	0.333	0.422	0.556	0.667
100 cm	0.180	0.200	0.250	0.300	0.380	0.500	0.600
120 cm	0.150	0.167	0.208	0.250	0.317	0.417	0.500

L/ha = Litres per hectare  
 LPM = Litres per minute  
 Kmph = Speed in kilometres per hour  
 W = Band width in metres  
 N = Number of nozzles spraying each band

# Wear and Chemical Compatibility

**Ceramic** – Highly resistant to abrasive and corrosive chemistry and provides superior wear resistance in abrasive applications and high pressures. Albus nozzle orifices are made of pink inserted ceramic, reinforced by special oxides, and specially designed by Saint-Gobain for spraying applications.

**Polyacetal** – Provides good resistance to most chemicals and superior wear resistance to most agricultural chemistry. Susceptible to strong mineral acids and a few organic solvents. Resistance to most alkalis is excellent. Organic solvents usually cause slight swelling without any other harmful effect.\*

**Polyvinylidene Fluoride (PVDF)** – Should be used with acid-based agricultural defoliation chemistry. Good resistance to wear.\* Resists many reagents and high temperatures (up to 300°F). Susceptible to high temperatures above water boiling (210°F) in combination with concentrated sulfuric and nitric acids. Preferred in industrial spraying applications.

**Stainless Steel** – Good resistance to chemicals and provides average wear resistance.

**Brass** – Average resistance to most chemistry and poor wear resistance. Susceptible to corrosion, especially with fertilizers.

Hypro's Technical/Application Department is available to answer chemical compatibility issues and assist in choosing the correct spray nozzle for your application. Call 1-800-445-8360 (US) or +44 1954 260097 (Europe).

\* A list of resistant reagents, acids and alkaline is available from the Hypro Technical/Application Department.

## Comparative Accelerated Wear Test

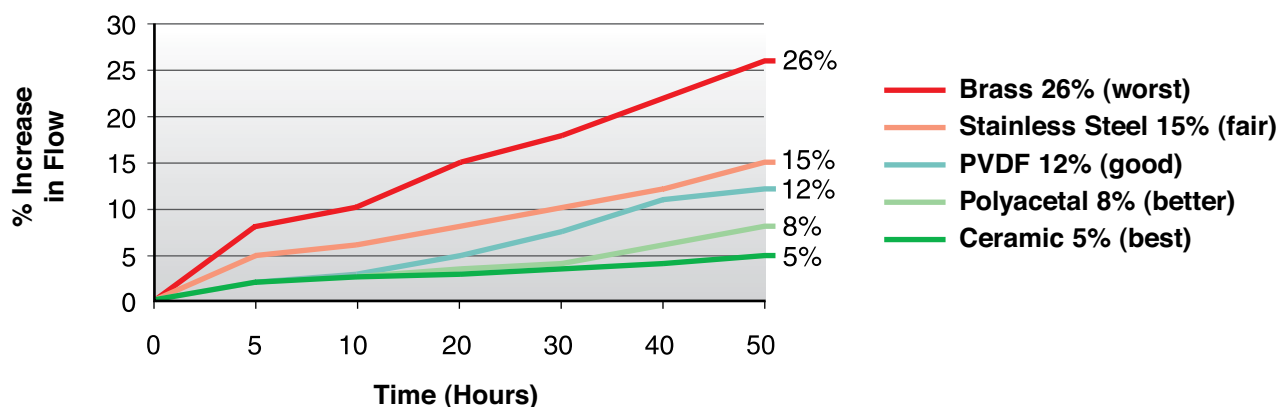

Source: SGS UK LTD. Saint-Gobain AC France  
 Test Medium: 2.5% Kaolin in water  
 Test Pressure: 40 psi

# Temperature Tolerance

Nozzle Material	Maximum Temperature	
PVC	58° C	136° F
Polyacetal	85° C	185° F
PVDF	150° C	302° F
Brass	234° C	453° F
Stainless Steel	430° C	806° F

# Spray Nozzle Maintenance and Information Guide

---

Spraying with a worn nozzle will have consequences for precision. Firstly, droplet size will be larger risking compromised spray coverage and uneven spray across the boom. If the sprayer is not fitted with a rate controller it will also mean uneven over application, this can be costly.

## Examples:

Just 10% increase in flow from worn nozzles represent a loss of \$2,000 to \$10,000 on a twice-sprayed 1,000 acre farm (based on \$10-\$50/acre chemical cost).

or

A 10% increase in flow rate would cost as much as €15/ha in on the average high yielding wheat crop, a loss of over €6,000 on a 400 hectare farm.

The good news is, monitoring and maintaining nozzle performance is one of the easiest ways to help keep a sprayer operating accurately and efficiently.

1. As a rule, replace nozzles worn (10% or more) or damaged at the beginning of each spraying season.
2. Only use the nozzle type that is recommended for your particular spraying application.
3. Calibrate your sprayer regularly to compensate for normal nozzle wear.
4. Monitor spray performance to catch worn, damaged, or plugged nozzles.

Hypro spray nozzles are precision-engineered components that should be regularly maintained to ensure that they give trouble-free service. To clear blocked nozzles, soak in water and clean with a brush and airline. For stubborn deposits, soak in warm water and detergent, agitating occasionally. Never blow through a nozzle or poke with wires or pins – damage to the orifice will alter flow rate, spray angle, and spray distribution.

## Factors Affecting Spray Nozzle Performance

---

The information in the chart below applies to most spray applications. However, because there are so many different types and sizes of spray nozzles, the effects may vary in a specific application. Hypro is glad to assist you with any specific application questions.

Increase In	Operating Pressure	Specific Gravity	Viscosity	Fluid Temperature	Surface Tension
Capacity (Flow Rate)	Increases	Decreases	•	• •	No Effect
Spray Angle	Increases then Decreases	Negligible	Decreases	Increases	Decreases
Droplet Size	Decreases	Negligible	Increases	Decreases	Increases
Pattern Quality	Improves	Negligible	Deteriorates	Improves	Negligible
Wear	Increases	Negligible	Decreases	Increases	--
Impact	Increases	Decreases	Decreases	Increases	Negligible
Velocity	Increases	Decreases	Decreases	Increases	Negligible

- Full cone and hollow cone increases, flat fan spray decreases
- • Depends on fluid being sprayed and spray nozzle used



# Accessories

---

<b>ProStop-E and Fence Row Control .....</b>	<b>Page 216</b>
<b>Express Boom Assembly .....</b>	<b>Page 218</b>
<b>Duo React.....</b>	<b>Page 220</b>
<b>ProFlo Nozzle Bodies and Accessories .....</b>	<b>Page 221</b>
<b>ProCap™ Tank Lids and Tank Accessories .....</b>	<b>Page 229</b>
<b>Cleanload™ Chemical Eductor.....</b>	<b>Page 234</b>
<b>Line Strainers .....</b>	<b>Page 236</b>
<b>Spray Guns .....</b>	<b>Page 238</b>
<b>Flowmeters .....</b>	<b>Page 243</b>
<b>Sprayer Control Valves .....</b>	<b>Page 244</b>
<b>Ball Valves .....</b>	<b>Page 248</b>
<b>Gauges .....</b>	<b>Page 249</b>
<b>Universal Flange Clamps, Gaskets and Fittings.....</b>	<b>Page 252</b>
<b>Fittings, Cable Ties, Hose Clamps &amp; Sealant .....</b>	<b>Page 254</b>

# ProStop-E

## Individual Nozzle Control for Precision Agriculture



- Control spray activation directly on Hypro ProFlo nozzle bodies
- Instantaneous on-off control with 12 volt actuation eliminates misapplication and waste
- Eliminates the need for centralized valve banks allowing on/off control at the nozzle body for individual or small section control
- Two actuation mode options:
  - Simple, 3-wire, 12 volt on/off actuation
  - Operate as an individually addressed valve on a CAN bus/ISO bus system
- Robust, quarter-turn electric ball valves are highly reliable as compared to solenoid and plunger valves
- Innovative locking collar mechanism allows for easy adjustments to valve orientation on the nozzle body
- Extremely low continuous power consumption
- High flow capacity in a compact valve design

### ProStop-E Valve



Part Number	Qty	Description
3305-0011	1	ProStop-E valve assembly fits all Hypro ProFlo nozzle bodies in place of the check valve.
4213-0504V	36	5-way ProFlo nozzle body with ProStop-E valve pre-assembled
PK-4223N-B524PSE	1	

ProStop-E Valve easily adapts directly to ProFlo single drop, 3-way/5-way and push-to-connect nozzle bodies in place of the traditional check valve. Valve and nozzle body must be ordered separately.



Part # 4213-0504V



Order valve and nozzle body separately to create these or other configurations for testing/development purposes.

### ProStop-E Cordsets



Part Number	Description
2520-0209	25" overmolded cordset with ultralock right angle connectors
2520-0210	25" overmolded cordset with threaded plastic right angle M12 connectors - Left Boom*
2520-0211	25" overmolded cordset with threaded plastic right angle M12 connectors - Right Boom*
2300-0067	Termination Plug
2520-0213	1 meter, threaded ends
2520-0214	2 meter, threaded ends
2520-0215	3 meter, threaded ends

Black-in; Grey-out, Other custom length cord sets available upon request.

\* Left and right boom are defined as the operator is sitting in the driver's seat of the equipment.



# Fence Row Control Box



## Features & Benefits of Control Box:

- Control one or two Hypro ProStop-E valves with easy on-off switch
- Allows for retrofit of sprayers for adding fence/end row control
- Simple M12 wiring to battery and valves for plug and play
- Easy to mount bracket provided
- Cable options for up to 120" boom length
- LED light indicator on each switch

Control Box	Description	Connection	Amp Rating
2850-0027	End Row Switch Box	Male 3-pin for Battery, Female 4-pin for Control	4A

Cable Part Numbers:	Description	Connection	Amp Rating
2520-0218	7M (23 ft) backbone cable	Threaded, M12 A-code by M12 A-Code	4A
2520-0217	Single end row control 27M (88.5 ft) cable	Threaded, Male 4-pin M12 by female 4-pin M12	4A
2520-0219	Y-cable with two 20M (65 ft) segments	Threaded, Male 4-pin by two Female 3-pin M12 A-Code	4A
2520-0216	7M (23 ft) battery cable	Threaded, Female 3-pin A-Code by flying leads	4A

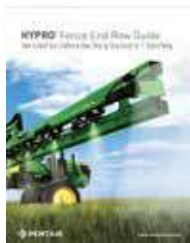
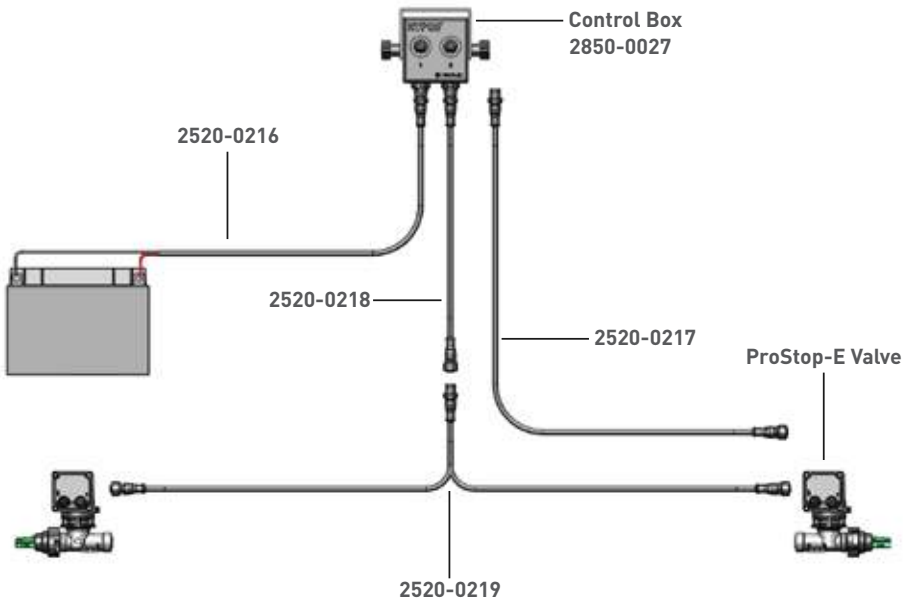

## Step-by-Step Guide:

See Hypro's Step-by-Step Guide to build your End/Fence Row Kit.

[www.hyprospraytips.com/stepbystep](http://www.hyprospraytips.com/stepbystep)

# Express Boom Assembly

## Modular Boom Sections



### Express End Cap Benefits

- Eliminates trapped air from the boom by allowing air to escape through the nozzle body, reducing nozzle turn-off time by 85%
- Eliminates "dead-ends" of pipe where chemical residue can build-up
- Cleanout port for easy boom flushing
- Creates a cleaner looking plumbing system by eliminating the need for an extra fitting at the end of the boom

### Express Boom Assembly Benefits

- Convert 20" nozzle spacing to 15" or 15" to 20"
- Easily convert your boom from polypropylene to stainless steel
- Greatly reduces assembly time
- Tested as a complete assembly to eliminate any potential assembly defects
- Single and bulk pack options that allow for standard shipping methods (i.e. FedEx®, UPS®, etc.)
- Improve sprayer performance with Express fittings and optimized design

### Boom Configuration Instructions:

1	<p>Complete boom assembly configuration sheet (visit <a href="http://www.hypropumps.com/express">www.hypropumps.com/express</a> for configuration worksheet).          Note sprayer model, number of sections, desired spacing's and boom length.          Walk boom from left breakaway to right* (Note all feeds, section controls, breakaways, etc.). If you run into configurations larger than 6 nozzle bodies with 15" spacing or 5 nozzle bodies with 20" spacing, break section into two to fit express boom system.          If you have any questions, please contact your local Hypro representative or Hypro technical team.</p> <p>*When converting from 20" to 15" its suggested to start at center of boom and work left. Mark each 15" and note all feeds. Then begin Step 1.</p>
2	<p>Review 'Quote' tab on configuration worksheet. Re-evaluate boom configuration to insure proper assembly.          Look specifically at where the tee fitting will be plumbed to the feed line. If there are interference issues with the boom structure look at alternative horizontal fittings that allow feed lines to mate up to express boom.</p>
3	<p>Print 'Quote' sheet and submit to your local Hypro sales representative or email to <a href="mailto:hypro.sales@pentair.com">hypro.sales@pentair.com</a> for pricing and availability.</p>

**Hypro Quote Review:** Hypro will review boom assembly quote sheet submitted. If local dealer is not listed on sheet, Hypro will contact you for final ordering procedures.

### Example Configuration w/15" Spacing:



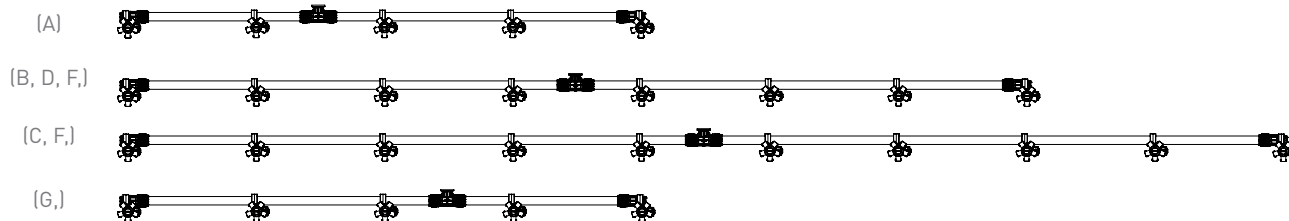







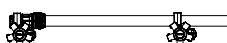

Section	Section 1		Section 2	Section 3	Section 4	Section 5	
Sequence	A	B	C	D	E	F	G
Boom Pipe Part Number	2410-0055	2410-0068	2410-0075	2410-0068	2410-0075	2410-0068	2410-0060
Configuration	2X3	4X4	5X5	4X4	5X5	4X4	3X2

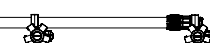
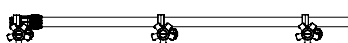

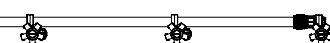
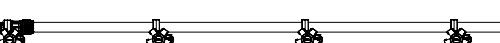
# Express Boom Assembly

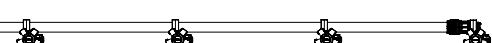
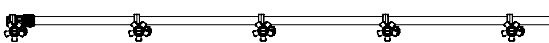
## Modular Boom Sections

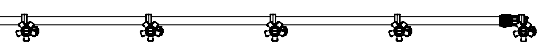
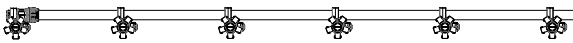
Hypro's Express Boom Assembly allows you to **CUSTOMIZE** each boom section by choosing the quantity of nozzle bodies either left or right of the tee for each section. Express Boom Assembly has the **FLEXIBILITY** to meet any boom design. These single section **CUSTOM** configurations can range from one nozzle body on the left and/or right branch, to six (15" spacing's) nozzle bodies on each branch. Review the chart below for all configuration options.

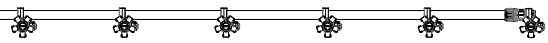
	Choose Left Branch	Tee	Choose Right Branch	
1				1
2				2
3				3
4				4
5				5
6*				6*

\* Only available in 15" spacings.

### Product Configurations

Configuration	15" Spacing Part Number	20" Spacing Part Number
1X1	2410-0047	2410-0021
1X2	2410-0048	2410-0022
1X3	2410-0049	2410-0023
1X4	2410-0050	2410-0024
1X5	2410-0051	2410-0025
1X6	2410-0052	-
2X1	2410-0053	2410-0026
2X2	2410-0054	2410-0027
2X3	2410-0055	2410-0028
2X4	2410-0056	2410-0029
2X5	2410-0057	2410-0030
2X6	2410-0058	-
3X1	2410-0059	2410-0031
3X2	2410-0060	2410-0032
3X3	2410-0061	2410-0033
3X4	2410-0062	2410-0034
3X5	2410-0063	2410-0035
3X6	2410-0064	-
4X1	2410-0065	2410-0036
4X2	2410-0066	2410-0037
4X3	2410-0067	2410-0038
4X4	2410-0068	2410-0039
4X5	2410-0069	2410-0040
4X6	2410-0070	-

Configuration	15" Spacing Part Number	20" Spacing Part Number
5X1	2410-0071	2410-0041
5X2	2410-0072	2410-0042
5X3	2410-0073	2410-0043
5X4	2410-0074	2410-0044
5X5	2410-0075	2410-0045
5X6	2410-0076	-
6X1	2410-0077	-
6X2	2410-0078	-
6X3	2410-0079	-
6X4	2410-0080	-
6X5	2410-0081	-
6X6	2410-0082	-
1XHB	2410-0086	2410-0086
2XHB	2410-0087	2410-0091
3XHB	2410-0088	2410-0092
4XHB	2410-0097	2410-0093
5XHB	2410-0098	2410-0094
HBX1	2410-0083	2410-0083
HBX2	2410-0084	2410-0089
HBX3	2410-0085	2410-0090
HBX4	2410-0099	2410-0095
HBX5	2410-0100	2410-0096

# DUO REACT Nozzle Bodies

## Compact and Economical Twin Valve Nozzle Body

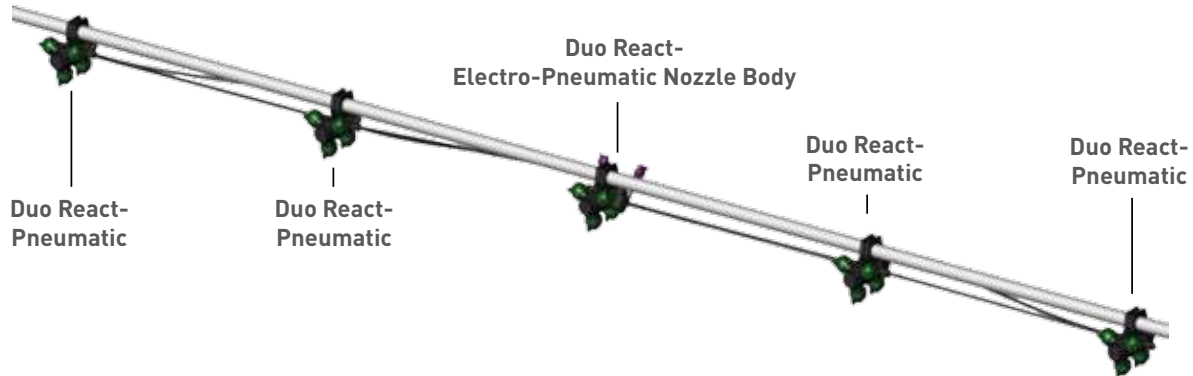

- A single and 4-way nozzle body incorporated into one compact unit
  - Eliminates the need for twin lines or “back to back” configurations
  - Simple operation, twin valves allow either or both nozzles to spray
- Allows the operator to select different nozzle combinations from the cab with a controller
- Compact design allows for easy integration into many boom designs
- Pneumatic only or electro-pneumatic actuated valve options
  - Electro-pneumatic body can be used in place of a section control valve to control up to 7 pneumatic Duo React nozzle bodies
- Available with hinged clamps 1/2”, 3/4”, 1”, 20mm and 25mm



### Duo React Electro-Pneumatic Twin Valve Nozzle Bodies for Wet Boom

Seal Options/ Housing Reference	(to clamp on) Pipe Size				
	1/2"	3/4"	1"	20 mm	25 mm
Viton®/Green	4214-2502V	4214-2503V	4214-2504V	4214-2507V	4214-2508V



### Duo React Pneumatic Twin Valve Nozzle Bodies for Wet Boom

Seal Options/ Housing Reference	(to clamp on) Pipe Size				
	1/2"	3/4"	1"	20 mm	25 mm
Viton®/Green	4214-1502V	4214-1503V	4214-1504V	4214-1507V	4214-1508V

### Duo React Spare Parts and Tool

Part Number	Description
3430-0840V	O-ring and piston sub-assembly kit
3021-0006	Cap removal service wrench

# PROFLO Nozzle Bodies

## Nozzle Bodies with the Highest Flow Rates in the Industry



### BENEFITS

- Designed to deliver the highest flow rates across the spraying pressure range
  - Unique DCV (diaphragm check valve) design reduces restrictions in the flow path, enabling 2.6 gpm (9.8 lpm) with a 5 psi (0.34 bar) pressure drop through the nozzle
  - Supports faster field speeds with the same coverage and supports direct fertilizer application through the nozzle body DCV flow path
- Turret-indexing design provides improved consistency and reliability throughout the life of the nozzle body – eliminating free spinning and seizing problems seen on competitive nozzle bodies
- Bayonet style attachment allows for automatic spray alignment using flat fan spray nozzles
- Compact design makes mounting easier with less potential interference with the spray boom structure
- ProFlo nozzle bodies come standard with an 8 psi (.55 bar) diaphragm check valve. 4 psi (.27 bar), 12 psi (.82 bar), 20 psi (1.37 bar), and 25 psi (1.72 bar) checks are available as options

### FEATURES

- Three turret styles for an easy change of spray nozzles: single, 3-way, and 5-way
- Provides lowest pressure drop at any given flow in the industry
- 2.6 gpm (9.84 LPM) with a 5 psi (.345 BAR) pressure drop
- Available in wet or dry boom versions
- Positive shutoff between each spray position
- Custom logos available upon request (minimum quantities apply)

ProFlo Nozzle Body Performance Curve

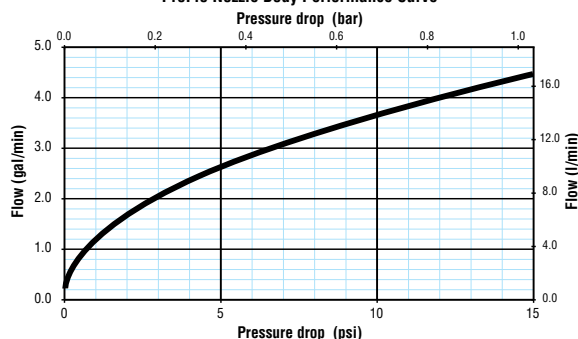

### 3 and 5-Way Nozzle Bodies for Wet Boom (no tab for boom clamp)



Seal Option/ Housing Reference	Turret Options	(to clamp on) Pipe Size				
		1/2"	3/4"	1"	20mm	25mm
EPDM/Red	3	4223N-B322	4223N-B323	4223N-B324	4223N-B327	4223N-B328
	5	4223N-B522	4223N-B523	4223N-B524	4223N-B527	4223N-B528
Viton®/Green	3	4223N-B322V	4223N-B323V	4223N-B324V	4223N-B327V	4223N-B328V
	5	4223N-B522V	4223N-B523V	4223N-B524V	4223N-B527V	4223N-B528V

Sold in Quantities of 100; Sold as single units through HYPRO-EU only (Cambridge,UK)  
 For Individual Bags, Add Suffix -00 [i.e.: 4223N-B322-00]  
 ProStop Valve in place of DCV - Add suffix "PS" [i.e. 4223N-B322PS]

### Triple Nozzle Bodies for Wet Boom



Seal Option/ Housing Reference	Part Number	Description
EPDM/Red	4222N-B322	1/2" split clamp
	4222N-B323	3/4" split clamp
	4222N-B324	1" split clamp

### Single Drop Nozzle Body for Wet Boom



Seal Option/ Housing Reference	(to clamp on) Pipe Size				
	1/2"	3/4"	1"	20mm	25mm
EPDM/Red	4221N-B122	4221N-B123	4221N-B124	4221N-B127	4221N-B128
Viton®/Green	4221N-B122V	4221N-B123V	4221N-B124V	4221N-B127V	4221N-B128V

Acid resistant polypropylene available with 1" clamp and EPDM Seal. part number: 402265P  
 1/4" FNPT Outlet- Substitute B with F [i.e.: 4221N-F122]  
 Sold in Quantities of 300; Sold as single units through HYPRO-EU only (Cambridge,UK)  
 For Individual Bags, Add Suffix -00 [i.e.: 4221N-B122-00]  
 ProStop Valve in place of DCV - Add suffix "PS" [i.e. 4221N-B122PS]

# PROFLO Nozzle Bodies



## 3 & 5-way Nozzle Bodies with Tab for Boom Clamp

Seal Option/ Housing Reference	Turret Options	(to clamp on) Pipe Size				
		1/2"	3/4"	1"	20mm	25mm
EPDM/Red	3	4243N-B322	4243N-B323	4243N-B324	4243N-B327	4243N-B328
	5	4243N-B522	4243N-B523	4243N-B524	4243N-B527	4243N-B528
Viton@/Green	3	4243N-B322V	4243N-B323V	4243N-B324V	4243N-B327V	4243N-B328V
	5	4243N-B522V	4243N-B523V	4243N-B524V	4243N-B527V	4243N-B528V

Sold in Quantities of 100; Sold as single units through HYPRO-EU only [Cambridge,UK]

For Individual Bags, Add Suffix -00 (i.e.: 4243N-B322-00).

ProStop Valve in place of DCV - Add suffix "PS" (ie. 4243N-B322PS)



## 3 & 5-way Nozzle Bodies with Tab for Boom Clamp and Hose Barb for Dry Boom

Seal Option/ Housing Reference	Turret Options	3/4" (19 mm)	3/4" (19 mm)	1" (25 mm)	1" (25 mm)
		Single Ended HB	Double Ended HB	Single Ended HB	Double Ended HB
EPDM/Red	3	4263N-B323S	4263N-B323D	4263N-B324S	4263N-B324D
	5	4263N-B523S	4263N-B523D	4263N-B524S	4263N-B524D
Viton@/Green	3	4263N-B323SV	4263N-B323DV	4263N-B324SV	4263N-B324DV
	5	4263N-B523SV	4263N-B523DV	4263N-B524SV	4263N-B524DV

Sold in Quantities of 100.

For Individual Bags, Add Suffix -00 (i.e.: 4263N-B323S-00).

## Dry Boom Adapters for Wet Boom Nozzle Bodies

Part Number	Type	Clamp Size	Hose Barb	
			US Units	Metric Units
4200-0111N	Single	1/2" Pipe	1/2"	13 mm
4200-0112N	Single	3/4" Pipe	3/4"	19 mm
4200-0113N	Single	3/4" Pipe	1"	25 mm
4200-0114N	Single	1" Pipe	3/4"	19 mm
4200-0115N	Single	1" Pipe	1"	25 mm
4200-0211N	Double	1/2" Pipe	1/2"	13 mm
4200-0212N	Double	3/4" Pipe	3/4"	19 mm
4200-0213N	Double	3/4" Pipe	1"	25 mm
4200-0214N	Double	1" Pipe	3/4"	19 mm
4200-0215N	Double	1" Pipe	1"	25 mm



## Hose Barb Triple Nozzle Bodies-with DCV

Seal Options/ Housing Reference	Single hose barb P/N	Double hose barb P/N	Triple hose barb P/N	Hose ID	
				US Units	Metric Units
EPDM/Red	4242N-B322S	4242N-B322D	4242N-B322T	1/2"	13 mm
	4242N-B323S	4242N-B323D	4242N-B323T	3/4"	19 mm

4242N-B300-Provides 1/4" MNPT Inlet



## Hose Barb Dry Boom Nozzle Bodies-with DCV

Seal Options/ Housing Reference	Single hose barb P/N	Double hose barb P/N	Triple hose barb P/N	Hose ID	
				US Units	Metric Units
EPDM/Red	4241N-B121S	4241N-B121D	4241N-B121T	3/8"	10 mm
	4241N-B122S	4241N-B122D	4241N-B122T	1/2"	13 mm
	4241N-B123S	4241N-B123D	4241N-B123T	3/4"	19 mm

Add Prefix "BG-" for 1 part per retail bag.





# Nozzle Bodies



## Hose Barb Dry Boom Nozzle Bodies-with Top-Mounted DCV

Seal Options/ Housing Reference	Single hose barb P/N	Double hose barb P/N	Hose ID	
			US Units	Metric Units
EPDM/Red	4240N-B121S	4240N-B121D	3/8"	10 mm
	4240N-B122S	4240N-B122D	1/2"	13 mm
	4240N-B123S	4240N-B123D	3/4"	19 mm

Add Prefix "BG-" for 1 part per retail bag.



## Single Nozzle Bodies with DCV

Seal Options/ Housing Reference	1/4" MNPT x 1/4" FNPT			1/4" MNPT x Bayonet		11/16" UNF x Bayonet	3/8" (10 mm) HB x Bayonet
	4 PSI (.28 BAR)	8 PSI (.55 BAR)	25 PSI (1.72 BAR)	4 PSI (.28 BAR)	8 PSI (.55 BAR)	8 PSI (.55 BAR)	8 PSI (.55 BAR)
EPDM/Red	4240N-F110	4240N-F120	4240N-F150	4240N-B010	4240N-B020	4241N-B120U	QT14-1-NDC
Viton®/Green	4240N-F110V	4240N-F120V	4240N-F150V	4240N-B010V	4240N-B020V	-	-

## Push-to-Connect Nozzle Bodies



Type	Push-to-Connect (PTC) Nozzle Body Part Numbers				
	DCV	4 PSI (.28 BAR)		8PSI (.55 BAR)	
	Size	25 Std. Pack	1 Per Bag	25 Std. Pack	1 Per Bag
PTC to Bayonet	1/4"	4247N-B119	BG-4247N-B119	4247N-B129	BG-4247N-B129
	3/8"	4247N-B111	BG-4247N-B111	4247N-B121	BG-4247N-B121
PTC to PTC	1/4"	4247N-C119	BG-4247N-C119	4247N-C129	BG-4247N-C129
	3/8"	4247N-C111	BG-4247N-C111	4247N-C121	BG-4247N-C121



## Hose Barb Dry Boom Nozzle Bodies-No DCV

Single hose barb P/N	Double hose barb P/N	Triple hose barb P/N	Hose ID	
			US Units	Metric Units
4231N-B101S	4231N-B101D	4231N-B101T	3/8"	10 mm
4231N-B102S	4231N-B102D	4231N-B102T	1/2"	13 mm
4231N-B103S	4231N-B103D	4231N-B103T	3/4"	19 mm



## Wet Boom Single Nozzle Bodies-No DCV

Single hose barb P/N	Hose ID
4201N-B102	1/2" clamp
4201N-B103	3/4" clamp
4201N-B104	1" clamp

Add Suffix "-00" for 1 part per retail bag.

## Replacement Nozzle Body Stem Seals

Part Number	Description/Material
1723-0142	10 mm Wet Boom Stem Seal-EPDM
1721-0220	10 mm Wet Boom Stem Seal-Viton



## Replacement Seal/O-ring Kit ProFlo Body

Part Number	Description/Material
3430-0754	Contains all internal seals/EPDM
3430-0754V	Contains all internal seals/Viton®



## Screw, Nut & Stem O-ring Kit

Part Number	Description/Material
3430-0755	Contains replacement screw, nut and stem o-ring/EPDM
3430-0755V	Contains replacement screw, nut and stem o-ring/Viton



# EXPRESS Nozzle Body End Caps and Fittings

Terminates the pipe at the last nozzle body, eliminating six inches of dead-ends from each pipe end for better boom hygiene.

Creates a cleaner looking plumbing system by eliminating the need for an extra fitting at the end of the boom

Optional cleanout port for easy boom flushing

Eliminates trapped air from the boom by allowing air to escape through the nozzle body, reducing nozzle turn-off time by 85%

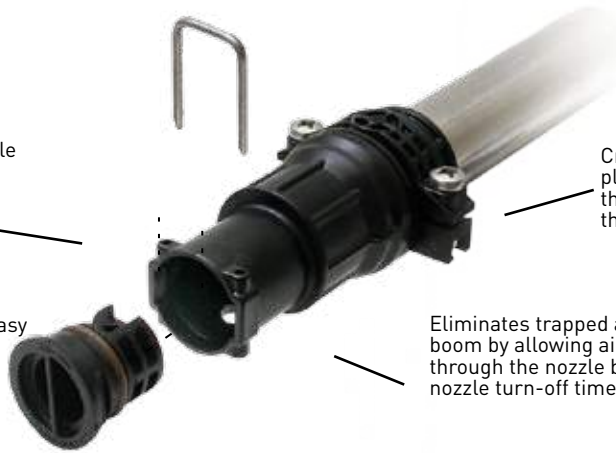

## Express Nozzle Body End Cap



Part Number (Carton Qty: 100)	Part Number (1 per Bag)	Description	Nozzle Body Type
7433-3316	BG-7433-3316	1" Express™ fitting with nozzle body end cap allows trapped air to escape through the nozzle body and includes removable plug for boom cleanout.	10 mm Stem
7433-3314	BG-7433-3314		13 mm Stem

## Express Nozzle Body End Cap Retrofit Kit



Part Number	Description	Cutting Jig Material	Nozzle Body Type
3410-0044	Kit includes machinist-quality drill bit, drilling and cutting jig for 1" pipe, Emery cloth, and instructions to retrofit conventional wet boom spray pipe for Express nozzle body end caps.	Aluminum	10 mm Stem
3410-0043		Aluminum	13 mm Stem



We recommend using a Ridgid Pipe Cutter.  
Available at any hardware store.

## Express Wet Boom Fittings

Part Number (Carton Qty: 50)	Part Number (1 per Bag)	Description	Ref #
7433-2502	BG-7433-2502	Express Fitting X 1" Universal Flange Straight	1
7433-2503	BG-7433-2503	2 Express Fitting X 1" Universal Flange Tee (Vertical)	2
7433-2515	BG-7433-2515	2 Express Fitting X 1" Universal Flange Tee (Horizontal)	3
7433-2608	BG-7433-2608	Express Fitting X 1" Hose Barb Straight	4
7433-2610	BG-7433-2610	Express Fitting X 1" Hose Barb Elbow Vertical	5
7433-2601	BG-7433-2601	Express Fitting X 1" Hose Barb Elbow Horizontal	6
7433-2613	BG-7433-2613	Express Fitting X 1" Male Cam Lock Straight	7
--	UFG0100E-A	1" EPDM Universal Flange Gasket provides high quality sealing for flanged fittings	8
2910-0026	BG-2910-0026	Express Clamps & Hardware Kit	9
3430-0790	BG-3430-0790	Express Clamps & Hardware Kit with Pipe O-rings	10

For high quality sealing to flange fitting, use Hypro's Universal Flange Gasket.



# Nozzle Body Shut-Off Controls



## ProStop-E

- Control spray activation directly on Hypro ProFlo nozzle bodies
- Instantaneous on-off control with 12 volt actuation eliminates misapplication and waste
- Eliminates the need for centralized valve banks allowing on/off control at the nozzle body for individual or small section control
- Two actuation mode options:
  - Simple, 3-wire, 12 volt on/off actuation
  - Operate as an individually addressed valve on a CAN bus/ISO bus system
- Robust, quarter-turn electric ball valves are highly reliable as compared to solenoid and plunger valves
- Innovative locking collar mechanism allows for easy adjustments to valve orientation on the nozzle body
- Extremely low continuous power consumption
- High flow capacity in a compact valve design

## ProStop-E - 12 Volt Actuated On/Off Nozzle Control

Part Number	Description
3305-0011	ProStop-E valve assembly fits all Hypro ProFlow nozzle bodies in place of the check valve

## ProStop



- Rapidly and accurately start and stop nozzle flow
- Compatible with convenient push-connect air fittings and tube
- Connect one air circuit per boom section
- Air pressure activates spray, spring closure provides positive shut-off for transport and storage
- Durable and chemically-resistant polypropylene, PVDF, and EPDM components
- A 40 psi (3 bar) pneumatic signal controls a maximum spray pressure of 150 psi (10 bar)
- Operational temperature range: 41°F to 113°F (5°C to 45°C)
- ProStop can be specified in place of the diaphragm check valve (DCV) on select ProFlo nozzle bodies. Add suffix "PS" to nozzle body part number shown.

## ProStop-Air-Actuated On/Off Nozzle Control Control

Part Number	Description
PS3/4F-PN	PROSTOP valve assembly

## Replacement Check Valve (DCV) includes Flynut, Housing and Spring



Housing Reference	Spring Pressure Plunger Reference Color				
	4 PSI (.28 BAR) Orange	8 PSI (.55 BAR) Black	12 PSI (.83 BAR) Yellow	20 PSI (1.38 BAR) Gray	25 PSI (1.72 BAR) Blue
Red	4200-0010	4200-0020	4200-0030	4200-0040	4200-0050
Green	4200-0010V	4200-0020V	4200-0030V	4200-0040V	4200-0050V

Red housing indicates for use with EPDM Seals. Green housing indicates for use with Viton Seals.  
Note: Diaphragms are sold separately.

## Replacement Diaphragm Seal Options for check valves



Option	Part Number	Color Reference
EPDM	4200-0004E	Black
Viton®	4200-0004V	Green

## Positive Shut-off



Part Number	Description
4200-0025	8 PSI (.55 bar) DCV with positive shut-off

# Nozzle Body Accessories



## Wet Boom Blanks

Part Number	Material	Description
400059	Nylon	3/4" Pipe
400069	Nylon	1" Pipe
400059P*	Polypropylene	3/4" Pipe
400069P*	Polypropylene	1" Pipe

\*Comes standard with Viton® o-ring.



## Series 404 Swivel and Threaded-Swivel Nozzle Bodies

Part Number	Description
4200N-0020	Single Swivel 1/4" FNPT X Quick Attach
4200N-0021	Double Swivel 1/4" FNPT X 2 Quick Attach
4200N-0023	Single 1/4" FNPT X 11/16" - 16UN(M)
4200N-0024	Double 1/4" FNPT X 11/16" - 16UN(M)
4200N-0025	Red Retaining Cap 11/16" - 16UN(F)
4200N-0026	Black Retaining Cap 11/16" - 16UN(F)

## Hose Drops



Part Number	Length		Description Outlet, Inlet
	US Units	Metric Units	
430001	15"	38.1 cm	1/4" NPT, 11/16" - 16UN(M)
430002	24"	60.9 cm	1/4" NPT, 11/16" - 16UN(M)
430201	15"	38.1 cm	1/4" NPT, Quick Attach Fitting
430202	24"	60.9 cm	1/4" NPT, Quick Attach Fitting
430201V	15"	38.1 cm	1/4" NPT, Quick Attach Fitting with Viton
430202V	24"	60.9 cm	1/4" NPT, Quick Attach Fitting with Viton



## Ball Nozzle Holders

Part Number	Ball Thread	Attach Method
40867BN	1/4" FNPT	Handlock Clamp 1" pipe
40868BN	1/4" FNPT	Handlock Clamp 1-1/4" pipe
4081B0N	1/4" FNPT	Threaded 1/4" MNPT

# Nozzle Body Accessories

## 11/16" UN Nozzle Bodies



Reference Number	Standard Pack	Description		Nylon Part Number	Poly Part Number
		US Units			
1	25	11/16" - 16UN(M) X 1/4" (6 mm) HB Elbows		NTL14	3NTL14
1	25	11/16" - 16UN(M) X 3/8" (10 mm) HB Elbows		NTL38	3NTL38
1	25	11/16" - 16UN(M) X 1/2" (13 mm) HB Elbows		NTL12	3NTL12
1	25	11/16" - 16UN(M) X 5/8" (16 mm) HB Elbows		NTL58	3NTL58
1	25	11/16" - 16UN(M) X 3/4" (19 mm) HB Elbows		NTL34	3NTL34
2	25	11/16" - 16UN(M) X 3/8" (10 mm) HB Tees		NTT38	3NTT38
2	25	11/16" - 16UN(M) X 1/2" (13 mm) HB Tees		NTT12	3NTT12
2	25	11/16" - 16UN(M) X 5/8" (16 mm) HB Tees		NTT58	3NTT58
2	25	11/16" - 16UN(M) X 3/4" (19 mm) HB Tees		NTT34	3NTT34
3	25	11/16" - 16UN(M) X 3/8" (10 mm) HB Crosses		T38C	3T38C
3	25	11/16" - 16UN(M) X 1/2" (13 mm) HB Crosses		T12C	3T12C
3	25	11/16" - 16UN(M) X 3/4" (19 mm) HB Crosses		T34C	3T34C
4	25	11/16" - 16UN(M) X 3/8" (10 mm) HB Nozzle Shanks Straight		38D	338D
4	25	11/16" - 16UN(M) X 1/2" (13 mm) HB Nozzle Shanks Straight		3812D	33812D
5	25	11/16" - 16UN(F) X 1/4" (6 mm) FNPT Female Spray Nozzle Adapter		NF1614	3NF1614
6	25	11/16" - 16UN(M) X 1/4" (6 mm) MNPT Nipples		NB1614	3NB1614
6	25	11/16" - 16UN(M) X 1/2" (16 mm) MNPT Nipples		NB1612	3NB1612
7	25	3/8" FNPT X 11/16" - 16UN(M) Ball Check Valve for nozzle fittings (10 PSI/.69 BAR)		NBC10	-----

Includes B12/3B12 nut.  
 Add Prefix "BG-" for 1 part per retail bag.  
 Add Prefix "5BG-" for 5 parts per retail bag.

## 11/16" UN Nozzle Body Cap and Nut

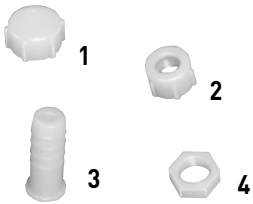

Reference Number	Standard Pack	Description	Nylon Part Number	Poly Part Number
1	25	11/16" - 16UN(F) Nozzle blank cap	3942*	33942*
2	25	11/16" - 16UN(F) Nozzle cap for nozzle/barb	8027*	38027*
3	25	1/4" (6 mm) HB for 8027/38027 cap	K8414	3K8414
3	25	3/8" (10 mm) HB for 8027/38027 cap	K8438	3K8438
3	25	1/2" (13 mm) HB for 8027/38027 cap	K8412	3K8412
4	25	11/16" - 16UN jamb nut	B12*	3B12*

\*Fits all nozzle fittings with 11/16" male straight thread.



## 1" Boom Clamp

Part Number	Standard Pack	Material	Description
2910-0037	25 sets	Polypropylene	1" Boom Clamp to hold 1" pipe on a boom structure

Fasteners not included

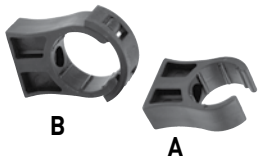

## Cobra Clip Boom Pipe Mounts

Part Number	Ref.	Description
0113434307	A	3/4" or 25mm nominal boom pipe mount
0113434308	B	1" or 32mm nominal boom pipe mount w/ keep strap
01134343010	B	1-1/2" or 40mm nominal boom pipe mount w/ keep strap



## Black Polypropylene Boom Pipe (Undrilled) - Schedule 80 - 20 ft Sections

Part Number	Nominal Pipe Size	Pipe Length		Wall Thickness	Wall Tolerance	Outside Diameter		Max. Operating Pressure @ 73° F/22.8° C	
		US Units	Metric Units			US Units	Metric Units	PSI	BAR
8034-F-00PP	3/4"	20 ft	6.1 m	0.154	+0.020	1.050	26.7 mm	270	18.6
801-F-00PP	1"	20 ft	6.1 m	0.179	+0.021	1.315	33.4 mm	250	17.2
80112-F-00PP	1-1/2"	20 ft	6.1 m	0.220	+0.021	1.905	48.4 mm	200	13.8

# Nozzle Body Accessories & Foam Marker



## Quick Fitting Adapters

Reference #	Part #	Description	Packaging
-	4200-0015N	1/4" BSP x Quick Attach	None
1	4200-0016N	1/4" MNPT x Quick Attach	None
2	4200N-0017	45° Double Elbow w/Gasket	10/ Bag, Priced Individually
3	4200N-0018	90° Elbow x Quick Attach	10/ Bag, Priced Individually
4	4200-0019	1/4" FNPT x Quick Attach	None
5	9950-0024	Hardi* Adapter	10/ Bag, Priced Per Bag
6	9950-0027	Jacto** Adapter	10/ Bag, Priced Per Bag
7	CPV007	3/8" HB x 1/4" FNPT w/ Boom clamp	None
8	BG-400275N	1/4" FNPT x Quick Attach	1/Bag

\* Hardi is a registered trademark of Hardi International A/S

\*\* Jacto is a registered trademark of Jacto, Inc.

## Vari-Spacing Clamps



Part Number	Material	Piping/Tubing O.D.
413003*	Steel	3/4" [26.7 mm] Round Pipe [1.050"]
413004*	Steel	1" [33.5 mm] Round Pipe [1.315"]
413005*	Steel	1-1/4" [42 mm] Round Pipe [1.660"]
413013	Steel	3/4" [19 mm] Square Tubing
413014	Steel	1" [25 mm] Square Tubing
413015	Steel	1-1/4" [32 mm] Square Tubing
413016	Steel	1-1/2" [38 mm] Square Tubing
413018	304 Stainless Steel	1-1/2" [38 mm] Square Tubing

\* By pipe, dimensions refer to I.D. (inner diameter).

Add Prefix "BG-" for 1 part per retail bag

## ProFlo Dry Boom Clamps with Slot for Easy Assembly- Boxes of 100



Part Number	Material	Piping/Tubing O.D.
1520-1075	zinc plated steel	3/4" [14 mm] square tubing
1520-1100	zinc plated steel	1" [25 mm] square tubing
1520-1125	zinc plated steel	1-1/4" [32 mm] square tubing
1520-1150	zinc plated steel	1-1/2" [38 mm] square tubing
1520-1075SS	304 stainless steel	3/4" [19 mm] square tubing
1520-1100SS	304 stainless steel	1" [25 mm] square tubing
1520-1125SS	304 stainless steel	1-1/4" [32 mm] square tubing
1520-1150SS	304 stainless steel	1-1/2" [38 mm] square tubing

Add Prefix "BG-" for 1 part per retail bag

## Steel Boom Clamps for use with 11/16" Nozzle Bodies

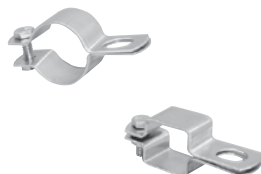

Part Number	Description
BC34R*	3/4" [26.7 mm] Round Pipe
BC100R*	1" [33.4 mm] Round Pipe
BC100	1" [25 mm] Square
BC114	1-1/4" [32 mm] Square

\* Dimensions refer to I.D. (inner diameter).

## Foam Marker

Part Number	Part Number	Description
520005	52520005	Foam Marker System

Available for order through HYPRO -EU only (Cambridge, UK)



- Save money and increase efficiency by avoiding costly misses and overlaps while spraying
- Covers up to 500 acres (200 hectares) with only a 5-gallon (19 litre) tank
- No pre-mixing required - foam is made in the drop assembly at the end of the boom
- Fits any crop sprayer, turf sprayer or seeding machine (extra hose required for booms longer than 60 feet (18 m) - part # 520000-751)
- Electro-pneumatically operated, requiring a 12-volt DC 6 Amp power supply
- 108' (33 m) dual liquid/air hose with thermoformed polystyrene covering for UV protection

# PROCAP Tank Lids

ProCap tank lids feature a rugged design that is easy to use and provides a safe and secure cover for a variety of tanks. All lids are made from sturdy polypropylene material to withstand harsh chemicals and ultraviolet rays.



## Increased Labyrinth Breather capacity supports higher tank filling rates

### Labyrinth Breather

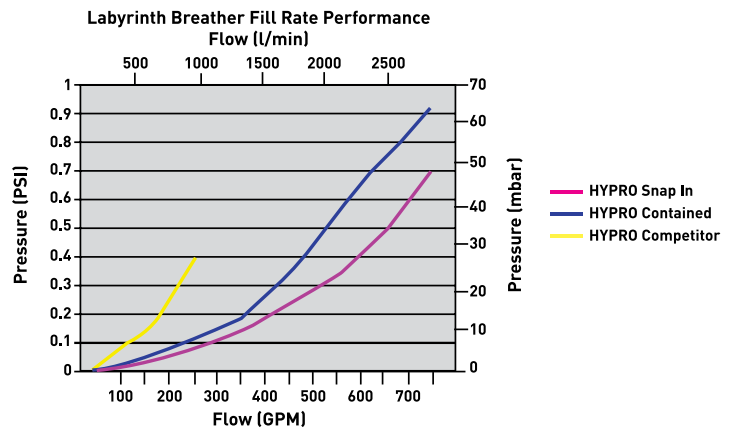
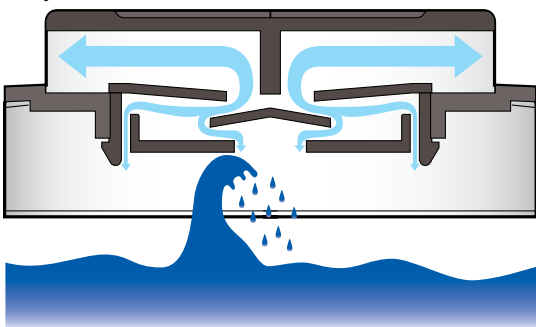

As depicted in the graph above, the Hypro Labyrinth Breather consistently performs at a higher fill rate and lower pressure than the typical competitor.



### Female-Threaded Lids with Gasket

Lid Size	Breather Type	Thread Type	Part Number
4"	Diaphragm	Universal	354230
6"	None	Universal	TL06-0003
6"	Spring	Universal	TL06-0004

- Easily replaces an old or lost lid
- Available as a solid lid or with a breather
- Universal thread has larger diameter to fit any tank thread

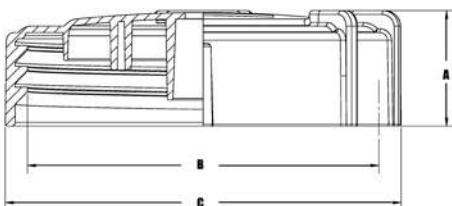

### Female-Threaded Tank Lid Dimensions

Part Number	A IN(MM)	B IN(MM)	C IN(MM)
354230	1.44 (36.5)	4.17 (106)	4.8 (122)
TL06-0003	1.85 (47)	5.66 (144)	6.35 (161)
TL06-0004	1.85 (47)	5.66 (144)	6.35 (161)

# PROCAP Tank Lids



- Easily mounted on a flat surface, the ProCap tank lids are available as a solid lid, with a labyrinth breather, or a bullet breather
- ProCap lid and ring assembly features DuraLok technology, a unique twist and lock closing system
- DuraLok gasket sold separately.

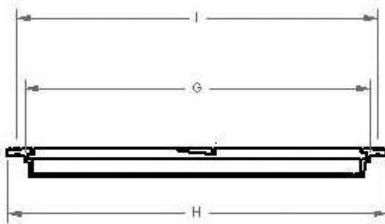
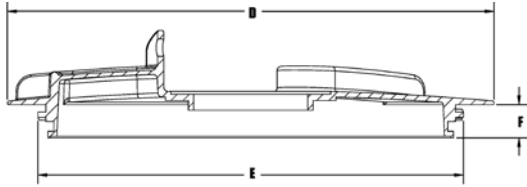

G = Inside diameter for leak content  
H = Outside diameter  
I = Screw hole diameter

## Tank Lids and Ring Assemblies with DuraLok™ Technology

Breather Type	8"	12"	16"
Solid Lid/Ring	TL08-0001	TL12-0001	TL16-0001
Labyrinth Lid/Ring	TL08-0002	TL12-0002	TL16-0002
Bullet Breather Lid/Ring	TL08-0003	TL12-0003	TL16-0003
Solid Lid	TL08-0011	TL12-0011	TL16-0011
Labyrinth Lid Only	TL08-0012	TL12-0012	TL16-0012
Bullet Breather Lid	TL08-0013	TL12-0013	TL16-0013
Ring Only	TL08-0014	TL12-0014	TL16-0014
Gasket	TLP-0007	TLP-0018	TLP-0023

## DuraLok Lid Dimensions

Lid Size	D IN(MM)	E IN(MM)	F IN(MM)
8"	10(254)	8.3(210)	.96(24)
16"	18.1(460)	16.2(411)	.96(24)

## DuraLok Ring Dimensions

Lid Size	I IN (mm)	G IN (mm)	H IN (mm)
8"	9.2 (284)	8.25 (210)	10.1 (257)
16"	17.4 (442)	16.3 (414)	18.3 (465)



## 180° Hinged Tank Lids with DuraLok Technology

- Easily mounted on a flat surface, the ProCap tank lids are available with a labyrinth breather or a bullet breather
- ProCap hinged tank lids feature DuraLok technology, a unique twist and lock closing system
- Lids come standard with a locking hasp for added security
- The 180° hinged design allows the lid to open completely for easy tank access
- EPDM lid gasket is included

Breather Type	Lid Size	
	12"	16"
Labyrinth	TL12-0006	TL16-0006
Bullet	TL12-0007	TL16-0007
Gasket	TLP-0018	TLP-0023



# Tank Lids



- Available as a solid lid or with a labyrinth breather

## ARAG® Male-Threaded Tank Lids and Ring Assemblies

Breather Type	6"	8"	12"	16"	22"
Solid Lid/Ring	3522100-1	3522120-1	3522140-1	3522160-1	352180-1
Labyrinth Lid/Ring	-	3522221-1	3522040-1	3522060-1	352080-1
Solid Lid	3522100	3522120	3522140	3522160	352180
Lid with Labyrinth	3522200	3522221	3522040	3522060	352080
Ring - Standard	350401	3502420	3502440	3502460	350480
Ring with C Gasket	-	TLP-0046	350640	350660	350680
Sealing Gasket Between Tank & Ring	-	350420-020	350440-020	350460-020	350480-020
Wiper Gasket Between Lid & Ring	352000-020	3522120-020	3522140-020	3522160-020	-
C Gasket	-	350620-020	350640-020	TLP-0050	350680-020

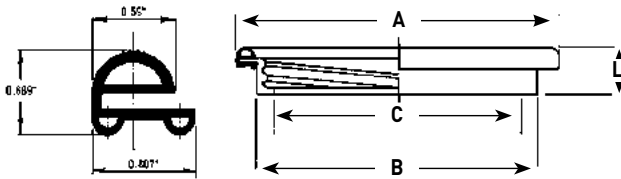
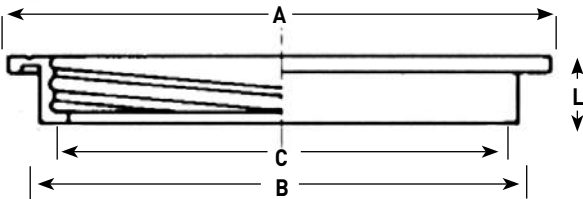
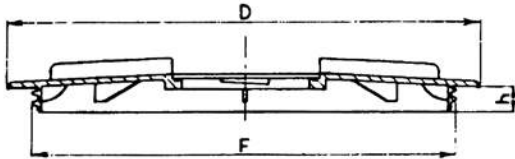

## Male-Threaded Tank Lid Dimensions

Lid Size	D IN/MM	F IN/MM	H IN/MM
6"	5.5/140	4.3/110	-
8"	9.8/250	8.3/210	1.2/31
12"	14.0/355	12.3/313	1.2/31
16"	17.9/454	16.1/410	1.0/25
22"	24.4/620	22.3/567	1.2/30

## Standard Ring Dimensions

Lid Size	A IN/MM	B IN/MM	C IN/MM	L IN/MM
6"	6.3/159	4.9/125	4.4/112	0.7/17
8"	10.0/255	8.5/215	7.6/192	1.5/38
12"	14.2/360	12.6/320	11.4/290	1.5/38
16"	18.2/462	16.3/415	15.0/382	1.4/35
22"	24.4/620	22.6/575	21.3/540	1.6/41

## Ring with "C" Gasket Dimensions

Lid Size	A IN/MM	B IN/MM	C IN/MM	L IN/MM
8"	10.0/255	8.5/215	7.6/192	1.5/38
12"	14.0/355	12.6/320	11.4/290	1.5/38
16"	18.1/460	16.3/415	15.0/382	1.4/35
22"	24.4/620	22.6/575	21.3/540	1.6/41



## Hinged Tank Lids

Part Number	Part Number	Size	Description
356040	Y01356040	12"	Hinged Lid/Ring with Bullet Breather
356041	-	12"	Hinged Lid/Ring with Bullet Breather and Locking Lid
356240	-	12"	Hinged Lid/Ring with Labyrinth Breather
356241	-	12"	Hinged Lid/Ring with Labyrinth Breather and Locking Lid
356060	0135606H	16"	Hinged Lid/Ring with Bullet Breather
356061	Y01356061	16"	Hinged Lid/Ring with Bullet Breather and Locking Lid
356260	-	16"	Hinged Lid/Ring with Labyrinth Breather
356261	-	16"	Hinged Lid/Ring with Labyrinth Breather

Available for order through HYPRO-EU only (Cambridge, UK)

## Gaskets for Hinged Tank Lids

Part Number	Description
356640-020NB	12" Wiper Gasket between Lid and Ring
356660-020NB	16" Wiper Gasket between Lid and Ring

## Arag Hinged Dimensions

Lid Size	D-IN (mm)	B-IN (mm)	L-IN (mm)	M-IN (mm)	S-IN (mm)
12"	14.45 [367]	12.60 [320]	3.98 [101]	1.04 [26]	15.35 [390]
16"	18.19 [462]	16.34 [415]	3.98 [101]	1.04 [26]	19.13 [486]

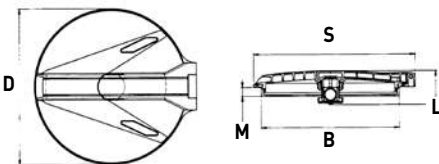

ARAG® is a registered trademark of ARAG.  
Hypro® is a registered trademark of Pentair.

# Tank Accessories



## ProClean High Performance Tank and Container Wash Nozzles

Part Number	Photo Reference	Description
PC1/2F-36075	A	ProClean container nozzle
30B48NF70E35	B	ProClean Plus nozzle
PC1/2F-235120	C	ProClean tank nozzle
PV1/2F1/2M-MA	D	ProClean push-valve assembly
PC1/2F-36075-PV	A & D	ProClean container nozzle and valve



- ProClean tank and container nozzles are designed for better and faster cleaning of empty agrochemical containers and the inside of sprayer tanks
- Chemically-resistant and durable PVDF polymer construction
- ProClean Rotating Container Nozzle utilizes four fluid-driven rotating jets that target all corners of the container
- ProClean Plus Static Blade Container Nozzle has a powerful single blade jet that is directed upwards at 35°; Cuts through residues at the base of containers
- ProClean Rotating Tank Nozzle utilizes eight fluid-driven rotating jets that cover upper tank surfaces for complete rinsing
- Easy operation push-valve is activated with the same force regardless of liquid pressure

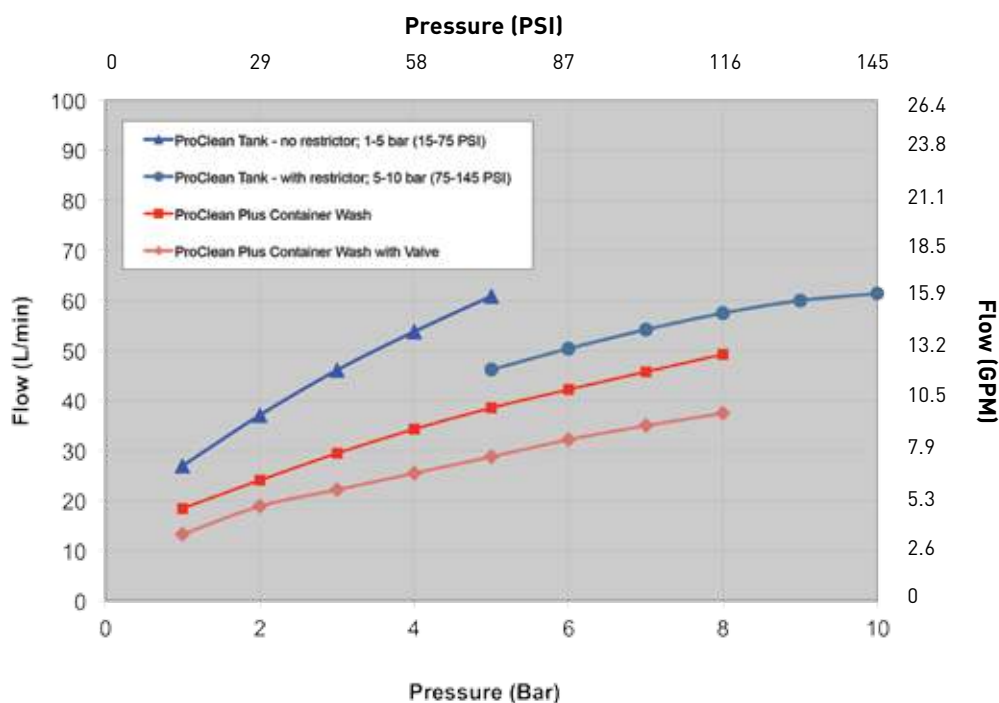

## Basket Filters



Part Number	Size	Basket Height mm[in]	Mesh
9950-55203	5.5"	203 [8"]	18
9950-08050	8"	50 [2.0"]	18
9950-08120	8"	120 [4.7"]	18
9950-08240	8"	240 [9.4"]	18
9950-12060	12"	60 [2.4"]	18
9950-12240	12"	240 [9.4"]	18
9950-16180	16"	180 [7.1"]	18
9950-16280	16"	280 [11.0"]	18
9950-16320	16"	320 [12.6"]	18

## Bulkhead Fitting

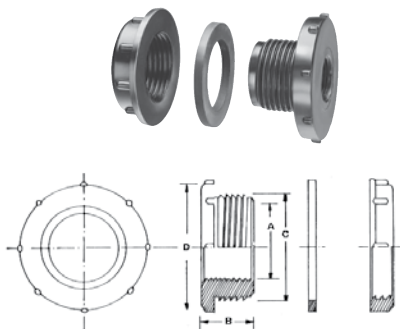

Part Number	A	B	C	D	Material	Gasket Part Number	Gasket Material
WBH12	1/2" NPT	1-3/16" (30 mm)	1-5/8" (41 mm)	2-3/4" (70 mm)	Polypropylene	WBH12/34GAS	Santoprene
WBH34	3/4" NPT	1-3/16" (30 mm)	1-5/8" (41 mm)	2-3/4" (70 mm)	Polypropylene	WBH12/34GAS	Santoprene
WBH100	1" NPT	1-7/8" (48 mm)	2-1/16" (52 mm)	2-7/8" (73 mm)	Polypropylene	WBH100GAS	Santoprene
WBH114	1-1/4" NPT	1-7/16" (37 mm)	2-1/2" (64 mm)	3-3/8" (86 mm)	Polypropylene	WBH114/112GAS	Santoprene
WBH112	1-1/2" NPT	1-7/16" (37 mm)	2-1/2" (64 mm)	3-3/8" (86 mm)	Polypropylene	WBH114/112GAS	Santoprene
WBH200	2" NPT	1-5/8" (41 mm)	3-1/8" (79 mm)	4-1/4" (108 mm)	Polypropylene	WBH200GAS	Santoprene
WBH300	3" NPT	1-3/4" (44 mm)	4-1/4" (108 mm)	5-1/2" (140 mm)	Polypropylene	-	-
WBH400	4" NPT	4-3/16" (106 mm)	5-1/2" (140 mm)	7" (178 mm)	Polypropylene	-	-

Add Prefix "BG-" for 1 part per retail bag.



## Jet Agitators

Part Number	Ref. Number	Thread	Max. Input: Output Ratio	Material
3371-0019	1	3/4" NPT (M) x 3/4" NPT (M)	3:9	Polypropylene
3371	2	1/2" NPT (F) in, 3/4" NPT (M) out	3:4	Polypropylene
3371-0028	3	3/4" NPT (M) (high volume)	5:1	Polypropylene
3R12	4	1/2" NPT (M) Tee	—	Polypropylene
502069	5	1/2" NPT 9 mm Nozzle with Swivel	—	Polypropylene
52169	5	1/2" NPT 9 mm Nozzle	—	Polypropylene

## Labyrinth Air Valve



Part Number	Description
504203-HYP	Polypropylene Labyrinth Air Valve with 1" male connection
G40004	Gasket for installation in tank

## Floating Ball Vent Valve



Part Number	Description
504210*	Polypropylene Floating Ball Vent Valve
500615-060	Optional Spring for no-spill applications

\*2.35" tank hole dimension required for installation.

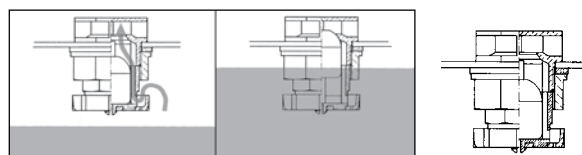

# Cleanload Chemical Eductor

## For Safe Loading of Chemicals into Spray Tanks



3376 Series  
Right hand flow shown.

- The Cleanload is a self-contained eduction system which allows the operator to mix liquid and dry chemicals safely and quickly
- All crop protection chemistry is mixed at ground level, ensuring the safety of both the operator and the environment
- Equipped with tank rinse, designed to completely wash the Cleanload hopper
- ProClean™ bottle rinse (see page 232 for more information) allows operator to triple rinse chemical containers on-site
- Optional suction lance allows the operator to educt bulk liquid and dry chemicals (wetable powders, dry flowables and water-dispersible granules) from large containers without secondary handling
- See page 235 for performance information on all Cleanload models and Eductors

### Order Information

Part Number	Tank Size	Eductor	Flow	Tank Rinse Style	Inlet/Outlet Connection Size	Bottle Rinse Assy	ISO Outlet Screen	Suction Lance
3376-0870	7 Gallon (26 Litre)	Turf/Diaphragm Poly - (08mm) High Pressure/Low Flow	Right Hand	Premium Sidewall Rinse System	220 Universal Flange	Yes	Yes	Optional Accessory
3376-0871	7 Gallon (26 Litre)	Turf/Diaphragm Poly - (08mm) High Pressure/Low Flow	Left Hand	Premium Sidewall Rinse System	220 Universal Flange	Yes	Yes	Optional Accessory
3376-1170	7 Gallon (26 Litre)	On-Board Sprayer Poly - (11mm) High Pressure/High Flow	Right Hand	Premium Sidewall Rinse System	220 Universal Flange	Yes	Yes	Optional Accessory
3376-1171	7 Gallon (26 Litre)	On-Board Sprayer Poly - (11mm) High Pressure/High Flow	Left Hand	Premium Sidewall Rinse System	220 Universal Flange	Yes	Yes	Optional Accessory
3376-1670	7 Gallon (26 Litre)	Transfer Pump Poly - (16mm) Low Pressure/High Flow	Right Hand	Premium Sidewall Rinse System	220 Universal Flange	Yes	Yes	Optional Accessory
3376-1671	7 Gallon (26 Litre)	Transfer Pump Poly - (16mm) Low Pressure/High Flow	Left Hand	Premium Sidewall Rinse System	220 Universal Flange	Yes	Yes	Optional Accessory
3430-0823	Suction Lance snaps into tank outlet for remote loading of bulk chemical containers							
3430-0807	16" Replacement tank lid							

# Closed System Cleanload

## Safe, Fast, & Simple Chemical Loading System



- Chemical loading system that is compliant with Closed System Regulation
- Enclosure accommodates many container sizes and fits up to two 2.5 gallon containers at one time
- Allows operator to re-seal partially used containers with the original chemical container cap
- Easily measure both large and small volumes of chemicals inside enclosure

### Order Information:

Part Number	Application:	Nozzle	Frame
3377-1170	Sprayer Pump High Pressure/High Flow	11 mm	Yes
3377-1171			No
3377-1670	Transfer Pump Low Pressure/High Flow	16 mm	Yes
3377-1671			No

# Cleanload Poly or Stainless Steel Educator



### Poly Educator:

- Market leading eduction rates designed for real world applications
- Optimizes system plumbing costs with an integrated 1/2" push-to-connect port for tank rinse
- One-piece polypropylene educator assembly with mounting bosses and 220 Universal Flange ports
- Choose from three nozzle sizes along with right or left-hand push-to-connect orientation to fit your specific application
- Rinse port shown in right-hand configuration. Left-hand configuration is 180° from shown.

### 316 Stainless Steel Educator:

- Inlet and outlet ports are flynut-ready, offering a wrench-free connection of hoses for easy installation and servicing
- Dual-ported to accommodate rinse port for either left-hand or right-hand flow orientation

### Order Information

Part Number	Application	Nozzle	Rinse Port Orientation	Description
3371-0036	Turf & Diaphragm: High Pressure/Low Flow	8mm	Right Hand	Includes three 220 Universal Flange Gaskets and a 1/2" Push-to-Connect plug
3371-0036R			Right Hand	Educator Only
3371-0037R			Left Hand	Educator Only
3371-0038	On-Board Sprayer: High Pressure/High Flow	11mm	Right Hand	Includes three 220 Universal Flange Gaskets and a 1/2" Push-to-Connect plug
3371-0038R			Right Hand	Educator Only
3371-0039R			Left Hand	Educator Only
3371-0040	Transfer Pump: Low Pressure/High Flow	16mm	Right Hand	Includes three 220 Universal Flange Gaskets and a 1/2" Push-to-Connect plug
3371-0040R			Right Hand	Educator Only
3371-0041R			Left Hand	Educator Only
3371-0034S	On-Board Sprayer: High Pressure/High Flow	12mm	Dual Ported	316 Stainless Steel Educator

### Performance for all Cleanload Models and Educators:

Educator Material:	Poly												Stainless Steel												
	Turf / Diaphragm Pump: High Pressure - Low Flow						On-Board Sprayer Pump: High Pressure - High Flow						Transfer Pump: Low Pressure - High Flow			On-Board Sprayer Pump: High Pressure - High Flow									
Cleanload Part #:	3376-0870 & 3376-0871						3376-1170 & 3376-1171						3376-1670 & 3376-1671			3375 Models									
Educator Part #:	3371-0036, -0036R & -0037R						3371-0038, -0038R & -0039R						3371-0040, -0040R & -0041R			3371-0034S									
Inlet Pressure	Req. Flow		Eduction Rate		Max Outlet Press		Req. Flow		Eduction Rate		Max Outlet Press		Req. Flow		Eduction Rate		Max Outlet Press		Req. Flow		Eduction Rate		Max Outlet Press		
PSI	BAR	GPM	LPM	GPM	LPM	GPM	LPM	GPM	LPM	GPM	LPM	PSI	LPM	GPM	LPM	GPM	LPM	PSI	LPM	GPM	LPM	GPM	LPM	PSI	LPM
10	0.7	-	-	-	-	-	-	-	-	-	-	-	-	46.0	174	24.6	93	5.9	0.4	-	-	-	-	-	-
20	1.4	-	-	-	-	-	-	26.9	102	35.0	133	6.1	0.4	61.4	233	47.8	181	11.5	0.8	29.5	112	16.5	62	4.9	0.3
30	2.1	16.1	61	31.5	119	5.2	0.4	33.5	127	52.2	198	9.2	0.6	73.5	278	61.2	231	16.9	1.2	35.2	133	26.0	98	7.0	0.5
40	2.8	19.1	72	47.0	178	6.6	0.5	38.0	144	64.4	244	12.3	0.8	82.9	314	67.2	254	22.4	1.5	40.4	153	32.9	125	9.0	0.6
50	3.4	21.4	81	54.5	206	8.1	0.6	41.3	157	72.6	275	15.3	1.1	90.3	342	68.3	258	27.8	1.9	45.3	171	39.1	148	11.0	0.8
60	4.1	23.3	88	61.5	233	9.7	0.7	44.4	168	77.7	294	18.2	1.3	96.2	364	66.8	253	33.1	2.3	49.8	189	45.9	174	13.3	0.9
70	4.8	24.9	94	68.0	258	11.2	0.8	47.5	180	80.5	305	21.1	1.5	101.3	384	65.1	247	38.4	2.6	53.8	204	52.4	198	15.5	1.1
80	5.5	26.4	100	74.1	280	12.7	0.9	50.9	193	82.1	311	23.9	1.6	-	-	-	-	-	-	57.5	218	58.0	220	17.8	1.2
90	6.2	28.0	106	79.7	302	14.2	1.0	53.9	204	83.3	315	26.6	1.8	-	-	-	-	-	-	60.7	230	62.0	235	20.0	1.4
100	6.9	29.7	112	84.8	321	15.8	1.1	56.6	214	85.0	322	29.3	2.0	-	-	-	-	-	-	63.6	241	65.0	246	22.3	1.5

# Polypropylene Line Strainers

Rated for 80 psi at 70°F / 5.5 bar at 21°C



Part Number	NPT Threads	Replacement Parts for Polypropylene Line Strainers				
		Cap	Bowl	Screen	Mesh	O-ring
3350-0085A	1/4" I.D. (F) & 1/2" O.D. (M)	3351-0035	3351-0036	3800-0048	20 s.s.	1700-0090 EPDM
3350-0079A		3351-0035	3351-0036	3800-0046	50 s.s.	1700-0090 EPDM
3350-0082A		3351-0035	3351-0036	3800-0047	80 s.s.	1700-0090 EPDM
3350-0056A	1/2"	3351-0037	3351-0039	3800-0029	20 s.s.	1700-0091 EPDM
3350-0046A		3351-0037	3351-0039	3800-0025	50 s.s.	1700-0091 EPDM
3350-0043A		3351-0037	3351-0039	3800-0026	80 on 20 s.s.	1700-0091 EPDM
3350-0040A	3/4"	3351-0038	3351-0039	3800-0029	20 s.s.	1700-0091 EPDM
3350-0034A		3351-0038	3351-0039	3800-0025	50 s.s.	1700-0091 EPDM
3350-0035A		3351-0038	3351-0039	3800-0026	80 on 20 s.s.	1700-0091 EPDM
3350-0057A	1"	3351-0040	3351-0043	3800-0040	20 s.s.	1700-0092 EPDM
3350-0058A		3351-0040	3351-0043	3800-0041	50 s.s.	1700-0092 EPDM
3350-0059A		3351-0040	3351-0043	3800-0042	80 on 20 s.s.	1700-0092 EPDM
3350-0071A	1-1/4"	3351-0041	3351-0043	3800-0043	20 s.s.	1700-0092 EPDM
3350-0072A		3351-0041	3351-0043	3800-0044	50 s.s.	1700-0092 EPDM
3350-0073A		3351-0041	3351-0043	3800-0045	80 on 20 s.s.	1700-0092 EPDM
3350-0112A	1-1/2"	3351-0042	3351-0043	3800-0065	20 s.s.	1700-0092 EPDM
3350-0113A		3351-0042	3351-0043	3800-0066	50 s.s.	1700-0092 EPDM
3350-0114A		3351-0042	3351-0043	3800-0067	80 on 20 s.s.	1700-0092 EPDM

All 1/2", 3/4", 1-1/4" and 1-1/2" have internal (NPT) female ports, polypropylene cap and bowl.

# Polypropylene Line Strainers

Rated for 200 psi at 70°F / 14 bar at 21°C



NPT Part Number	BSP Part Number	BSP Part Number*	Max. PSI	Max. BAR	Threads	Previous Color	Screen Size/ Ref. Color	New ISO Color	Screen
3350-0142N	3350-0142B	20N62230	290	20	1/2" FNPT	White	32 Mesh/White	Red	3800-0086
3350-0143N	3350-0143B	20N62250				Blue	50 Mesh/Blue	Blue	3800-0087
3350-0144N	3350-0144B	20N62280				Gray	80 Mesh/Gray	Yellow	3800-0088
3350-0145N	3350-0145B	-				Red	100 Mesh/Red	Green	3800-0089
3350-0146N	3350-0146B	20N62330	290	20	3/4" FNPT	White	32 Mesh/White	Red	3800-0086
3350-0147N	3350-0147B	20N62350				Blue	50 Mesh/Blue	Blue	3800-0087
3350-0148N	3350-0148B	20N62380				Gray	80 Mesh/Gray	Yellow	3800-0088
3350-0149N	3350-0149B	-				Red	100 Mesh/Red	Green	3800-0089
3350-0150N	3350-0150B	20N62430	290	20	1" FNPT	White	32 Mesh/White	Red	3800-0090
3350-0151N	3350-0151B	20N62450				Blue	50 Mesh/Blue	Blue	3800-0091
3350-0152N	3350-0152B	20N62480				Gray	80 Mesh/Gray	Yellow	3800-0092
3350-0153N	3350-0153B	-				Red	100 Mesh/Red	Green	3800-0093
3350-0162N**	3350-0162B**	-	290	20	1" FNPT	White	32 Mesh/White	Red	3800-0090
3350-0163N**	3350-0163B**	-				Blue	50 Mesh/Blue	Blue	3800-0091
3350-0164N**	3350-0164B**	-				Gray	80 Mesh/Gray	Yellow	3800-0092
3350-0165N**	3350-0165B**	-				Red	100 Mesh/Red	Green	3800-0093
3350-0154N	3350-0154B	20N62530	250	17	1-1/4" FNPT	White	32 Mesh/White	Red	3800-0094
3350-0155N	3350-0155B	20N62550				Blue	50 Mesh/Blue	Blue	3800-0095
3350-0156N	3350-0156B	20N62580				Gray	80 Mesh/Gray	Yellow	3800-0096
3350-0157N	3350-0157B	-				Red	100 Mesh/Red	Green	3800-0097
3350-0166N**	3350-0166B**	203282152**	250	17	1-1/4" FNPT	White	32 Mesh/White	Red	3800-0094
3350-0167N**	3350-0167B**	203282153**				Blue	50 Mesh/Blue	Blue	3800-0095
3350-0168N**	3350-0168B**	2032821535**				Gray	80 Mesh/Gray	Yellow	3800-0096
3350-0169N**	3350-0169B**	-				Red	100 Mesh/Red	Green	3800-0097
3350-0158N	3350-0158B	20N62630	250	17	1-1/2" FNPT	White	32 Mesh/White	Red	3800-0094
3350-0159N	3350-0159B	20N62650				Blue	50 Mesh/Blue	Blue	3800-0095
3350-0160N	3350-0160B	20N62680				Gray	80 Mesh/Gray	Yellow	3800-0096
3350-0161N	3350-0161B	-				Red	100 Mesh/Red	Green	3800-0097
3350-0170N**	3350-0170B**	203282162**	250	17	1-1/2" FNPT	White	32 Mesh/White	Red	3800-0094
3350-0171N**	3350-0171B**	203282163**				Blue	50 Mesh/Blue	Blue	3800-0095
3350-0172N**	3350-0172B**	2032821635**				Gray	80 Mesh/Gray	Yellow	3800-0096
3350-0173N**	3350-0173B**	-				Red	100 Mesh/Red	Green	3800-0097

\*Available for order through HYPRO-EU only (Cambridge, UK)

\*\*Self-cleaning model.

# Nylon Line Strainers

Rated for 150 psi at 70°F / 10.34 bar at 21°C

Rated for 100 psi at 125°F / 6.9 bar at 51.6°C

140°F max./ 60°C max.



Part Number	NPT Threads	Replacement Parts for Nylon Line Strainers				
		Cap	Bowl	Screen	Mesh	O-ring
3350-0085		3351-0022		3800-0048	20 s.s.	1700-0064 Buna-N
3350-0085F	1/4"	3351-0022		3800-0048	20 s.s.	1700-0065 Viton
3350-0079	I.D. (F)	3351-0022	3351-0020	3800-0046	50 s.s.	1700-0064 Buna-N
3350-0079F	&	3351-0022	(Clear)	3800-0046	50 s.s.	1700-0065 Viton
3350-0082	1/2"	3351-0022		3800-0047	80 s.s.	1700-0064 Buna-N
3350-0082F	O.D. (M)	3351-0022		3800-0047	80 s.s.	1700-0065 Viton
3350-0056		3351-0007		3800-0029	20 s.s.	1700-0044 Buna-N
3350-0131		3351-0007	3351-0005	3800-0029	20 s.s.	1700-0045 Viton
3350-0046		3351-0007	(White) or	3800-0025	50 s.s.	1700-0044 Buna-N
3350-0042	1/2"	3351-0007	3351-0015*	3800-0025	50 s.s.	1700-0045 Viton
3350-0043	(F)	3351-0007	(Clear)	3800-0026	80 on 20 s.s.	1700-0044 Buna-N
3350-0068		3351-0007		3800-0026	80 on 20 s.s.	1700-0045 Viton
3350-0040		3351-0006		3800-0029	20 s.s.	1700-0044 Buna-N
3350-0132		3351-0006	3351-0005	3800-0029	20 s.s.	1700-0045 Viton
3350-0034		3351-0006	(White) or	3800-0025	50 s.s.	1700-0044 Buna-N
3350-0044	3/4"	3351-0006	3351-0015*	3800-0025	50 s.s.	1700-0045 Viton
3350-0035	(F)	3351-0006	(Clear)	3800-0026	80 on 20 s.s.	1700-0044 Buna-N
3350-0045		3351-0006		3800-0026	80 on 20 s.s.	1700-0045 Viton
3350-0057		3351-0014		3800-0040	20 s.s.	1700-0057 Buna-N
3350-0060		3351-0014	3351-0013	3800-0040	20 s.s.	1700-0058 Viton
3350-0058	1"	3351-0014	(White) or	3800-0041	50 s.s.	1700-0057 Buna-N
3350-0061	(F)	3351-0014	3351-0024*	3800-0041	50 s.s.	1700-0058 Viton
3350-0059		3351-0014	(Clear)	3800-0042	80 on 20 s.s.	1700-0057 Buna-N
3350-0062		3351-0014		3800-0042	80 on 20 s.s.	1700-0058 Viton
3350-0071		3351-0016		3800-0043	20 s.s.	1700-0057 Buna-N
3350-0074		3351-0016	3351-0013	3800-0043	20 s.s.	1700-0058 Viton
3350-0072	1-1/4"	3351-0016	(White) or	3800-0044	50 s.s.	1700-0057 Buna-N
3350-0075	(F)	3351-0016	3351-0024*	3800-0044	50 s.s.	1700-0058 Viton
3350-0073		3351-0016	(Clear)	3800-0045	80 on 20 s.s.	1700-0057 Buna-N
3350-0076		3351-0016		3800-0045	80 on 20 s.s.	1700-0058 Viton
3350-0112		3351-0026		3800-0065	20 s.s.	1700-0057 Buna-N
3350-0115		3351-0026	3351-0013	3800-0065	20 s.s.	1700-0058 Viton
3350-0113	1-1/2"	3351-0026	(White) or	3800-0066	50 s.s.	1700-0057 Buna-N
3350-0116	(F)	3351-0026	3351-0024*	3800-0066	50 s.s.	1700-0058 Viton
3350-0114		3351-0026	(Clear)	3800-0067	80 on 20 s.s.	1700-0057 Buna-N
3350-0117		3351-0026		3800-0067	80 on 20 s.s.	1700-0058 Viton

\* Clear Polyimide Bowl - Add Suffix "P" - (i.e.: 3350-0057P) - 1/2", 3/4", 1", 1-1/4" and 1-1/2".  
1/2", 3/4", 1", 1-1/4" and 1-1/2" have internal (NPT) Female Ports, Type 6 nylon cap bowl.

## Nylon Suction Strainers

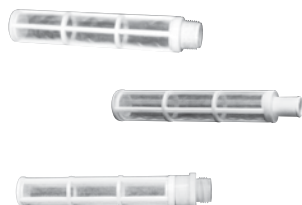

Part Number	Thread	Screen	Estimated Weight Ea.	
			US Units	Metric Units
3350-0069	3/4" NPT (M)	50-mesh nylon	4 oz.	114 g
3350-0032	3/4" (19 mm) hose barb (all nylon)	50-mesh nylon	4 oz.	114 g
3350-0077	garden hose (M)	50-mesh nylon	4 oz.	114 g

# Adjustable Pattern Spray Guns

## 3381-0016

- Adjustable pattern spray gun
- 15" (38 cm) barrel
- 3mm nozzle
- 3/8" (10 mm) MNPT inlet
- Sized for spot spraying



### Order Information

Part Number	Max PSI	Max BAR	Max GPM	Max LPM
3381-0016	120	8	1	4

## 3381-0021

- Adjustable pattern spray gun
- 21" (53 cm) barrel
- 3mm nozzle
- 3/8" (10 mm) and 1/2" (13 mm) hose barb
- Sized for spot spraying



### Order Information

Part Number	Max PSI	Max BAR	Max GPM	Max LPM
3381-0021	60	4	1	4

## 3381-0036

- Adjustable pattern spray gun
- 19" (48 cm) barrel
- 3mm nozzle
- 3/8" (10 mm) hose barb



### Order Information

Part Number	Max PSI	Max BAR	Max GPM	Max LPM
3381-0036	120	8	2.5	10

## 3381-0043 & 3381-0043L

- Adjustable pattern spray gun
- 7-1/4" (18 cm) or 18" (45 cm) barrel
- 2.3mm nozzle
- 3/8" (10 mm) and 1/2" (13 mm) hose barb



### Order Information

Part Number	Barrel Length		Max PSI	Max BAR	Max GPM	Max LPM
	US Units	Metric Units				
3381-0043	7-1/4"	18 cm	600	40	11	18
3381-0043L	18"	45 cm	600	40	11	18
9920-261703-69	Replacement Barrel for 3381-0043					
9920-35.1703.67	Replacement Barrel for 3381-0043L					
3430-0768	Replacement nozzle kit					

## Spray Gun Nozzles for 3381-0043 and 3381-0043L Guns

Part Number	Orifice	Performance	45 PSI		100 PSI		150 PSI		200 PSI		300 PSI		450 PSI		600 PSI	
			Cone	Straight	Cone	Straight	Cone	Straight	Cone	Straight	Cone	Straight	Cone	Straight	Cone	Straight
AMT-15010 replaces 9920-61.1802.45	1.0 mm	GPM spray angle throw, ft	0.24 30° 3.2	0.24 - 8.2	0.35 30° 4.9	0.37 - 13.0	0.40 40° 6.5	0.45 - 18.0	0.53 40° 6.5	0.60 - 18.5	0.57 40° 6.5	0.60 - 19.5	0.70 40° 7.2	0.75 - 21.0	0.83 38° 8.2	0.90 - 23.0
AMT-15012 replaces 9920-61.1802.46	1.2 mm	GPM spray angle throw, ft	0.35 32° 3.9	0.38 - 9.8	0.55 35° 5.5	0.55 - 14.5	0.60 45° 7.2	0.65 - 20.0	0.80 42° 7.2	0.93 - 21.0	0.88 42° 7.2	0.90 - 22.0	1.10 40° 8.2	1.20 - 23.5	1.30 40° 8.2	1.40 - 25.5
AMT-15015 replaces 9920-61.1802.47	1.5 mm	GPM spray angle throw, ft	0.40 32° 3.9	0.50 - 11.5	0.62 35° 6.5	0.80 - 14.5	0.62 45° 8.2	0.93 - 23.0	0.95 45° 8.2	1.25 - 24.0	1.00 42° 8.2	1.30 - 24.5	1.30 42° 8.2	1.70 - 26.0	1.50 42° 10.0	1.95 - 28.0
AMT-15018 replaces 9920-61.1802.48	1.8 mm	GPM spray angle throw, ft	0.50 40° 4.9	0.75 - 13.0	0.73 42° 6.5	1.20 - 16.5	0.85 50° 8.2	1.35 - 26.0	1.15 45° 8.2	1.75 - 27.0	1.20 50° 8.2	1.90 - 28.0	1.60 48° 9.8	2.30 - 31.0	1.75 48° 10.0	2.80 - 33.0
AMT-15020 replaces 9920-61.1802.55	2.0 mm	GPM spray angle throw, ft	0.73 40° 3.9	1.10 - 14.5	1.05 42° 6.0	1.60 - 19.5	1.30 55° 8.2	1.90 - 29.5	1.50 55° 8.2	2.40 - 30.5	1.60 55° 8.2	2.50 - 31.0	1.90 53° 9.8	3.00 - 34.0	2.20 50° 10.0	3.50 - 36.0
AMT-15023 replaces 9920-61.1802.68	2.3 mm	GPM spray angle throw, ft	0.90 40° 4.9	1.40 - 16.5	1.30 42° 6.5	1.90 - 24.5	1.50 55° 10.0	2.30 - 32.0	2.00 55° 10.0	3.20 - 35.0	2.10 55° 10.0	3.30 - 36.0	2.70 53° 9.8	4.10 - 38.0	3.10 51° 10.5	4.80 - 39.0
9920-61.1802.45	4.0 mm	GPM throw, ft	- - -	- - -	- - -	- - -	1.9 10	3.4 36	- -	- -	4.6 10	8.0 38	5.5 10	9.5 40	6.3 12	11.0 40



# Adjustable Pattern Spray Guns

## 3381-0010 and 3381-0011

- Adjustable pattern spray gun
- 17" (43 cm) or 21" (53 cm) barrel
- 3mm or 4mm nozzle
- 1/2" (13 mm) MNPT inlet



## 3381-0013

- Adjustable pattern spray gun
- 7" (18 cm) barrel
- 3mm nozzle
- 1/2" (13 mm) MNPT inlet



### Order Information

Part Number	Barrel Length		Noz- zle	Max PSI	Max BAR	Max GPM	Max LPM
	US Units	Metric Units					
3381-0010	17"	43 cm	3mm	1200	83	25	95
3381-0011	21"	53 cm	4mm	1200	83	30	114
9920-KIT10/11	Repair Kit						
9920-248	Swivel Kit						

### Order Information

Part Number	Max PSI	Max BAR	Max GPM	Max LPM
3381-0013	700	40	19	72
9920-248	Swivel Kit			

## Tree Spraying Guide Hypro Diaphragm Pump Gas Engine Applications

Spray Height	Pump/Engine Model	Engine	Shaft	Spray Gun	Nozzle
30-35 ft.	9910-D252GRGI58 (w/o engine) 9910-D252GRGI (w/o engine) D252GRGI-25 (w/2.5 hp PowerPro™) D252GRGI-55 (w/5.5 hp PowerPro™) 6 GPM; 290 PSI	Min. 2.5 hp SAE j609a flange mount	5/8" 3/4" 5/8" 3/4"	3381-0010 or 3381-0013	3385-3000
35-40 ft.	9910-D30GRGI (w/o engine) D30GRGI-65 (w/6.5 hp PowerPro™) D30HRGI-65 (w/6.5 hp PowerPro™) D30HRGI-65E (w/6.5 hp PowerPro™) 9.5 GPM; 580 PSI	Min. 5.0 hp SAE j609a flange mount	3/4" 3/4" 3/4" 3/4"	3381-0010 or 3381-0013	3385-3000
45-50 ft.	9910-D50 (w/o engine, controller or gearbox) 14 gpm; 580 psi	Min 8.0 hp SAE j609a flange mount	1"	3381-0011	3385-4000
45-50 ft.	9910-D503GRGI (w/o engine) 15 gpm; 580 psi	Min 8.0 hp SAE j609a flange mount	1"	3381-0011	3385-4000
50-57 ft.	9910-D813GRGI (w/o engine) 21 gpm; 725 psi	Min 14.0 hp SAE j609a flange mount	1"	3381-0011	3385-4500
60-68 ft.	9910-D1064GRGI (w/o engine) 28 gpm; 725 psi	Min 18.0 hp SAE j609a flange mount	1"	3381-0011	3385-6000

All GRGI pump models come complete with gear reduction and control valve.

## Performance Chart for Models 3381-0010, 3381-0011 and 3381-0013 Spray Guns

Hypro Model Number	Orifice Diameter In MM	Pressure In PSI** Performance	200 PSI Setting		350 PSI Setting		500 PSI Setting		600 PSI Setting		650 PSI Setting		700 PSI Setting		850 PSI Setting	
			Cone	Straight	Cone	Straight	Cone	Straight	Cone	Straight	Cone	Straight	Cone	Straight	Cone	Straight
3385-1500	1.5	capacity in gpm max throw (ft)*	1.14 9.2	1.26 21.5	1.48 10.3	1.7 25.2	1.8 11.2	2 28	1.9 12.1	2.2 31.8	2 12.1	2.3 32	2.1 12.3	2.4 32.3	2.2 13.1	2.5 34.3
3385-2300	2.3	capacity in gpm max throw (ft)*	2.1 11.4	2.7 29	2.7 12.9	3.7 33.9	3.4 14.8	4.5 37.9	3.8 16.6	4.9 41.5	3.8 17	5 41.7	3.9 17.7	5.1 42	4.2 19	5.8 45.7
3385-3000	3	capacity in gpm max throw (ft)*	2.9 11.7	4.6 29.2	3.7 12.9	6.3 33.9	4.8 13.8	7.5 36.2	5.2 15.6	8.4 40.8	5.3 16	8.5 40.7	5.4 16.2	8.6 42	6 17	9.6 44.1
3385-3500	3.5	capacity in gpm max throw (ft)*	5.8 13.6	6 36.2	7.9 19	8.2 41.2	9.6 22.6	9.9 45.3	10.7 25.5	11.1 50	11 25.5	11.3 51	11.2 27	11.6 51.5	12.4 28.8	12.8 54
3385-4000	4	capacity in gpm max throw (ft)*	7 15.1	7.3 37.7	9.6 20.6	9.9 42.8	11.6 24.3	12 47	12.9 27.2	13.5 53	13.2 27.2	13.8 54	13.6 28.5	14.1 55	15 29	15.6 59
3385-4500	4.5	capacity in gpm max throw (ft)*	8.2 18.1	8.9 39.2	11.1 22.2	12 44.3	13.4 26	14.5 50.1	15 30.6	16.3 54	15.4 30.6	16.6 56	15.7 31	17 57	17.4 31.5	18.9 62
3385-5000	5	capacity in gpm max throw (ft)*	9.8 19.6	10.2 40.7	13.3 23.8	13.8 47	16 27.5	16.7 53.3	18 32.3	18.7 59	18.4 32.3	19.1 61	18.9 32.8	19.5 62	20.8 32.8	21.6 67
3385-5500	5.5	capacity in gpm max throw (ft)*	10.7 19.6	11.5 42.2	14.4 23.8	15.6 50.7	17.4 29	18.8 57	19.6 34	21 63	20 34	21.5 64	20.4 34.5	22 65	22.6 34.5	24.4 70
3385-6000	6	capacity in gpm max throw (ft)*	11.5 21.1	12.6 43.7	15.6 25.3	17.1 54	18.8 30.7	20.6 60	21 35.6	23.2 66	21.5 35.6	23.7 67	22 36	24.2 68	24.4 36	26 9 74
3385-7000	7	capacity in gpm max throw (ft)*	11.5 21.1	13.5 46.8	15.6 25.3	18.4 57	18.8 30.7	22.2 63	21 37.4	25 70	21.5 37.4	25.4 71	22 38	26 72	24.4 38	29 77

\* Figures shown are guidelines for vertical throw.

\*\* Pressures based on relief valve settings at straight throw.

# Adjustable Pattern Spray Guns

## Long range high pressure spray gun



- Brass body
- Stainless steel pipe
- Handle and nozzle protection in high-resistance polymer
- Ergonomic handgrip
- Quick-release trigger lock
- Swivel inlet port
- Adjustable spray pattern from hollow cone to solid stream

### Top Gun

Part Number	Max.PSI	Max.BAR	Max.GPM	Max.LPM	Nozzle Size	Nozzle Number	Connection		Estimated Weight Ea.	
							US Units	Metric Units	US Units	Metric Units
002201-3430	850	60	35.0	130	3.0 mm	003430	1/2" HB	13 mm	3 lbs. 8 oz.	13 kg
002201-3440	850	60	35.0	130	4.0 mm	003440	1/2" HB	13 mm	3 lbs. 8 oz.	13 kg
002201-3460	850	60	35.0	130	6.0 mm	003460	1/2" HB	13 mm	3 lbs. 8 oz.	13 kg
002201-3470	850	60	35.0	130	7.0 mm	003470	1/2" HB	13 mm	3 lbs. 8 oz.	13 kg

Hose barb and nut kit (sold separately): 3/8" - 006320; 1/2" - 006330.

### Pressure (PSI)

		200 PSI		350 PSI		500 PSI		600 PSI		720 PSI	
		Cone	Straight	Cone	Straight	Cone	Straight	Cone	Straight	Cone	Straight
3	Flow GPM	3.8	5.2	5.6	6.8	6.6	8.5	7	9.2	7.3	10
	Max. throw ft.	12	36	13	37	15	41	16	44	21	46
4	Flow GPM	6	8.2	7.3	12.7	8.6	13.2	10.2	14.5	11.4	15.9
	Max. throw ft.	14	42	15	44	16	49	19	52	23	57
6	Flow GPM	9	16	11.5	22.2	14	25.8	15.5	26.7	16.2	27.5
	Max. throw ft.	19	59	21	62	25	66	26	68	31	72
7	Flow GPM	10.5	17.5	13.8	25.7	16.8	30.6	18.2	33.2	20.3	34.3
	Max. throw ft.	21	60	23	67	26	72	27	77	31	82



### Econo Gun

Part Number	Max.PSI	Max.BAR	Max.GPM	Max.LPM	Connection	
					US Units	Metric Units
506532V	150	10	40.0	150	1/2" HB	13 mm
506530V	150	10	40.0	150	3/4" HB	19 mm
506531V	150	10	40.0	150	1" HB	25 mm

# Spray Guns & Lances



3381-0017

## 47 Gun

- Stainless steel ball and seat
- Lightweight, yet durable
- Front entry; Thumb set safety



3381-0018W

## 18 Gun

- Fast, easy servicing
- Stainless steel ball, seat, spring and glands
- Durable insulated handle; Rear entry
- Reduced trigger pressure; Less operator fatigue
- Consistent weep control at 1/4 gpm (+/-15%) on "W" version

Part Number	Inlet/Outlet	Max. PSI	Max. BAR	Max. GPM	Max. LPM	Max Temp	Max Temp
3381-0047	3/8" (F)NPT x 1/4" (F)NPT	2150	150	7.0	27	210° F	100° C

Part Number	Inlet/Outlet	Max. PSI	Max. BAR	Max. GPM	Max. LPM	Max Temp	Max Temp
3381-0018	3/8" (F)NPT x 1/4" (F)NPT	4000	280	9.0	34	300° F	150° C
3381-0018W*							

\* Weep Version



3381-0032W

## 32 Gun

- Stainless steel ball, seat, spring and glands
- Durable insulated handle; Rear entry
- Reduced trigger pressure; Less operator fatigue
- Consistent weep control at 1/4 gpm (+/-15%) on "W" version

Part Number	Inlet/Outlet	Max. PSI	Max. BAR	Max. GPM	Max. LPM	Max Temp	Max Temp
3381-0032	3/8" (F)NPT x 1/4" (F)NPT	4000	280	7.0	27	300° F	150° C
3381-0032W*							

\* Weep Version

## Dual Lance

- Insulated lance; insulated selector handle
- Dual-molded nozzle protectors
- 40" length, rotating handle for proper hi/lo nozzle control "W" version
- Chrome plated



Part Number	Inlet/Outlet	Max. PSI	Max. BAR	Max. GPM	Max. LPM	Max Temp	Max Temp
3365-0002	1/4" (M)NPT x Dual 1/4" (M)	3000	210	10.5	40	300° F	150° C

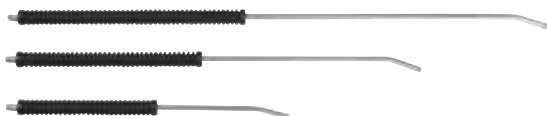

## Zinc-Plated Bent Single Lances with Insulated Handle

Length	Part Number	Inlet/Outlet	Max. PSI	Max. BAR	Max. GPM	Max. LPM	Max Temp	Max Temp
24"	61 cm	3365-0004/24	3600	250	10.5	40	300° F	150° C
36"	91 cm	3365-0004/36						
47"	119 cm	3365-0004/47						



## Zinc-Plated Straight Single Lances with Insulated Handle

Length	Part Number	Inlet/Outlet	Max. PSI	Max. BAR	Max. GPM	Max. LPM	Max Temp	Max Temp
24"	61 cm	3365-0005/24	3600	250	10.5	40	300° F	150° C
36"	91 cm	3365-0005/36						
47"	119 cm	3365-0005/47						



## Rear Entry Spray Gun with Black Lances & Coupler

Part Number	Inlet/Outlet	Max. PSI	Max. BAR	Max. GPM	Max. LPM	Max Temp	Max Temp
3381-0034	3/8" (F)NPT x Quick Coupling (screw type)	3500	240	7.0	27	300° F	150° C

- Stainless steel ball, seat, spring and glands
- Durable insulated handle
- Reduce trigger pressure; Less operator fatigue
- 16" Insulated lance length w/screw coupling

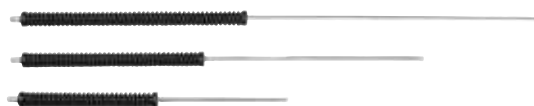

## Zinc-Plated Lance Extensions for 3381-0034 Gun

Length	Part Number	Inlet/Outlet	Max. PSI	Max. BAR	Max. GPM	Max. LPM	Max Temp	Max Temp
14"	36 cm	3365-0007/14	3500	240	10.5	40	300° F	150° C
24"	61 cm	3365-0007/24						
36"	91 cm	3365-0007/36						

# Nozzles



- Variable fan pattern, 0° to 80°
- Push/Pull for pressure adjustment to draw soap
- Twist for fan adjustment

## Hi-Lo Variable Nozzle

Part Number		Nozzle No.	Inlet (NPT)	Max PSI	Max Bar	Max GPM	Max LPM	Max Temp	Max Temp
Variable	Hi-Lo Variable								
-	3324-2000.85	2.0	1/4" (F)	3000	210	8.0	30	300° F	150° C
3324-1001.05	3324-2001.05	3.0							
3324-1001.1	3324-2001.1	3.5							
3324-1001.15	3324-2001.15	3.7							
3324-1001.2	3324-2001.2	4.0							
3324-1001.25	3324-2001.25	4.3							
3324-1001.3	3324-2001.3	4.6							
3324-1001.35	3324-2001.35	5.0							
3324-1001.4	3324-2001.4	5.3							
3324-1001.45	3324-2001.45	5.6							
3324-1001.5	3324-2001.5	6.0							

Hypro Part Number		Nozzle Capacity (GPM) at Pump Pressure (PSI)														
Variable	Hi-Lo Variable	Nozzle No.	Orifice Diameter		PSI											GPM
			mm	inches	600	700	800	900	1000	1200	1500	1800	2000	2500	3000	
3324-1000.85	3324-2000.85	2.0	.085	.033	.077	0.80	.089	.095	1.00	1.10	1.20	1.35	1.40	1.40	.033	
3324-1001.05	3324-2001.05	3.0	1.05	.041	1.22	1.30	1.37	1.45	1.52	1.66	1.86	2.04	2.16	2.42	2.64	
3324-1001.1	3324-2001.1	3.5	1.10	.043	1.35	1.43	1.52	1.60	1.68	1.84	2.06	2.26	2.39	2.67	2.91	
3324-1001.15	3324-2001.15	3.7	1.15	.045	1.55	1.63	1.72	1.80	1.88	2.03	2.25	2.46	2.59	2.90	3.17	
3324-1001.2	3324-2001.2	4.0	1.20	.047	1.60	1.70	1.80	1.90	2.00	2.19	2.45	2.69	2.84	3.17	3.44	
3324-1001.25	3324-2001.25	4.3	1.25	.049	1.72	1.83	1.94	2.05	2.16	2.36	2.64	2.90	3.06	3.41	3.70	
3324-1001.3	3324-2001.3	4.6	1.30	.051	1.85	1.97	2.09	2.21	2.32	2.54	2.84	3.12	3.29	3.66	3.96	
3324-1001.35	3324-2001.35	5.0	1.35	.053	1.97	2.10	2.23	2.36	2.48	2.71	3.04	3.34	3.52	3.92	4.23	
3324-1001.4	3324-2001.4	5.3	1.40	.055	2.09	2.23	2.37	2.50	2.63	2.89	3.23	3.55	3.74	4.16	4.49	
3324-1001.45	3324-2001.45	5.6	1.45	.057	2.22	2.37	2.52	2.66	2.80	3.06	3.43	3.77	3.97	4.41	4.79	
3324-1001.5	3324-2001.5	6.0	1.50	.059	2.34	2.50	2.66	2.81	2.96	3.24	3.63	3.99	4.20	4.66	5.02	

Note: Capacity figures shown are with water at 70°F. There may be variations due to power supply, temperature, viscosity, additives, etc.

# Measurement Components

## Orion® Flowmeters

New digital technology converts fluid ion flow into gpm/lpm, virtually making mechanical flowmeters obsolete. These precise flowmeters work by utilizing sensors to relay pulse signals and converting them into gpm/lpm readings. The Visual-Flow flowmeter, with touch pad, displays instant flow reading for quantity of fluid filled.



- No mechanical moving parts
- Advanced technology at an affordable price
- Performance independent from fluid density and viscosity
- Low sensitivity to turbulence
- Wide variety of flows for use in diverse applications
- High precision, typical error is 0.5%
- Pulse output is 0-12 volts, max. consumption of 300 mA (milliamps)
- Accuracy and precision saves chemical throughout the life of the system
- Working pressure up to 580 psi (40 bar)
- Integrates with existing rate controllers
- AMP® Super Seal™ connection

### 1-Visual-Flow Flowmeter With Male Thread Adapters

Part Number	Part Number	Flow (GPM)	Flow (L/min)	Size	Max PSI	Max BAR
4621BA01313	-	0.13 -2.6	.5-10	3/4"	290	20
4621BA11313	-	0.3 - 5	1-20	3/4"	290	20
4621BA41414	-	2.6 - 53	10-200	1"	290	20
4622BA51616	464622BA51616	5 - 106	20-400	1-1/2"	290	20
4622BA61717	464622BA61717	8 - 158	30-600	2"	290	20

Available for order through HYPRO-EU only (Cambridge, UK)

### 2-Orion Flowmeter With Male Thread Adapters

Part Number	Part Number	Flow (GPM)	Flow (L/min)	Size	Max PSI	Max BAR
4621AA11313	-	.3 - 5	1-20	3/4"	290	20
4621AA31414	-	1.4 - 26	5-100	1"	290	20
4621AA41414	-	2.6 - 53	10-200	1"	290	20
4621AA41515	-	2.6 - 53	10-200	1-1/4"	290	20
4622AA51616	464622AA51616	5 - 106	20-400	1-1/2"	290	20
4622AA61717	464622AA61717	8 - 158	30-600	2"	290	20

Available for order through HYPRO-EU only (Cambridge, UK)

### 3-Orion Flowmeter Only

Part Number	Part Number	Flow (GPM)	Flow (L/min)	Max PSI	Max BAR	Adapter Series
4621AA10000	464621AA10000	0.3 - 5	1-20	580	40	463
4621AA20000	464621AA20000	0.6 - 13	2-50	580	40	463
4621AA30000	464621AA30000	1.3 - 26	5-100	580	40	463
4621AA40000	464621AA40000	2.6 - 53	10-200	580	40	463
4622AA40000	-	2.6 - 53	10-200	580	40	473
4622AA50000	-	5 - 106	20-400	580	40	473

Bolt Kit, V1M258-FM, includes stainless steel bolts, washers and lock nuts.

Available for order through HYPRO-EU only (Cambridge, UK)

### Adapter Cables

Part Number	Reference Number	Description
AE2650	<b>A</b>	Orion to Raven® (Conxall®)
AE2651	<b>B</b>	Orion to TeeJet® (Deutsch®)
AE2652	<b>C</b>	Orion to John Deere (Packard®)
AE2654	<b>D</b>	Orion to MidTech (Packard Weather Pack®)
4622BA50000-100	*	4 pin, 10' extension cable (Visual-Flow)*
4622BA50000-200	*	4 pin cable w/pump stop unit (Visual-Flow)*
4621AA10000-100	*	3 pin, 10' extension cable (Orion)*

\*Not shown.

Orion® is a registered trademark of ARAG.

Raven® is a registered trademark of Raven Industry

Conxall® is a registered trademark of Conxall Corp.

TeeJet® is a registered trademark of Spraying Systems Co.

Packard® is a registered trademark of Delphi

Packard Weather Pack® is a registered trademark of Delphi

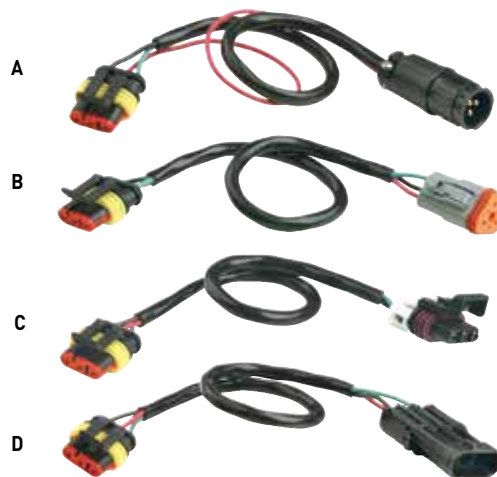

# ARAG<sup>®</sup> Sprayer Control Valves



## Electric Proportional Spray Control Valves

Part Number	Part Number	Series	Max.GPM*	Max.PSI*	Open to Close	Outlet Size
463020	46463020	863	12	580	14 seconds	3/4" HB
8630020S	-	863	12	580	7 seconds	3/4" HB
8630024S	46463024	863	12	580	14 seconds	3/4" HB
8630D24S	-	863	12	580	14 seconds	3/4" HB

\* Max GPM per valve section.

Available for order through HYPRO-EU only (Cambridge, UK)



## Electric 3-Wire Boom Section Valve

Part Number	Series	Max.GPM*	Max.PSI*	Open to Close	Outlet Size
8630001	463/863	12	290	0.6 seconds	1/2" HB
8630011**	463/863	12	290	0.6 seconds	3/4" HB

\* Max GPM per valve section. \*\*Includes bypass port.



Part Number	Part Number	Series	Max.GPM*	Max.PSI*	Outlet Size
473070	46473070	473	31	580	1 1/4" HB

\* Max GPM per valve section.

Available for order through HYPRO-EU only (Cambridge, UK)



## Manual Pressure Regulating Valves

Part Number	Series	Max.GPM*	Max.PSI*	Outlet Size
463080N	463	12	290	3/4" HB

\* Max GPM per valve section.



## Manual Boom Section Valves

Part Number	Part Number	Series	Max.GPM*	Max.PSI*	Metered Bypass	Outlet Size
463051	46463051	463	12	290	No	3/4" HB
463061	46463061	463	12	290	Yes	3/4" HB

\* Max GPM per valve section.

Available for order through HYPRO-EU only (Cambridge, UK)



## Series 461 - Economic Manual Valve Assemblies

Part Number	Valves*	Max.GPM*	Max.PSI*	Inlet Size	Outlet Size	Regulator
461031-1	3	12	290	1" HB	1/2" HB	No
461031-2	3	12	290	1" HB	3/4" HB	No
461031-3	3	12	290	1/2" HB	1/2" HB	No
461031-4	3	12	290	1" HB	1/2" HB	Yes
461021-1	2	12	290	1" HB	1/2" HB	No
9950-0030	3	12	290	**	**	Yes

\*Includes flynut inlet and hose barb outlets in sizes indicated.

\*\*Supplied with 3/4" elbow HB, 3/4" straight HB and 1/2" straight HB inlets and 3/4" FNPT, 3/4" HB, 1/2" HB and 3/8" HB outlets.

Arag<sup>®</sup> is a registered trademark of ARAG.  
Hypro<sup>®</sup> is a registered trademark of Pentair.



### Electric Proportional Spray Control Valves

Part Number	Max.GPM	Max.PSI	Open to Close	Outlet Size
3470-0104	26	580	7 seconds	Outlet port sold separately (See below)



### Electric 3-Wire Boom Section Valves

Part Number	Max.GPM	Max.PSI	Open to Close	Metered Bypass	Outlet Size
3470-0106	12	290	0.2 seconds	Yes	Outlet port sold separately (See below)
3470-0101	12	290	0.2 seconds	No	Outlet port sold separately (See below)



### Manual Proportional Spray Control Valves

Part Number	Max.GPM	Max.PSI	Outlet Size
3470-0103	26	580	3/4" HB



### Manual Pressure Regulating Valves

Part Number	Max.GPM	Max.PSI	Outlet Size
3470-0102	26	290	Outlet port sold separately (See below)



### Manual Boom Section Valves

Part Number	Max.GPM	Max.PSI	Outlet Size
3470-0107	12	290	Outlet port sold separately (See below)

### Outlet Ports for Valves

Part Number	Max.GPM	Max.PSI	Outlet Size
3470-0206	12	290	3/8" HB
3470-0201	12	290	1/2" HB
3470-0202	12	290	3/4" HB
3470-0204	12	290	1" HB
3470-0203	12	290	3/4" FNPT
3470-0207	12	290	1/2" HB-90° Elbow



# HYPRO<sup>®</sup> Sprayer Control Valves



## Replacement Clips & O-rings

Part Number	Description
3470-0208	Replacement O-ring
3470-0209	Replacement clip



## Valve Inlet Male Adapters

Part Number	Description	Ref #
3470-0305	Adapter Female Side Male 3/4" BSP	-
3470-0306	Adapter Female Side Male 1" BSP	-
3470-0307	Adapter Male Side Male 3/4" BSP	-
3470-0308	Adapter Male Side Male 1" BSP	-
3470-0301	Adapter Female Side Female 3/4" NPT	1
3470-0302	Adapter Female Side Female 1" NPT	1
3470-0401	Adapter Male Side Female 3/4" NPT	2
3470-0402	Adapter Male Side Female 1" NPT	2
3470-0403	Male End Cap	3
3470-0303	Female End Cap	3



## Bolts, Kits and Mounting Brackets

Part Number	Description
3470-0601	1 Section stainless steel
3470-0605	2 Section stainless steel
3470-0603	3 Section stainless steel
3470-0602	4 Section stainless steel
3470-0604	5 Section stainless steel





### Metered Bypass Manifolds

Part Number	Description
3470-0500	3 Section



### Metered Bypass Parts

Part Number	Description
3470-0900	Cap
3470-0901	Clip



### Flanged Line Strainer

Part Number	Description
3470-0800	Self Cleaning, 50 Mesh



### Replacement Screens for Flanged Line Strainer

Part Number	Description
3470-0801	50 Mesh



### Cables

Part Number	Description
3470-0700	2 wire- 4' cable w/ gasket and screw
3470-0708	3 wire- 4' cable w/ gasket and screw
3470-0702	Din connector w/ gasket and screw

# Ball Valves

- Fiberglass-reinforced polypropylene body for strength and chemical resistance
- Teflon seats for smooth operation and proper sealing characteristics
- EPDM O-rings to handle most fertilizers and chemicals
- Max. operating pressure for sizes up to 1-1/4" – 232 PSI (16 bar). For 1-1/2" and 2" – 145 PSI (10 bar).



## Single Union Ball Valves - 2 Way

NPT Part Number	BSP Part Number	Part Number	Size	Mounting Inserts	Max PSI	Max BAR
9951-2050N	9951-2050B	56454132	1/2"	None	232	16
9951-2075N	9951-2075B	56454133	3/4"	None	232	16
9951-2100N	9951-2100B	56454134	1"	None	232	16
9951-2125N	9951-2125B	56454135	1-1/4"	8 mm	145	10
9951-2150N	9951-2150B	56454136	1-1/2"	8 mm	145	10
9951-2200N	9951-2200B	56454137	2"	8 mm	145	10

Available for order through HYPRO-EU only (Cambridge, UK)



## Single Union Ball Valves - 3 Way

NPT Part Number	BSP Part Number	Part Number	Size	Mounting Inserts	Max PSI	Max BAR
9951-3050N	9951-3050B	56454232	1/2"	None	232	16
9951-3075N	9951-3075B	56454233	3/4"	None	232	16
9951-3100N	9951-3100B	56454234	1"	None	232	16
9951-3125N	9951-3125B	56454235	1-1/4"	8 mm	145	10
9951-3150N	9951-3150B	56454236	1-1/2"	8 mm	145	10
9951-3200N	9951-3200B	56454237	2"	8 mm	145	10

Available for order through HYPRO-EU only (Cambridge, UK)



## Anti-Backflow Valves

Part Number	MBSP x MBSP	Length
5042015	1-1/4" x 1-1/4"	4.13" / 105 mm
5042016	1-1/2" x 1-1/2"	4.37" / 111 mm
5042017	2" x 2"	4.96" / 126 mm
5042019	3" x 3"	6.02" / 153 mm



## Check Valves

Part Number	MNPT x MNPT	Material	Cracking Pressure PSI	Cracking Pressure BAR
3320-0065	1/2" X 1/2"	Polypropylene	3	.20



## Shut-Off Valves

Part Number	MGHT (inlet) x MGHT	Material
3305-0112	1/2" X 1/2"	Polypropylene



## Garden Hose Shut-Off Valve

Part Number	FGHT (inlet) x MGHT	Type	Description	Max. PSI	Max BAR
LA5	3/4" X 3/4"	1-Way	Cyclac body and ball with Buna-N seals suitable for outdoor use	75	5
LA24	3/4" X [2] 3/4"	2-Way		75	5



## Polypropylene Ball Valve

Part Number	Size	Max. PSI*	Max. BAR	Material	O-ring Material
15-14	1/4" X 1/4"	25	3.4	Polypropylene	EPDM

\*Max psi for liquids compatible with polypropylene and EPDM.

# Ball Valves



## Series 90 – Plated Brass Ball Valve

Part Number	Size	Handle Type	Max PSI	Max BAR	Max. Temp	
					US Units	Metric Units
90FFB18	1/8" FNPT X 1/8" FNPT	Butterfly	300	20	212° F	100° C
90FFB14	1/4" FNPT X 1/4" FNPT	Butterfly	300	20	212° F	100° C
90FMB14	1/4" FNPT X 1/4" MNPT	Butterfly	300	20	212° F	100° C
90FFB38	3/8" FNPT X 3/8" FNPT	Butterfly	300	20	212° F	100° C
90FMB38	3/8" FNPT X 3/8" MNPT	Butterfly	300	20	212° F	100° C
90FFB12	1/2" FNPT X 1/2" FNPT	Butterfly	300	20	212° F	100° C
90FMB12	1/2" FNPT X 1/2" MNPT	Butterfly	300	20	212° F	100° C
90FFL18	1/8" FNPT X 1/8" FNPT	Lever	300	20	212° F	100° C
90FFL14	1/4" FNPT X 1/4" FNPT	Lever	300	20	212° F	100° C
90FML14	1/4" FNPT X 1/4" MNPT	Lever	300	20	212° F	100° C
90FFL38	3/8" FNPT X 3/8" FNPT	Lever	300	20	212° F	100° C
90FML38	3/8" FNPT X 3/8" MNPT	Lever	300	20	212° F	100° C
90FFL12	1/2" FNPT X 1/2" FNPT	Lever	300	20	212° F	100° C
90FML12	1/2" FNPT X 1/2" MNPT	Lever	300	20	212° F	100° C
90-HBF	Replacement nylon butterfly handle					
RI167	Replacement nylon lever handle					

## Full Port Brass and 316 Stainless Steel Ball Valves



Part Number	Material	Size	Max PSI	Max Bar	Max. Temp.	
					US Units	Metric Units
171N-14	Brass	1/4" FNPT	600	41	320° F	160° C
171N-38	Brass	3/8" FNPT	600	41	320° F	160° C
171N-12	Brass	1/2" FNPT	600	41	320° F	160° C
171N-34	Brass	3/4" FNPT	600	41	320° F	160° C
171N-100	Brass	1" FNPT	600	41	320° F	160° C
171N-114	Brass	1 1/4" FNPT	600	41	320° F	160° C
171N-112	Brass	1 1/2" FNPT	600	41	320° F	160° C
171N-200	Brass	2" FNPT	600	41	320° F	160° C
78-14	316 Stainless Steel	1/4" FNPT	1000	69	320° F	160° C
78-38	316 Stainless Steel	3/8" FNPT	1000	69	320° F	160° C
78-12	316 Stainless Steel	1/2" FNPT	1000	69	320° F	160° C
78-34	316 Stainless Steel	3/4" FNPT	1000	69	320° F	160° C
78-100	316 Stainless Steel	1" FNPT	1000	69	320° F	160° C
78-114	316 Stainless Steel	1 1/4" FNPT	1000	69	320° F	160° C
78-112	316 Stainless Steel	1 1/2" FNPT	1000	69	320° F	160° C
78-200	316 Stainless Steel	2" FNPT	1000	69	320° F	160° C
78-300	316 Stainless Steel	3" FNPT	1000	69	320° F	160° C

10-32 threaded mounting holes.  
Teflon seals and o-rings.

# Gauges

## Dual-Scale Glycerin-Filled 2-1/2" Gauges (Stainless Steel Case)



- Movement: Brass
- Bourdon Tube: Phosphor bronze
- Pointer: Black-enameled aluminum
- Dial: White background
- Window: Acrylic
- Liquid Fill: 99.5% pure virgin Glycerin
- Connection: 1/4" NPT Brass connection
- Accuracy: ASME/ANSI B40.1 Grade B (3-2-3%)

This series is designed for use with air, gas, oil, and water or any medium not corrosive to brass or bronze. Liquid-filled gauges are recommended for reducing shock waves caused by pressure or vibration fluctuations.

### Order Information

Part Number	Pressure Reading Range	Face Size		Stem Size	Estimated Weight Ea.	
		US Units	Metric Units		US Units	Metric Units
2640-0009	0-60 psi/4 BAR	2-1/2"	65 mm	1/4" NPT (M)	7.5 oz.	213 g
2640-0010	0-100 psi/7 BAR					
2640-0011	0-200 psi/14 BAR					
2640-0007	0-300 psi/21 BAR					
2640-0008	0-600 psi/42 BAR					
2640-0001	0-1000 psi/70 BAR					
2640-0002	0-1500 psi/105 BAR					
2640-0003	0-2000 psi/140 BAR					
2640-0004	0-3000 psi/210 BAR					
2640-0005	0-5000 psi/350 BAR					
2640-0014	0-10000 psi/700 BAR					

# Gauges

## SG Series Dry 1-1/2", 2", 2-1/2" and 4" Gauges



PSI only Plastic case

This series is designed for use with air, gas, oil, and water or any medium not corrosive to brass or bronze.

- Movement: Brass
- Bourdon Tube: C Shaped in copper alloy up to 600 psi and Helical in phosphor bronze over 600 psi
- Pointer: Black-enameled aluminum
- Dial: White aluminum
- Window: Acrylic
- Connection: 1/8" NPT male standard on 1-1/2" size  
1/4" NPT standard on 2", 2-1/2", & 4" sizes
- Accuracy: ASME/ANSI B40.1 Grade B (3-2-3%)

## Order Information

Part Number	PSI Range	Dial Size	Stem Size
SG601.58C SG1001.58C SG1601.58C SG2001.58C	0-60 0-100 0-160 0-200	1-1/2"	1/8" CBM
SG602C SG1002C SG1602C SG2002C SG3002C	0-60 0-100 0-160 0-200 0-300	2"	1/4" CBM
SG152 SG302 SG602 SG1002 SG1602 SG2002 SG3002	0-15 0-30 0-60 0-100 0-160 0-200 0-300	2"	1/4" LM
SG15 SG30 SG60 SG100 SG160 SG200 SG300 SG400 SG600 SG1000 SG2000 SG3000 SG5000	0-15 0-30 0-60 0-100 0-160 0-200 0-300 0-400 0-600 0-1000 0-2000 0-3000 0-5000	2-1/2"	1/4" LM
SG604 SG1004 SG2004	0-60 0-100 0-200	4"	1/4" LM

## GG Series Glycerin-Filled 2-1/2" and 4" Gauges



PSI only  
304 Stainless Steel Case

This series is designed for use with air, gas, oil, and water or any medium not corrosive to brass or bronze. Liquid-filled gauges are recommended for reducing shock waves caused by pressure or vibration fluctuations.

- Movement: Brass
- Bourdon Tube: Phosphor bronze
- Pointer: Black-enameled aluminum
- Dial: White background
- Window: Acrylic
- Liquid Fill: 99.5% pure virgin Glycerin
- Connection: 1/4" NPT Brass connection
- Accuracy: ASME/ANSI B40.1 Grade B (3-2-3%)

## Order Information

Part Number	PSI Range	Dial Size	Stem Size
WGG60C WGG100C WGG160C WGG200C WGG300C WGG400C WGG600C WGG1000C WGG1500C WGG2000C WGG3000C WGG5000C WGG6000C	0-60 0-100 0-160 0-200 0-300 0-400 0-600 0-1000 0-1500 0-2000 0-3000 0-5000 0-6000	2-1/2"	1/4" CBM & U-clamp
GG30 GG60 GG100 GG160 GG200 GG300 GG400 GG600 GG1000 GG1500 GG2000 GG3000 GG4000 GG5000 GG6000	0-30 0-60 0-100 0-160 0-200 0-300 0-400 0-600 0-1000 0-1500 0-2000 0-3000 0-4000 0-5000 0-6000	2-1/2"	1/4" LM
GG10000 GG15000	0-10000 0-15000	2-1/2"	1/4" LM
VGG30 VGG3030 VGG3060 VGG30160	VAC / 30 Hg 0-30 psi / 30 Hg 0-60 psi / 30 Hg 0-160 psi / 30 Hg	2-1/2"	1/4" LM
GG604 GG1004	0-60 0-100	4"	1/4" LM
VGG30604	0-60 psi / 30 Hg	4"	1/4" LM

# Gauges

## ASG Series Dry 2-1/2" and 4" Gauges for Ammonia



2-1/2" and 4" Gauges  
Single Scale - PSI only  
Enameled steel case

This series is designed especially for use with ammonia.

- Movement: Stainless Steel tube
- Bourdon Tube: 316 Stainless Steel
- Pointer: Black-enameled aluminum
- Dial: White background
- Window: Polycarbonate
- Connection: 1/4" NPT Standard
- Accuracy: ASME/ANSI B40.1 Grade B (3-2-3 %)

## WGGSS Series Glycerin-Filled 2-1/2" Gauges



PSI only

This series is designed for use with air, gas, oil, and water or any medium not corrosive to stainless steel. Liquid-filled gauges are recommended for reducing shock waves caused by pressure or vibration fluctuations.

- Movement: Stainless Steel
- Bourdon Tube: 316 Stainless Steel
- Pointer: Black-enameled aluminum
- Dial: White background
- Window: Polycarbonate
- Liquid Fill: 99.5% pure virgin Glycerin
- Connection: 1/4" NPT Stainless Steel connection  
2-1/2" gauges
- Accuracy: 2-1/2" - ASME/ANSI B40.1 Grade A (2-1-2 %)

## Accessories

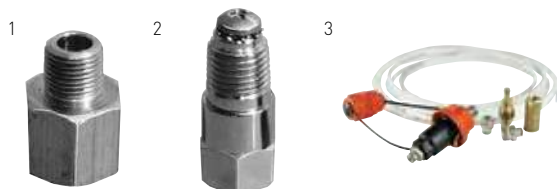

## Order Information

Part Number	PSI Range	Dial Size	Stem Size
ASG60	0-60	2-1/2"	1/4" LM
ASG160	0-160	2-1/2"	1/4" LM
ASG400	0-400	2-1/2"	1/4" LM
ASG604	0-60	4"	1/4" LM
ASG1604	0-160	4"	1/4" LM
ASG4004	0-400	4"	1/4" LM

Replacement lens AF available.

## Order Information

Part Number	PSI Range	Dial Size	Stem Size
WGGSS100C	0-100	2-1/2"	1/4" CBM
WGGSS400C	0-400		
WGGSS60	0-60	2-1/2"	1/4" LM
WGGSS100	0-100		
WGGSS160	0-160		
WGGSS400	0-400		
WGGSS600	0-600		
WGGSS1000	0-1000		
WGGSS3000	0-3000		
WGGSS5000	0-5000		

## Order Information

Reference Number	Part Number	Description
1	MF1814B	Reducing Coupler 1/4" FNPT x 1/8" MNPT
2	B301AB	1/4" Gauge Dampener
3	3470-0205	Universal Isolator Kit

# Universal Flanged Clamps



- Clamshell design delivers superior durability and sealing capability through an even clamping pressure around Universal Flange joints
- GTX polymer delivers superior chemical resistance and strength
- Captured bolt and nut design allows for ease of assembly and maintenance, with 10mm socket or nut driver
- Servicable design eliminates areas prone to collecting debris and excessive corrosion

Size		Fits Series	Max. Operating Pressure		Packaging	UF Clamps w/ Stainless Steel Hardware
US Units	Metric Units		at 70°F	at 21°C		Part Number
1"	25 mm	100	150 PSI	10 BAR	1 Clamp & 1 Gasket	BG-UFC0100E-A-S
					Clamp only	UFC0100-S
1.5"	38 mm	200	150 PSI	10 BAR	1 Clamp & 1 Gasket	BG-UFC0150E-A-S
					Clamp only	UFC0150-S
2"	51 mm	220	150 PSI	10 BAR	1 Clamp & 1 Gasket	BG-UFC0200E-A-S
					Clamp only	UFC0200-S
3"	76 mm	300	125 PSI	8.6 BAR	1 Clamp & 1 Gasket	BG-UFC0300E-A-S
					Clamp only	UFC0300-S

# Universal Flanged Gaskets



- The gasket wraparound feature provides positive alignment of the adjoining fittings and allows visual inspection to be conducted during assembly
- Provides sealing areas between fitting faces and outside diameter of flanged surfaces which increases the maximum pressure the joint can manage without leaks
- Flow can be increased by as much as 16% as the new universal flanged gasket reduces protrusion into the joint

Part Number	Size		Fits Series	Gasket Type
	US Units	Metric Units		
UFG0100E-A	1"	25 mm	100	EPDM
UFG0150E-A	1.5"	38 mm	200	EPDM
UFG0200E-A	2"	51 mm	220	EPDM
UFG0300E-A	3"	76 mm	300	EPDM

# Universal Flange Fittings and Valves

## Universal Flange Size Reference

Hypro Part Number Series	UF100	Not Available	UF200	UF300
UF Series	100	200	220	300
US Units	1"	1.5"	2"	3"
Metric Units	25 mm	38 mm	51 mm	76 mm
Maximum Operating Pressure @ 70° F (21° C)	150 PSI (10 BAR)	N/A	150 PSI (10 BAR)	125 PSI (8.5 BAR)

## Universal Flange Couplings



Part Number	Size	Fit Series	Description	Max. Operating Pressure	
				at 70°F	at 21°C
UF100	1"	100	Coupling, Flange	150 PSI	10 BAR
UF200	2"	220	Coupling, Flange	150 PSI	10 BAR
UF300	3"	300	Coupling, Flange	125 PSI	8.6 BAR

## Universal Flange Elbows



Part Number	Size	Fit Series	Description	Max. Operating Pressure	
				at 70°F	at 21°C
UF100L	1"	100	Elbow, Flange	150 PSI	10 BAR
UF200L	2"	220	Elbow, Flange	150 PSI	10 BAR
UF300L	3"	300	Elbow, Flange	125 PSI	8.6 BAR

## Universal Flange Tees



Part Number	Size	Fit Series	Description	Max. Operating Pressure	
				at 70°F	at 21°C
UF100T	1"	100	Tee, Flange	150 PSI	10 BAR
UF200T	2"	220	Tee, Flange	150 PSI	10 BAR
UF300T	3"	300	Tee, Flange	125 PSI	8.6 BAR

# Universal Flange Fittings and Valves

## Universal Flange Crosses



Part Number	Size	Fit Series	Description	Max. Operating Pressure	
				at 70°F	at 21°C
UF100X	1"	100	Cross, Flange	150 PSI	10 BAR
UF200X	2"	220	Cross, Flange	150 PSI	10 BAR
UF300X	3"	300	Cross, Flange	125 PSI	8.6 BAR

## Universal Flange Reducing Coupling



Part Number	Size	Fit Series	Description	Max. Operating Pressure	
				at 70°F	at 21°C
UF200-RC100	2" x 1"	220 x100	Reducing Coupling Flange x Flange	150 PSI	10 BAR
UF300-RC200	3" x 2"	300 x220	Reducing Coupling Flange x Flange	125 PSI	8.6 BAR

## Universal Flange x Hose Bar



Part Number	Size (UF X HB)	Fit Series	Description	Max. Operating Pressure	
				at 70°F	at 21°C
UF100-HB075	1" x 3/4"	100	Flange x HB	150 PSI	10 BAR
UF100-HB100	1" x 1"	100	Flange x HB	150 PSI	10 BAR
UF100-HB125	1" x 1-1/4"	100	Flange x HB	150 PSI	10 BAR
UF200-HB150	2" x 1-1/2"	220	Flange x HB	150 PSI	10 BAR
UF200-HB200	2" x 2"	220	Flange x HB	150 PSI	10 BAR
UF300-HB200	3" x 2"	300	Flange x HB	125 PSI	8.6 BAR
UF300-HB300	3" x 3"	300	Flange x HB	125 PSI	8.6 BAR

## Universal Flange Elbow x Hose Barbs



Part Number	Size (UF X HB)	Fit Series	Description	Max. Operating Pressure	
				at 70°F	at 21°C
UF100L-HB075	1" x 3/4"	100	Elbow, Flange x HB	150 PSI	10 BAR
UF100L-HB100	1" x 1"	100	Elbow, Flange x HB	150 PSI	10 BAR
UF100L-HB125	1" x 1-1/4"	100	Elbow, Flange x HB	150 PSI	10 BAR
UF150L-HB125	1" x 1.25"	150	Elbow, Flange x HB	150 PSI	10 BAR
UF200L-HB150	2" x 1-1/2"	220	Elbow, Flange x HB	150 PSI	10 BAR
UF200L-HB200	2" x 2"	220	Elbow, Flange x HB	150 PSI	10 BAR
UF300L-HB200	3" x 2"	300	Elbow, Flange x HB	125 PSI	8.6 BAR
UF300L-HB300	3" x 3"	300	Elbow, Flange x HB	125 PSI	8.6 BAR

## Universal Flange x Hose Barb Tee



Part Number	Size (UF x FNPT)	Fit Series	Description	Max. Operating Pressure	
				at 70°F	at 21°C
UF100-HBT100	1" x 1"	100	Flange x HBT	150 PSI	10 BAR

## Universal Flange x Male Pipe Thread



Part Number	Size (UF X MNPT)	Fit Series	Description	Max. Operating Pressure	
				at 70°F	at 21°C
UF100-MN075	1" x 3/4"	100	Flange x MNPT	150 PSI	10 BAR
UF100-MN100	1" x 1"	100	Flange x MNPT	150 PSI	10 BAR
UF100-MN125	1" x 1-1/4"	100	Flange x MNPT	150 PSI	10 BAR
UF200-MN200	2" x 2"	220	Flange x MNPT	150 PSI	10 BAR
UF300-MN300	3" x 3"	300	Flange x MNPT	125 PSI	8.6 BAR

## Universal Flange x Female Pipe Thread



Part Number	Size (UF x FNPT)	Fit Series	Description	Max. Operating Pressure	
				at 70°F	at 21°C
UF100-FN100	1" x 1"	100	Flange x FNPT	150 PSI	10 BAR
UF200-FN200	2" x 2"	220	Flange x FNPT	150 PSI	10 BAR

## Universal Flange x Male Camlock Adapter



Part Number	Size	Fit Series	Description	Max. Operating Pressure	
				at 70°F	at 21°C
UF200-MA200	2" x 2"	220	Flange x Male Coupler Camlock	150 PSI	10 BAR
UF300-MA300	3" x 3"	300	Flange x Male Coupler Camlock	125 PSI	8.6 BAR

## Universal Flange Plug x Flange



Part Number	Size	Fit Series	Description	Max. Operating Pressure	
				at 70°F	at 21°C
UF100P	1" x 1"	100	Plug, Flange	150 PSI	10 BAR
UF200P	2" x 2"	220	Plug, Flange	150 PSI	10 BAR
UF300P	3" x 3"	300	Plug, Flange	125 PSI	8.6 BAR
UF100-FN025P	1" w/ 1/4" FPT	100	Plug, Flange w/FPT	150 PSI	10 BAR

## Universal Flange Bolted Ball Valves



Part Number	Size	Fit Series	Description	Max. Operating Pressure	
				at 70°F	at 21°C
9951-2100UF	1"	100	Bolted Ball Valve with flange connections	150 PSI	10 BAR
9951-2200UF	2"	220	Bolted Ball Valve with flange connections	150 PSI	10 BAR
9951-2300UF	3"	300	Bolted Ball Valve with flange connections	125 PSI	8.6 BAR

# Hose Barb with Fly Nut & O-Ring



## Straight Hose Barb with Fly Nut and O-Ring

Part Number	O-Ring Groove x Hose Barb	
	US Units	Metric Units
FNAS-1212	1/2 inch x 1/2 inch	13 mm x 13 mm
FNAS-3412	3/4 inch x 1/2 inch	19 mm x 13 mm
FNAS-3458	3/4 inch x 5/8 inch	19 mm x 16 mm
FNAS-3434	3/4 inch x 3/4 inch	19 mm x 19 mm
FNAS-10012	1 inch x 1/2 inch	25 mm x 13 mm
FNAS-10034	1 inch x 3/4 inch	25 mm x 19 mm
FNAS-100100	1 inch x 1 inch	25 mm x 25 mm
FNAS-114100	1-1/4 inch x 1 inch	32 mm x 25 mm
FNAS-114114	1-1/4 inch x 1-1/4 inch	32 mm x 32 mm
FNAS-112100	1-1/2 inch x 1 inch	38 mm x 25 mm
FNAS-112114	1-1/2 inch x 1-1/4 inch	38 mm x 32 mm
FNAS-112112	1-1/2 inch x 1-1/2 inch	38 mm x 38 mm
FNAS-200200	2 inch x 2 inch	50 mm x 50 mm

## Elbow Hose Barb with Fly Nut and O-Ring



Part Number	O-Ring Groove x Hose Barb	
	US Units	Metric Units
FNAE-3412	3/4 inch x 1/2 inch	19 mm x 13 mm
FNAE-3458	3/4 inch x 5/8 inch	19 mm x 16 mm
FNAE-3434	3/4 inch x 3/4 inch	19 mm x 19 mm
FNAE-10034	1 inch x 3/4 inch	25 mm x 19 mm
FNAE-100100	1 inch x 1 inch	25 mm x 25 mm
FNAE-114100	1-1/4 inch x 1 inch	32 mm x 25 mm
FNAE-114114	1-1/4 inch x 1-1/4 inch	32 mm x 32 mm
FNAE-112100	1-1/2 inch x 1 inch	38 mm x 25 mm
FNAE-112114	1-1/2 inch x 1-1/4 inch	38 mm x 32 mm
FNAE-112112	1-1/2 inch x 1-1/2 inch	38 mm x 38 mm
FNAE-200200	2 inch x 2 inch	50 mm x 50 mm

All assemblies include same size fly nut and o-ring.

## Blanking CAPS



Part Number	CAP-BPS Threads
2102020	1/2"
2102030	3/4"
FNCAP-100	1"

# Fittings - Cam Locks

## Stainless Steel and Polypropylene Cam Lock Couplings

### A. Male Adapter / Female Thread



A

Stainless Steel	Coupling Size	Thread Size	NPT Poly	BSP Poly	BSP Poly
A-750SS	3/4 inch	3/4 inch	9950-075NA	9950-075BA	02075A34
A-100SS	1 inch	1 inch	9950-100NA	9950-100BA	02100A10
-	1-1/4 inch	1-1/4 inch	9950-125NA	9950-125BA	02125A54
A-150SS	1-1/2 inch	1-1/2 inch	9950-150NA	9950-150BA	02150A64
A-200SS	2 inch	2 inch	9950-200NA	9950-200BA	02200A20
A-300SS	3 inch	3 inch	9950-300NA	9950-300BA	02300A30

Available for order through HYPRO-EU only (Cambridge, UK)



A

### B. Female Coupler / Male Thread



B

Stainless Steel	Coupling Size	Thread Size	NPT Poly	BSP Poly	BSP Poly
B-750SS	3/4 inch	3/4 inch	9950-075NB	9950-075BB	02075B34
B-100SS	1 inch	1 inch	9950-100NB	9950-100BB	02100B10
-	1-1/4 inch	1-1/4 inch	9950-125NB	9950-125BB	02125B54
B-150SS	1-1/2 inch	1-1/2 inch	9950-150NB	9950-150BB	02150B64
B-200SS	2 inch	2 inch	9950-200NB	9950-200BB	02200B20
B-300SS	3 inch	3 inch	9950-300NB	9950-300BB	02300B30

Available for order through HYPRO-EU only (Cambridge, UK)



B

### C. Female Coupler / Hose Fitting



C

Stainless Steel	Coupling Size	Barb Size	Poly	Poly
C-750SS	3/4 inch	3/4 inch	9950-075C	02075C34
C-100SS	1 inch	1 inch	9950-100C	02100C10
-	1-1/4 inch	1-1/4 inch	9950-125C	02125C54
C-150SS	1-1/2 inch	1-1/2 inch	9950-150C	02150C64
C-200SS	2 inch	2 inch	9950-200C	02200C20
C-300SS	3 inch	3 inch	9950-300C	02300C30

Available for order through HYPRO-EU only (Cambridge, UK)



C



# Fittings - Cam Locks

## Stainless Steel and Polypropylene Cam Lock Couplings

### D. Female Coupler / Female Thread



D

Stainless Steel	Coupling Size	Thread Size	Poly	BSP Poly	BSP Poly
-	3/4 inch	1/2 inch	18103D2N	-----	02050D12
D-750SS	3/4 inch	3/4 inch	9950-075ND	9950-075BD	02075D34
D-100SS	1 inch	1 inch	9950-100ND	9950-100BD	02100D10
-	1-1/4 inch	1-1/4 inch	9950-125ND	9950-125BD	02125D54
D-150SS	1-1/2 inch	1-1/2 inch	9950-150ND	9950-150BD	02150D64
D-200SS	2 inch	2 inch	9950-200ND	9950-200BD	02200D20
D-300SS	3 inch	3 inch	9950-300ND	9950-300BD	02300D30



D

Available for order through HYPRO-EU only (Cambridge, UK)

### E. Male Adapter / Hose Fitting



E

Stainless Steel	Coupling Size	Hose Size	Poly	Poly
-	3/4 inch	1/2 inch	18103E2	02050E12
E-750SS	3/4 inch	3/4 inch	9950-075E	02075E34
E-100SS	1 inch	1 inch	9950-100E	02100E10
-	1-1/4 inch	1-1/4 inch	9950-125E	02125E54
E-150SS	1-1/2 inch	1-1/2 inch	9950-150E	02150E64
E-200SS	2 inch	2 inch	9950-200E	02200E20
E-300SS	3 inch	3 inch	9950-300E	02300E30



E

Available for order through HYPRO-EU only (Cambridge, UK)

### F. Male Adapter / Male Thread



F

Stainless Steel	Coupling Size	Thread Size	Poly	BSP Poly	BSP Poly
-	3/4 inch	1/2 inch	18103F2N	-----	02050F12
F-750SS	3/4 inch	3/4 inch	9950-075NF	9950-075BF	02075F34
F-100SS	1 inch	1 inch	9950-100NF	9950-100BF	02100F10
-	1-1/4 inch	1-1/4 inch	9950-125NF	9950-125BF	02125F54
F-150SS	1-1/2 inch	1-1/2 inch	9950-150NF	9950-150BF	02150F64
F-200SS	2 inch	2 inch	9950-200NF	9950-200BF	02200F20
F-300SS	3 inch	3 inch	9950-300NF	9950-300BF	02300F30



F

Available for order through HYPRO-EU only (Cambridge, UK)

### G. Plug



G

Stainless Steel	Coupling Size	Poly	Poly
DP-750SS	3/4 inch	9950-075G	02075G34
DP-100SS	1 inch	9950-100G	02100G10
-	1-1/4 inch	9950-125G	-
DP-150SS	1-1/2 inch	9950-150G	02150G64
DP-200SS	2 inch	9950-200G	02200G20
DP-300SS	3 inch	9950-300G	02300G30



G

Available for order through HYPRO-EU only (Cambridge, UK)

### H. Cap



H

Stainless Steel	Coupling Size	Poly	Poly
DC-750SS	3/4 inch	9950-075H	02075P34
DC-100SS	1 inch	9950-100H	02100P10
-	1-1/4 inch	9950-125H	-
DC-150SS	1-1/2 inch	9950-150H	02150P64
DC-200SS	2 inch	9950-200H	02200P20
DC-300SS	3 inch	9950-300H	02300P30



H

Available for order through HYPRO-EU only (Cambridge, UK)

### Cam Lock Replacement Gasket



Size	EPDM Part Number	EPDM Part Number	Viton® Part Number
3/4 inch	18103B-050	02--050G	18123B-050
1 inch	18104B-050	02--100G	18124B-050
1-1/4 inch	18105B-050	-	18125B-050
1-1/2 inch	18106B-050	02--150G	18126B-050
2 inch	18107B-050	02--200G	18127B-050
3 inch	18109B-050	02--300G	18129B-050

Available for order through HYPRO-EU only (Cambridge, UK)

# Nylon® and Polypropylene Fittings

## Supplemental Technical Information on Nylon and Polypropylene Fittings



### NYLON FITTINGS

#### Working Pressure:

up to 150 psi (10 bar) at ambient temperatures.

At very low pressures, temperatures can approach 175°F (80° C) with no degradation in the performance of the nylon fitting.

#### Recommended:

- For physical or structural strength
- For broad temperature range
- With PTFE tape

#### Not Recommended:

- Acid-based fertilizers/defoliants
- Prolonged sunlight/UV exposure

### POLYPROPYLENE FITTINGS

#### Working Pressure:

up to 150 psi (10 bar) at ambient temperatures

As with all thermoplastics, an increase in working temperature is accompanied by a decrease in acceptable operating pressure. At 140°F (60°C), the working pressure limit is 90 psi (6 bar).

#### Recommended:

- Hand tight, plus 1 turn
- For normal ag growing season conditions
- For acid resistance
- For Sunlight/UV resistance
- For cosmetic appearance

#### Not Recommended:

- Impact wrench, other over tightening
- For temperature extremes
- With PTFE tape
- For toluene or xylene-based compounds

### Chemical Resistance

Chemical	Nylon	Polypropylene
<b>Most Agricultural Chemicals</b>	Green	Green
<b>Acidic Fertilizers</b>	Red	Green
<b>Ammonium Compounds</b>	Green	Green
<b>Aromatic Hydrocarbons</b>	Red	Red
<b>Bromine</b>	Red	Red
<b>Calcium Carbonate</b>	Green	Green
<b>Carbon Tetrachloride</b>	Yellow	Red
<b>Chlorine</b>	Red	Yellow
<b>Detergents</b>	Green	Green
<b>Diesel Fuel</b>	Green	Red
<b>Ethanol</b>	Green	Green
<b>Fluorine</b>	Red	Red
<b>Gasoline</b>	Green	Red
<b>Hexane</b>	Green	Red
<b>Hydrochloric Acid</b>	Red	Green
<b>Iodine</b>	Red	Yellow
<b>Kerosene</b>	Green	Red

Chemical	Nylon	Polypropylene
<b>Magnesium Sulfate</b>	Green	Green
<b>Nitric Acid</b>	Red	Yellow
<b>Oxalic Acid</b>	Red	Green
<b>Phosphoric Acid</b>	Red	Green
<b>Propionic Acid</b>	Green	Green
<b>Most Sodium Compounds</b>	Green	Green
<b>Sodium Hypochlorite</b>	Red	Yellow
<b>Sulfuric Acid</b>	Red	Yellow
<b>Toluene</b>	Green	Red
<b>Trichloroethylene</b>	Green	Red
<b>Xylene</b>	Green	Red
<b>Zinc Sulfate</b>	Green	Green

Key	
<b>Chemical Resistance:</b>	Green
<b>Consult Factory:</b>	Yellow
<b>Not Recommended:</b>	Red

Nylon® is a registered trademark of Dupont Co. Hypro® is a registered trademark of Pentair.

# Fittings - Plastic

## Male MNPT Pipe Thread By Hose Barb

Std Pack	MPT X HB	Nylon	Poly
25	1/8 inch X 3/16 inch (4,7 mm)	A18316	3A18316
25	1/8 inch X 1/4 inch (6,4 mm)	A1814	3A1814
25	1/8 inch X 5/16 inch (8 mm)	A18516	-
25	1/8 inch X 3/8 inch (10 mm)	A1838	3A1838
25	1/4 inch X 3/16 inch (4,7 mm)	A14316	-
25	1/4 inch X 1/4 inch (6,4 mm)	A14	3A14
25	1/4 inch X 5/16 inch (8 mm)	A14516	-
25	1/4 inch X 3/8 inch (10 mm)	A1438	3A1438
25	1/4 inch X 1/2 inch (13 mm)	A1412	3A1412
25	3/8 inch X 1/4 inch (6,4 mm)	A3814	3A3814
25	3/8 inch X 5/16 inch (8 mm)	A38516	3A38516
25	3/8 inch X 3/8 inch (10 mm)	A38	3A38
25	3/8 inch X 1/2 inch (13 mm)	A3812	3A3812
25	3/8 inch X 5/8 inch (16 mm)	A3858	3A3858
25	1/2 inch X 3/16 inch (4,7 mm)	A12316	-
25	1/2 inch X 1/4 inch (6,4 mm)	A1214	3A1214
25	1/2 inch X 3/8 inch (10 mm)	A1238	3A1238
25	1/2 inch X 1/2 inch (13 mm)	A12	3A12
25	1/2 inch X 5/8 inch (16 mm)	A1258	3A1258
25	1/2 inch X 3/4 inch (19 mm)	A1234	3A1234
25	1/2 inch X 1 inch (25 mm)	A12100	-
25	3/4 inch X 1/4 inch (6,4 mm)	A3414	3A3414
25	3/4 inch X 3/8 inch (10 mm)	A3438	3A3438
25	3/4 inch X 1/2 inch (13 mm)	A3412	3A3412
25	3/4 inch X 5/8 inch (16 mm)	A3458	3A3458
25	3/4 inch X 3/4 inch (19 mm)	A34	3A34
25	3/4 inch X 1 inch (25 mm)	A34100	3A34100
25	1 inch X 3/4 inch (19 mm)	A10034	3A10034
25	1 inch X 1 inch (25 mm)	A100	3A100
25	1 inch X 1 1/4 inch (32 mm)	A100114	3A100114
1	1-1/4 inch X 3/4 inch (19 mm)	A11434	3A11434
1	1-1/4 inch X 1 inch (25 mm)	A114100	3A114100
1	1-1/4 inch X 1-1/4 inch (32 mm)	A114	3A114
1	1-1/4 inch X 1-1/2 inch (38 mm)	A114112	3A114112
1	1-1/2 inch X 1-1/4 inch (32 mm)	A112114	3A112114
1	1-1/2 inch X 1-1/2 inch (38 mm)	A112	3A112
1	2 inch X 2 inch (50 mm)	A200	3A200
1	3 inch X 3 inch (76mm)	--	3A300



## Elbows: Male Pipe Thread By Hose Barb

Std Pack	MPT X HB	Nylon	Poly
25	1/8 inch X 3/16 inch (4,7 mm)	EL18316	-
25	1/8 inch X 1/4 inch (6,4 mm)	EL1814	3EL1814
25	1/8 inch X 5/16 inch (8 mm)	EL18516	-
25	1/8 inch X 3/8 inch (10 mm)	EL1838	3EL1838
25	1/4 inch X 3/16 inch (4,7 mm)	-	3EL14316
25	1/4 inch X 1/4 inch (6,4 mm)	EL14	3EL14
25	1/4 inch X 5/16 inch (8 mm)	EL14516	-
25	1/4 inch X 3/8 inch (10 mm)	EL1438	3EL1438
25	1/4 inch X 1/2 inch (13 mm)	EL1412	3EL1412
25	1/4 inch X 5/8 inch (16 mm)	EL1458	-
25	3/8 inch X 1/4 inch (6,4 mm)	EL3814	3EL3814
25	3/8 inch X 5/16 inch (8 mm)	EL38516	-
25	3/8 inch X 3/8 inch (10 mm)	EL38	3EL38
25	3/8 inch X 1/2 inch (13 mm)	EL3812	3EL3812
25	3/8 inch X 5/8 inch (16 mm)	EL3858	3EL3858
25	1/2 inch X 1/4 inch (6,4 mm)	EL1214	3EL1214
25	1/2 inch X 3/8 inch (10 mm)	EL1238	3EL1238
25	1/2 inch X 1/2 inch (13 mm)	EL12	3EL12
25	1/2 inch X 5/8 inch (16 mm)	EL1258	3EL1258
25	1/2 inch X 3/4 inch (19 mm)	EL1234	3EL1234
25	1/2 inch X 1 inch (25 mm)	EL12100	-
25	3/4 inch X 1/4 inch (6,4 mm)	EL3414	3EL3414
25	3/4 inch X 3/8 inch (10 mm)	EL3438	3EL3438
25	3/4 inch X 1/2 inch (13 mm)	EL3412	3EL3412
25	3/4 inch X 5/8 inch (16 mm)	EL3458	3EL3458
25	3/4 inch X 3/4 inch (19 mm)	EL34	3EL34
25	3/4 inch X 1 inch (25 mm)	EL34100	3EL34100
25	1 inch X 1/2 inch (13 mm)	EL10012	3EL10012
25	1 inch X 3/4 inch (19 mm)	EL10034	3EL10034
25	1 inch X 1 inch (25 mm)	EL100	3EL100
1	1 inch X 1 1/4 inch (32 mm)	--	3EL100114
1	1-1/4 inch X 3/4 inch (19 mm)	EL11434	3EL11434
1	1-1/4 inch X 1 inch (25 mm)	EL114100	3EL114100
1	1-1/4 inch X 1-1/4 inch (32 mm)	EL114	3EL114
1	1-1/4 inch X 1-1/2 inch (38 mm)	EL114112	3EL114112
1	1-1/2 inch X 1-1/4 inch (32 mm)	EL112114	3EL112114
1	1-1/2 inch X 1-1/2 inch (38 mm)	EL112	3EL112
1	2 inch X 2 inch (50 mm)	EL200	3EL200
1	3 inch X 3 inch (76mm)	--	3EL300

Add Prefix "BG" for 1 part per retail bag.

## Elbows: Female Pipe Thread By Hose Barb

Std Pack	FPT X HB	Nylon	Poly
25	1/4 inch X 3/16 inch (4,7 mm)	-	3EL14316F
25	1/4 inch X 1/4 inch (6,4 mm)	EL14F	3EL14F
25	1/4 inch X 3/8 inch (10 mm)	EL1438F	3EL1438F
25	3/8 inch X 1/4 inch (6,4 mm)	EL3814F	3EL3814F
25	3/8 inch X 3/8 inch (10 mm)	EL38F	3EL38F
25	3/8 inch X 1/2 inch (13 mm)	EL3812F	3EL3812F
25	1/2" inch X 1/2 inch (13mm)	--	3EL12F
25	1/2 inch X 5/8 inch (16 mm)	EL1258F	3EL1258F
25	1/2 inch X 3/4 inch (19 mm)	EL1234F	3EL1234F
25	3/4 inch X 1/2 inch (13 mm)	EL3412F	3EL3412F
25	3/4 inch X 5/8 inch (16 mm)	EL3458F	3EL3458F
25	3/4 inch X 3/4 inch (19 mm)	EL34F	3EL34F

## Street Elbows: Female Pipe Thread By Male Pipe Thread

Std Pack	FPT X MPT	Nylon	Poly
25	1/4 inch X 1/4 inch	SE14	3SE14
25	3/8 inch X 3/8 inch	SE38	3SE38
25	1/2 inch X 1/2 inch	SE12	3SE12
25	3/4 inch X 3/4 inch	SE34	3SE34
10	1 inch X 1 inch	SE100	3SE100
1	1 1/4 inch X 1 1/4 inch	SE114	3SE114
1	1 1/2 inch X 1 1/2 inch	SE112	3SE112
1	2 inch X 2 inch	SE200	3SE200

Add Prefix "BG" for 1 part per retail bag.

Add Prefix "5BG" for 5 parts per retail bag.

Add Prefix "BG" for 1 part per retail bag.

## Female Pipe Thread By Hose Barb

Std Pack	FPT X HB	Nylon	Poly
25	1/4 inch X 1/4 inch (6,4 mm)	AF14	3AF14
25	1/4 inch X 3/8 inch (10 mm)	AF1438	3AF1438
25	3/8 inch X 1/4 inch (6,4 mm)	AF3814	3AF3814
25	3/8 inch X 3/8 inch (10 mm)	AF38	3AF38
25	3/8 inch X 1/2 inch (13 mm)	AF3812	3AF3812
25	1/2 inch X 1/4 inch (6,4 mm)	AF1214	3AF1214
25	1/2 inch X 3/8 inch (10 mm)	AF1238	3AF1238
25	1/2 inch X 1/2 inch (13 mm)	AF12	3AF12
25	1/2 inch X 5/8 inch (16 mm)	AF1258	3AF1258
25	1/2 inch X 3/4 inch (19 mm)	AF1234	3AF1234
25	3/4 inch X 3/8 inch (10 mm)	AF3438	3AF3438
25	3/4 inch X 1/2 inch (13 mm)	AF3412	3AF3412
25	3/4 inch X 5/8 inch (16 mm)	-	3AF3458
25	3/4 inch X 3/4 inch (19 mm)	AF34	3AF34



### Street Elbows – 45°



Std Pack	MPT X FPT	Nylon	Poly
25	3/4 inch X 3/4 inch	SE3445	3SE3445
10	1/4 inch X 1/4 inch	SE1445	-

### Elbows: Female Pipe Thread – 90°



Std Pack	FPT X FPT	Nylon	Poly
25	1/2 inch X 1/2 inch	LL12	3LL12
10	3/4 inch X 3/4 inch	LL34	3LL34
1	1 inch X 1 inch	LL100	3LL100
1	1 1/4 inch X 1 1/4 inch	LL114	3LL114
1	1 1/2 inch X 1 1/2 inch	LL112	3LL112
1	2 inch X 2 inch	LL200	3LL200



### Tees: Female Pipe Thread



Std Pack	FPT X FPT X FPT	Nylon	Poly
25	1/4 inch	TT14	3TT14
10	1/2 inch	TT12	3TT12
10	3/4 inch	TT34	3TT34
1	1 inch	TT100	3TT100
1	1 1/4 inch	TT114	3TT114
1	1 1/2 inch	TT112	3TT112
1	2 inch	TT200	3TT200



### Tees: Female Pipe Thread with 1/4 inch Gauge Port



Std Pack	FPT X FPT X FPT	Nylon	Poly
25	1/2 inch	GTT1214	3GTT1214
1	3/4 inch	GTT3414	3GTT3414

Add Prefix "BG" for 1 part per retail bag.



### Reducer Bushings



Std Pack	MPT X FPT	Nylon	Poly
25	1/4 inch X 1/8 inch	-	3RB1418
25	3/8 inch X 1/8 inch	RB3818	3RB3818
25	3/8 inch X 1/4 inch	RB3814	3RB3814
25	1/2 inch X 1/8 inch	RB1218	3RB1218
25	1/2 inch X 1/4 inch	RB1214	3RB1214
25	1/2 inch X 3/8 inch	RB1238	3RB1238
25	3/4 inch X 1/8 inch	RB3418	3RB3418
25	3/4 inch X 1/4 inch	RB3414	3RB3414
25	3/4 inch X 3/8 inch	RB3438	3RB3438
25	3/4 inch X 1/2 inch	RB3412	3RB3412
25	1 inch X 1/2 inch	RB10012	3RB10012
25	1 inch X 3/4 inch	RB10034	3RB10034
1	1-1/4 inch X 3/4 inch	RB11434	3RB11434
1	1-1/4 inch X 1 inch	RB114100	3RB114100
1	1-1/2 inch X 3/4 inch	RB11234	3RB11234
1	1-1/2 inch X 1 inch	RB112100	3RB112100
1	1-1/2 inch X 1-1/4 inch	RB112114	3RB112114
1	2 inch X 3/4 inch	RB20034	3RB20034
1	2 inch X 1 inch	RB200100	3RB200100
1	2 inch X 1-1/4 inch	RB200114	3RB200114
1	2 inch X 1-1/2 inch	RB200112	3RB200112
1	2-1/2 inch X 2 inch	RB212200	-
1	3 inch X 2 inch	RB300200	3RB300200

Add Prefix "BG" for 1 part per retail bag.  
Add Prefix "5BG" for 5 parts per retail bag.



### Nipples: Male Pipe Thread By Male Pipe Thread

Std Pack	MPT X MPT	Nylon	Poly
25	1/8" X 1/8"	M18	3M18
25	1/4" X 1/4"	M14	3M14
25	3/8" X 3/8"	M38	3M38
25	1/2" X 1/2"	M12	3M12
25	3/4" X 3/4"	M34	3M34
25	1" X 1"	M100	3M100
1	1-1/4" X 1-1/4"	M114	3M114
1	1-1/2" X 1-1/2"	M112	3M112
1	2" X 2"	M200	3M200
25	1/4" X 1/8"	M1418	3M1418
25	3/8" X 1/8"	M3818	3M3818
25	3/8" X 1/4"	M3814	3M3814
25	1/2" X 1/8"	M1218	-
25	1/2" X 1/4"	M1214	3M1214
25	1/2" X 3/8"	M1238	3M1238
25	3/4" X 3/8"	M3438	3M3438
25	3/4" X 1/2"	M3412	3M3412
1	1" X 3/4"	--	3M10034

### Female Coupler

Std Pack	FPT X FPT	Nylon	Poly
25	1/2" X 1/2"	FC12	3FC12
25	3/4" X 3/4"	FC34	3FC34
25	1" X 1"	FC100	3FC100
1	1-1/4" X 1-1/4"	FC114	3FC114
1	1-1/2" X 1-1/2"	FC112	3FC112
1	2" X 2"	FC200	3FC200

### Hex Plug with Male Pipe Thread

Std Pack	MPT	Nylon	Poly
25	1/8"	F18	3F18
25	1/4"	F14	3F14
25	3/8"	F38	3F38
25	1/2"	F12	3F12
25	3/4"	F34	3F34
25	1"	F100	3F100
1	1-1/4"	F114	3F114
1	1-1/2"	F112	3F112
1	2"	F200	3F200

### Hose Barb Fittings

Std Pack	HB X HB		Nylon	Poly
	US Units	Metric Units		
25	1/4" X 1/4"	6,4 x 6,4 mm	EL14HB	3EL14HB
25	3/8" X 1/4"	10 x 6,4 mm	EL3814HB	3EL3814HB
25	3/8" X 3/8"	10 x 10 mm	EL38HB	3EL38HB
25	1/2" X 1/4"	13 x 6,4 mm	EL1214HB	3EL1214HB
25	1/2" X 3/4"	10 x 19 mm	EL1238HB	3EL1238HB
25	1/2" X 1/2"	10 x 10 mm	EL12HB	3EL12HB
25	5/8" X 5/8"	16 x 16 mm	EL58HB	3EL58HB
25	3/4" X 5/8"	19 x 16 mm	EL3458HB	3EL3458HB
25	3/4" X 3/4"	19 x 19 mm	EL34HB	3EL34HB
25	1" X 1"	25 x 25 mm	EL100HB	-
1	1-1/4" X 1-1/4"	32 x 32 mm	EL114HB	3EL114HB
1	1-1/2" X 1-1/2"	38 x 38 mm	EL112HB	3EL112HB
1	2" X 2"	50 x 50 mm	EL200HB	3EL200HB

### Hose Mender



Std Pack	HB X HB		Nylon	Poly
	US Units	Metric Units		
25	1/8" x 1/8"	3,2 x 3,2 mm	HM18*	-
25	1/4" x 3/16"	6,4 x 4,7 mm	HM14316*	-
25	1/4" x 1/4"	6,4 x 6,4 mm	SHM14	3SHM14
25	1/4" x 1/4"	6,4 x 6,4 mm	HM14*	3HM14*
25	5/16" x 5/16"	8 x 8 mm	HM516*	3HM516*
25	3/8" x 1/4"	10 x 6,4 mm	HM3814*	3HM3814*
25	3/8" x 3/8"	10 x 10 mm	SHM38	3SHM38
25	1/2" x 1/4"	13 x 6,4 mm	HM1214*	3HM1214*
25	1/2" x 3/8"	13 x 10 mm	SHM1238	3SHM1238
25	1/2" x 3/8"	13 x 10 mm	HM1238*	3HM1238*
25	1/2" x 1/2"	13 x 13 mm	SHM12	3SHM12
25	1/2" x 5/8"	13 x 16 mm	SHM1258	3SHM1258
25	5/8" x 3/8"	16 x 10 mm	HM5838*	3HM5838*
25	5/8" x 5/8"	16 x 16 mm	SHM58	3SHM58
25	5/8" x 5/8"	16 x 16 mm	HM58*	-
25	3/4" x 3/4"	19 x 19 mm	SHM34	3SHM34
25	1" x 1"	25 x 25 mm	SHM100	3SHM100
1	1-1/4" x 1-1/4"	32 x 32 mm	SHM114	3SHM114
1	1-1/2" x 1-1/2"	38 x 38 mm	SHM112	3SHM112
1	2" x 2"	50 x 50 mm	SHM200	3SHM200

\*No centre stop as pictured.



### Tees: Hose Barb By Female Pipe Thread

Std Pack	FPT X HB (1 X 2 & 3)	Nylon	Poly
25	3/4" X 3/4" (19 mm)	T34F	3T34F

### Male Garden Hose Thread By Hose Barb

Std Pack	MGHT X HB	Nylon	Poly
25	3/4" X 1/4" (6.4 mm)	D3414	-
25	3/4" X 3/8" (10 mm)	D3438	3D3438
25	3/4" X 1/2" (13 mm)	D3412	3D3412
25	3/4" X 5/8" (16 mm)	D3458	3D3458
25	3/4" X 3/4" (19 mm)	D34	3D34
25	3/4" X 1" (25 mm)	D34100	-

Add Prefix "BG-" for 1 part per retail bag



### Elbows: Male Garden Hose Thread By Hose Barb

Std Pack	MGHT X HB	Nylon	Poly
25	3/4" X 1/4" (6.4 mm)	ELD3414	3ELD3414
25	3/4" X 3/8" (10 mm)	ELD3438	3ELD3438
25	3/4" X 1/2" (13 mm)	ELD3412	3ELD3412
25	3/4" X 5/8" (16 mm)	ELD3458	-
25	3/4" X 3/4" (19 mm)	ELD34	3ELD34



### Tees: Hose Barbs



Std Pack	HB X HB (1 X 2,3)		Nylon	Poly
	US Units	Metric Units		
25	1/8" X 1/8"	3,2 x 3,2 mm	T18	-
25	1/4" X 1/4"	6,4 x 6,4 mm	T14	3T14
25	1/4" X 3/8"	6,4 x 10 mm	T1438	3T1438
25	3/8" X 3/8"	10 x 10 mm	T38	3T38
25	3/8" X 1/2"	10 x 13 mm	T3812	3T3812
25	3/8" X 5/8"	10 x 16 mm	T3858	-
25	1/2" X 3/8"	13 x 10 mm	T1238	3T1238
25	1/2" X 1/2"	13 x 13 mm	T12	3T12
25	5/8" X 5/8"	16 x 16 mm	T58	3T58
25	3/4" X 1/2"	19 x 13 mm	T3412	3T3412
25	3/4" X 3/4"	19 x 19 mm	T34	3T34
25	1" X 1"	25 x 25 mm	T100	3T100
1	1-1/4" X 1-1/4"	32 x 32 mm	T114	3T114
1	1-1/2" X 1-1/2"	38 x 38 mm	T112	3T112
1	2" X 2"	50 x 50 mm	T200	3T200

### Adapters: Male Garden Hose Thread By Male Pipe Thread

Std Pack	MGHT X MPT	Nylon	Poly
25	3/4" X 3/8"	E3438	3E3438
25	3/4" X 1/2"	E3412	3E3412
25	3/4" X 3/4"	E34	3E34



### Adapter Couplings: Female Garden Hose Thread By Female Pipe Thread

Std Pack	FGHT X FPT	Nylon	Poly
25	3/4" X 1/2"	J3412	3J3412



### Tees: Male Pipe Thread By Hose Barbs



Std Pack	MPT X HB (1 X 2,3)	Nylon	Poly
25	1/8" X 1/4" (6.4 mm)	T1814T	-
25	1/4" X 1/4" (6.4 mm)	T14T	3T14T
25	1/4" X 3/8" (16 mm)	T1438T	3T1438T
25	1/4" X 1/2" (13 mm)	T1412T	-
25	3/8" X 1/4" (6.4 mm)	T3814T	-
25	3/8" X 3/8" (10 mm)	T38T	3T38T
25	3/8" X 1/2" (13 mm)	T3812T	3T3812T
25	1/2" X 3/8" (10 mm)	T1238T	3T1238T
25	1/2" X 1/2" (13 mm)	T12T	3T12T
25	1/2" X 5/8" (16 mm)	T1258T	-
25	1/2" X 3/8" (19 mm)	T1234T	3T1234T
25	3/4" X 3/8" (10 mm)	-	3T3438T
25	3/4" X 1/2" (13 mm)	T3412T	3T3412T
25	3/4" X 5/8" (16 mm)	-	3T3458T
25	3/4" X 3/4" (19 mm)	T34T	3T34T
25	3/4" X 1" (25 mm)	T34100T	-



### Adapters: Female Garden Hose Thread By Male Pipe Thread

Std Pack	FGHT X MPT	Nylon	Poly
25	3/4" X 3/4"	H34	3H34



### Adapters: Male Garden Hose Thread By Female Pipe Thread

Std Pack	MGHT X FPT	Nylon	Poly
25	3/4" X 1/2"	G3412	3G3412
25	3/4" X 1/4"	G3414	3G3414
25	3/4" X 3/4"	G34	3G34



### Adapters: Flat Seat by Male Pipe Thread

Std Pack	MPT	Nylon	Poly
25	1/2"	C12NPT	3C12NPT



### Adapters: Female Garden Hose Thread By Male Garden Hose Thread

Std Pack	FGHT X MGHT	Nylon	Poly
25	3/4" X 3/4"	I34	3I34



### Female Garden Hose Cap Knurled

Std Pack	FGHT	Nylon	Poly
25	3/4"	N34	3N34



### Female Pipe Thread By Hose Barb Fitting

Std Pack	FPT X HB	Nylon	Poly
25	1/2" X 1/2" (13 mm)	Q12	3Q12
50	1/4" X 1/4" (6,4 mm)	Q14	3Q14



### Female Pipe Straight Swivel Nut-Hex

Std Pack	FPS	Nylon	Poly
25	1"	B100	3B100



### Female Garden Hose and Female Pipe Straight Swivel Nut-Knurled

Std Pack	FGHT	FPS	Nylon	Poly
25	3/4"	-	B34	3B34
25	-	3/4"	B35	3B35



### Flat Seat Hose Barb

Std Pack	HB		Nylon	Poly
	US Units	Metric Units		
25	1/4"	6.4 mm	C14	3C14
25	3/8"	10 mm	C38	3C38
25	1/2"	13 mm	C12	3C12
25	5/8"	16 mm	C58	3C58
25	3/4"	19 mm	C34	3C34
25	1"	25 mm	C100	3C100



### Female Thread Swivel Hex Nut, Barb Insert with Ball Seat

Std Pack	Size		Nylon
	US Units	Metric Units	
<b>BARB ONLY</b>			
50	1/4" HB	6.4 mm	NC14
50	3/8" HB	10 mm	NC38
50	1/2" HB	13 mm	NC12
<b>NUT ONLY</b>			
50	1/4"	13 mm	NC14N
50	3/8"	10 mm	NC38N
50	1/2"	13 mm	NC12N
50	1/2" with 1/4" HB	13 mm with 6.4 mm HB	NC1214



### Washers

Reference #	Std Pack	OD X ID	Description	Part Number
1	100	1" X 3/4"	Black Vinyl	t
2	100	1" X 5/8"	S.S. Filter 50/60 Mesh	W160M
3	100	1" X 1/2"	Natural Polypropylene	W405P



### Rope Wick Parts Unassembled

Std Pack	Description	Nylon	Poly
25	3/4" MGHT X 3/4" MPT (A)	E34	3E34
25	3/4" FGHT Nut with 1/2" hole (B)	B3412	3B3412
25	3/4" MGHT X 1/2" MPT (C)	E3412	3E3412



### Rope Wick Parts Unassembled

Ref. Letter	Std Pack	Description	Nylon	Poly
A	100	Nylon Washer	RW1116A	3RW1116A
B	50	Main Body	RW1116B	-
C	100	O-ring Black EPDM	RW1116C	RW1116C
D	100	Grommet Black EPDM	RW1116D	RW1116D
E	25	1-1/16" - 16 UN (Lock) Nut	B12	3B12
F	25	1-1/16" - 16 UN Swivel Nut	8027	38027



### Hose-Saver Straight Assembly - Nylon

MPT X HB	Part Number	Cap Part Number
3/4" X 3/4" (19 mm)	626320N	626012
3/4" X 1" (25 mm)	626325N	626014
1" X 1" (25 mm)	626425N	626014
1-1/4" X 1" (25 mm)	626525N	626014
1-1/4" X 1-1/4" (32 mm)	626532N	626014
1-1/2" X 1-1/4" (32 mm)	626632N	626014
1-1/2" X 1-1/2" (38 mm)	626638N	-
1-1/2" X 2" (50 mm)	626651N	-
2" X 2" (50 mm)	626751N	-



### Hose-Saver Elbow Assembly - Nylon

MPT X HB	Part Number	Cap Part Number
3/4" X 3/4" (19 mm)	627320N	626012
3/4" X 1" (19 mm)	627325N	626014
1" X 3/4" (19 mm)	627420N	626012
1" X 1" (19 mm)	627425N	626014
1" X 1-1/4" (19 mm)	627432N	626014
1-1/4" X 1" (19 mm)	627525N	626014
1-1/4" X 1-1/4" (19 mm)	627532N	626014
1-1/2" X 1-1/4" (19 mm)	627632N	626014
1-1/2" X 1-1/2" (19 mm)	627638N	-
2" X 2" (19 mm)	627751N	-

**Male Pipe Thread By Hose Barb**



MPT x HB	316 Stainless Steel
1/4" X 1/4" (6.4 mm)	9A14
1/4" X 3/8" (10 mm)	9A1438
1/4" X 1/2" (13 mm)	9A1412
3/8" X 3/8" (10 mm)	9A38
3/8" X 1/2" (13 mm)	9A3812
1/2" X 1/2" (13 mm)	9A12
3/4" X 3/4" (19 mm)	9A34
1" X 1" (25 mm)	9A100
1-1/4" X 1-1/4" (32 mm)	9A114
1-1/2" X 1-1/2" (38 mm)	9A112
2" X 2" (50 mm)	9A200
3" X 3" (75 mm)	9A300



**Street Elbow:**

**Female Pipe Thread By Male Pipe Thread**

MPT X FPT	304 Stainless Steel
1/4" X 1/4"	7SE14
3/8" X 3/8"	7SE38
1/2" X 1/2"	7SE12
3/4" X 3/4"	7SE34
1" X 1"	7SE100
1-1/2" X 1-1/2"	7SE112
1-1/4" X 1-1/4"	7SE114
2" X 2"	7SE200
3" X 3"	7SE300

**Coupling: Female Pipe Thread**



FPT X FPT	304 Stainless Steel
1/4" X 1/4"	7FC14
1/2" X 1/2"	7FC12
3/4" X 3/4"	7FC34
1" X 1"	7FC100
1-1/2" X 1-1/2"	7FC112
2" X 2"	7FC200
3" X 3"	7FC300



**Tee: Female Pipe Thread**

FPT X FPT X FPT	304 Stainless Steel
1/4"	7TT14
1/2"	7TT12
3/4"	7TT34
1"	7TT100
1-1/4"	7TT114
1-1/2"	7TT112
2"	7TT200
3"	7TT300

**Elbow: Female Pipe Thread - 90°**



FPT X FPT	304 Stainless Steel
1/4" X 1/4"	7LL14
1/2" X 1/2"	7LL12
3/4" X 3/4"	7LL34
1" X 1"	7LL100
1-1/2" X 1-1/2"	7LL112
1-1/4" X 1-1/4"	7LL114
2" X 2"	7LL200
3" X 3"	7LL300



**Nipple**

MPT X Length	304 Stainless Steel
1/4" X 1-1/2"	714112
1/4" X 3"	714300
1/4" X 4"	714400
1/4" X 6"	714600
1/4" X 12"	7141200
3/8" X 1"	738100
3/8" X 1-1/2"	738112
1/2" X 1-1/8"	712118
1/2" X 1-1/2"	712112
1/2" X 2"	712200
3/4" X 1-3/8"	734138
3/4" X 4"	734400
1" X 1-1/2"	7100112
1" X 4"	7100400
1-1/4" X 1-5/8"	7114158
1-1/2" X 1-3/4"	7112134
2" X 2"	7200200
2" X 2-1/2"	7200212
2" X 4"	7200400
2" X 6"	7200600
2" X 3"	7200300
2" X 3-1/2"	7200312
2" X 5"	7200500

**Reducer Bushing**



MPT X FPT	304 Stainless Steel
1/4" X 3/8"	7RB1418
3/8" X 1/4"	7RB3814
1/2" X 1/4"	7RB1214
1/2" X 3/8"	7RB1238
3/4" X 1/4"	7RB3414
3/4" X 1/2"	7RB3412
1" X 1/2"	7RB10012
1" X 3/4"	7RB10034
2" X 1-1/2"	7RB200112



**Hex Plugs**

Part Number	Size
7F18	1/8"
7F14	1/4"
7F38	3/8"
7F12	1/2"
7F34	3/4"
7F100	1"
7F200	2"

# Fittings - Steel



## Male Pipe Thread By Hose Barb

MPT X HB	Steel
1/8" X 1/4" [6.4 mm]	A1814S
1/8" X 3/8" [10 mm]	A1838S
1/4" X 1/4" [6.4 mm]	A14S
1/4" X 3/8" [10 mm]	A1438S
1/4" X 1/2" [13 mm]	A1412S
3/8" X 1/4" [6.4 mm]	A3814S
3/8" X 3/8" [10 mm]	A38S
3/8" X 1/2" [13 mm]	A3812S
1/2" X 1/4" [6.4 mm]	A1214S
1/2" X 3/8" [10 mm]	A1238S
1/2" X 1/2" [13 mm]	A12S
1/2" X 5/8" [16 mm]	A1258S
1/2" X 3/4" [19 mm]	A1234S
3/4" X 3/8" [10 mm]	A3438S
3/4" X 1/2" [13 mm]	A3412S
3/4" X 5/8" [16 mm]	A3458S
3/4" X 3/4" [19 mm]	A34S
3/4" X 1" [25 mm]	A34100S
1" X 1" [25 mm]	A100S

Add Prefix "BG-" for 1 part per retail bag.

## King Nipple



MPT X HB	Plated Steel
3/4" [19 mm]	AA34P
1" X 3/4" [19 mm]	AA10034P
1" [25 mm]	AA100P
1-1/4" [32 mm]	AA114P
1-1/2" [38 mm]	AA112P
2" [50 mm]	AA200P

Add Prefix "BG-" for 1 part per retail bag.



## Female Pipe Straight Swivel Nut - Hex

FPS	Steel
3/4"	B35S

NOTE: For use with steel flat hose barbs 1/4" to 3/4".



## Flat Seat Hose Barb

HB	Steel
1/2" [12 mm]	C12S
3/4" [19 mm]	C34S



## Male Pipe Thread By Hose Barb

MPT X HB	Brass
1/8" X 1/4" [6.4 mm]	A1814B
1/8" X 3/8" [10 mm]	A1838B
1/4" X 1/4" [6.4 mm]	A14B
1/4" X 3/8" [10 mm]	A1438B
1/4" X 1/2" [13 mm]	A1412B
3/8" X 1/4" [6.4 mm]	A3814B
3/8" X 3/8" [10 mm]	A38B
3/8" X 1/2" [13 mm]	A3812B
1/2" X 1/4" [6.4 mm]	A1214B
1/2" X 3/8" [10 mm]	A1238B
1/2" X 1/2" [13 mm]	A12B
1/2" X 5/8" [16 mm]	A1258B
1/2" X 3/4" [19 mm]	A1234B
3/4" X 3/8" [10 mm]	A3438B
3/4" X 1/2" [13 mm]	A3412B
3/4" X 5/8" [16 mm]	A3458B
3/4" X 3/4" [19 mm]	A34B
3/4" X 1" [25 mm]	A34100B
1" X 1" [25 mm]	A100B

## Female Pipe Thread By Hose Barb



FPT X HB	Brass
1/4" X 3/8" [10 mm]	AF1438B

## Street Elbows:

### Female Pipe Thread By Male Pipe Thread



MPT X FPT	Brass
1/4" X 1/4"	SE14B
3/8" X 3/8"	SE38B
1/2" X 1/2"	SE12B

## Hose Mender



HB	Brass
1/4" [6.4 mm] X 1/4" [6.4 mm]	SHM14B
3/8" [10 mm] X 3/8" [10 mm]	SHM38B
1/2" [12 mm] X 1/2" [12 mm]	SHM12B
5/8" [16 mm] X 5/8" [16 mm]	SHM58B
3/4" [19 mm] X 3/4" [19 mm]	SHM34B





**Flat Seat Hose Barb**

HB	Brass
3/8" (10 mm)	C38B
1/2" (13 mm)	C12B
5/8" (16 mm)	C58B
3/4" (19 mm)	C34B



**Swivel Nut  
Hex Female Garden Hose Thread**

FGHT	Brass
3/4"	B33B

**Couplings:**

**Female Pipe Thread**



FPT X FPT	Brass
1/4" X 1/4"	FC14B
1/2" X 1/2"	FC12B

**Male Garden Hose Thread By Hose Barb**



MGHT X HB	Brass
3/4" X 3/8" (10 mm)	D3438B
3/4" X 1/2" (13 mm)	D3412B
3/4" X 5/8" (16 mm)	D3458B
3/4" X 3/4" (19 mm)	D34B



**Swivel Adapter**

MPT	Brass
3/8"	SA38B
1/2"	SA12B



**Adapters:**

**Male Garden Hose Thread By Male Pipe Thread**

MGHT X MPT	Brass
3/4" X 1/2"	E3412B
3/4" X 3/4"	E34B

**Elbows:**

**Female Pipe Thread – 90°**



FPT X FPT	Brass
1/4" X 1/4"	LL14B
1/8" X 1/8"	LL18B



**Hex Plug with Male Pipe Thread**

MPT	Brass
1/4"	F14B
3/8"	F38B
1/2"	F12B



**Reducer Bushings**

MPT X FPT	Brass
1/4" X 1/8"	RB1418B
1/2" X 1/4"	RB1214B
1/2" X 3/8"	RB1238B
3/4" X 1/2"	RB3412B



**Female Garden Hose Swivel Nut – Knurled**

FGHT	Brass
3/4"	B34B

NOTE: For use with flat seat hose barbs 1/4" to 3/4".

# Cable Ties and Clamps



## Cable Ties

Standard Pack	Length		Part Number White Nylon	Part Number Black UV Nylon
	US Units	Metric Units		
100	4 inch	102 mm	NS4	3NS4
100	6-1/8 inch	156 mm	NS7	3NS7
100	7-1/2 inch	170 mm	NS8	3NS8
100	11-1/2 inch	292 mm	NS12	3NS12
100	17-3/4 inch	450 mm	NS17	3NS17
100	21-3/4 inch	552 mm	NS21	3NS21
100	28-3/8 inch	720 mm	NS28	3NS28
100	37-1/4 inch	946 mm	NS32	3NS32



NOTE: 10 per box - order in box multiples

## Hose Clamps

Part Number	Fits Hose Min		Fits Hose Max		Normal Hose Size*	
	<b>5/16 inch BAND</b>					
4JM	7/32 inch	5,6 mm	5/8 inch	16 mm	1/4 inch	6,4 mm
6JM	5/16 inch	8 mm	7/8 inch	22 mm	3/8 inch	10 mm
8JM	7/16 inch	11 mm	1 inch	25 mm	1/2 inch	13 mm
10JM	1/2 inch	13 mm	1 1/16 inch	27 mm	5/8 inch	16 mm
12JM	9/16 inch	14 mm	1 1/4 inch	32 mm	3/4 inch	19 mm
16JM	1 1/16 inch	18 mm	1 1/2 inch	38 mm	1 inch	25 mm
<b>1/2 inch BAND</b>						
6J	3/8 inch	10 mm	7/8 inch	22 mm	3/8 inch	10 mm
8J	7/16 inch	11 mm	1 inch	25 mm	1/2 inch	13 mm
10J	9/16 inch	14 mm	1-1/16 inch	27 mm	5/8 inch	16 mm
12J	9/16 inch	14 mm	1-1/4 inch	32 mm	3/4 inch	19 mm
16J	1 1/16 inch	18 mm	1-1/2 inch	38 mm	1 inch	25 mm
20J	3/4 inch	19 mm	1-3/4 inch	44 mm	1-1/4 inch	32 mm
24J	1-1/16 inch	27 mm	2 inch	50 mm	1-1/2 inch	38 mm
28J	1-5/16 inch	33 mm	2-1/4 inch	57 mm	1-3/4 inch	44 mm
32J	1-9/16 inch	40 mm	2-1/2 inch	64 mm	2 inch	50 mm
36J	1-13/16 inch	46 mm	2-3/4 inch	70 mm	2-1/4 inch	57 mm
40J	2-1/16 inch	52 mm	3 inch	76 mm	2-1/2 inch	64 mm
44J	2-5/16 inch	59 mm	3-1/4 inch	83 mm	2-3/4 inch	70 mm
48J	2-9/16 inch	65 mm	3-1/2 inch	89 mm	3 inch	76 mm
52J	2-13/16 inch	71 mm	3-3/4 inch	95 mm	3-1/4 inch	83 mm
56J	3-1/16 inch	78 mm	4 inch	102 mm	3-1/2 inch	89 mm
64J	3-1/2 inch	89 mm	4-1/2 inch	114 mm	4 inch	102 mm
104J	5 inch	127 mm	7 inch	178 mm	6-1/2 inch	165 mm

\* Hose sizes are based on inside I.D.

# Sealant



## Rector Seal

Part Number	Type	Container	
		US Units	Metric Units
28651	21 Black Jack	1/2 Pint Can	.24 Litre
28541	21 Black Jack	1 Pint Can	.47 Litre



## Liquid Teflon Sealant

Part Number	Size		Container
	US Units	Metric Units	
LT2	2 oz.	59 mL	Tube
LT4	4 oz.	118 mL	Can
LT8	8 oz.	237 mL	Can



## Teflon Tape

Part Number	Size		Container
	US Units	Metric Units	
1252	1/2"	13 mm	520"

# Index

Part Number	Page	Part Number	Page	Part Number	Page	Part Number	Page
002201-3470	240	02300G30	255	1510-0075	86	1552C-130E	46
002201-3460	240	02300P30	255	1520-0034	54	1552C-130ESP	47
002201-3440	240	02--050G	255	1520-1075	228	1552C-130SP	47
002201-3430	240	02--100G	255	1520-1100	228	1572-SPX	62
003430	240	02--150G	255	1520-1125	228	1573-SPX	62
003440	240	02--200G	255	1520-1150	228	15-14	248
003460	240	02--300G	255	1520-1075SS	228	15Q2530TC	202
003470	240	104J	264	1520-1100SS	228	166-200-36	97
0113434307	227	10AEE930003	198	1520-1125SS	228	166-200-46	97
0113434308	227	10BG-1700-0255	170, 201	1520-1150SS	228	166-200-56	97
01134343010	227	10BG-30-DC-00	170	1521C-65	46	166-200-57	97
0135606H	231	10BG-30-DC-01	170, 173	1521C-65M	46	16842490	201
01WSHR13	124	10BG-30-DC010	170	1522C-65SP	47	16842491	201
02050D12	255	10BG-30-DC-015	170, 173	152607TC	202	16JM	264
02050E12	255	10BG-30-DC018	170	1530-0024S	53	16J	264
02050F12	255	10BG-30-DC-02	170, 173	1530-0028S	53	16Q2530TC	202
02075A34	254	10BG-30-DC023	170	1532C-160HSP	59	1700-0044	237
02075B34	254	10BG-30-DC-03	170, 173	1532C-6SP	59	1700-0045	237
02075C34	254	10BG-30-DC-035	170	1533C-13ESP	59	1700-0057	237
02075D34	255	10BG-30-DC-04	170, 173	1533C-13SP	59	1700-0058	237
02075E34	255	10BG-30-DC-05	170, 173	1533C-390EHSP	59	1700-0064	237
02075F34	255	10BG-30-DC-06	170, 173	1534	83	1700-0065	237
02075G34	255	10BG-30-DC-07	170, 173	1535	84	1700-0090	236
02075P34	255	10BG-30-DC-08	170, 173	1536-SP	49	1700-0091	236
02100A10	254	10BG-30-DC-10	170, 173	1536	48	1700-0092	236
02100B10	254	10BG-30-DC-12	170, 173	1537-SP	49	1700-0255	135
02100C10	254	10JM	264	1537	48	1700C	69
02100D10	255	10J	264	1538-SP	47, 49	1700N	69
02100E10	255	1212S18	198	1538	46, 48	1700XL	69
02100F10	255	1252	264	1539-SP	49	171N-100	249
02100G10	255	12JM	264	1539	48	171N-12	249
02100P10	255	12J	264	1540-SP	49	171N-14	249
02125A54	254	1320-0015	71, 72	1540	48	171N-112	249
02125B54	254	1320-0016	71, 72	1541A-SP	61	171N-114	249
02125C54	254	1320-0054	72	1542A-160HSP	61	171N-200	249
02125D54	255	1320-0076	71, 72	1542A-550BSP	61	171N-34	249
02125E54	255	1320-0077	71, 72	1542A-65SP	61	171N-38	249
02125F54	255	1320-0078	71, 72	1542P-160HSP	56	1721-0010	124
02150A64	254	1320-0079	71, 72	1542P-200HSP	56	1721-0220	223
02150B64	254	1320-0080	71, 72	1542P-550BSP	56	1723-0142	223
02150C64	254	1320-0081	71, 72	1542P-55SP	56	1802C	115
02150D64	255	1320-0082	72	1542P-65ESP	56	1803C	115
02150E64	255	1320-0083	72	1542P-65SP	56	1804C	115
02150F64	255	1323-0072	71, 72	1542P-65SPM	56	1805C	115
02150G64	255	1323-0073	71, 72	1542P-950BSP	56	1806C	115
02150P64	255	1323-0074	71, 72	1543A-160HSP	61	1807C	115
02200A20	254	1323-0075	71, 72	1543A-160HTSP	61	18103B-050	255
02200B20	254	1323-0076	71, 72	1543A-65SP	61	18103D2N	255
02200C20	254	1323-0077	71, 72	1543A-65TSP	61	18103E2	255
02200D20	255	1323-0078	72	1543P-130ESP	56	18103F2N	255
02200E20	255	1323-0079	72	1543P-130ESP-01	56	18104B-050	255
02200F20	255	141418	198	1543P-130SP	56	18105B-050	255
02200G20	255	1442P-65SP	56	1543P-390EHSP	56	18106B-050	255
02200P20	255	1502C	70	1550-BSP	50	18107B-050	255
02300A30	254	1502N	70	1550-SP	50	18109B-050	255
02300B30	254	1502XL	70	1550	50	18123B-050	255
02300C30	254	1510-0001	86	1551-BSP	47	18124B-050	255
02300D30	255	1510-0002	86	1551-SP	47, 50	18125B-050	255
02300E30	255	1510-0005	86	1551	46, 50	18126B-050	255
02300F30	255	1510-0016	86	1552C-130	46	18127B-050	255

# Index

Part Number	Page	Part Number	Page	Part Number	Page	Part Number	Page
18129B-050	255	2160-0047	86, 119	2410-0038	219	2410-0099	219
1824C	115	2160-0048	86, 119	2410-0039	219	2410-0100	219
1825C	115	2220B-AP	110	2410-0040	219	2410B-P	106
1826C	115	2220B-HP	110	2410-0041	219	2411B-P	106
1827C	115	2220B-P	110	2410-0042	219	2412B-P	106
203282152	236	2221B-AP	110	2410-0043	219	2413B-P	106
203282153	236	2221B-HP	110	2410-0044	219	2414B-P	106
203282162	236	2221B-P	110	2410-0045	219	2430B-P	106
203282163	236	2230B-AP	110	2410-0047	219	2431B-P	106
2032821535	236	2230B-HP	110	2410-0048	219	2432B-P	106
2032821635	236	2230B-P	110	2410-0049	219	2433B-P	106
2087-593-135	95	2231B-AP	110	2410-0050	219	2434B-P	106
2088-313-145	95	2231B-CP	110	2410-0051	219	244-3366	101
2088-343-135	95	2231B-HP	110	2410-0052	219	244-5126	101
2088-343-170	96	2231B-P	110	2410-0053	219	244-6128	101
2088-343-500	96	2270-0136	201	2410-0054	219	24J	264
2088-394-144	96	22W11MF64	141, 143, 145, 151, 153, 155, 157, 167, 189, 201, 202	2410-0055	219	251032BL	197
2088-394-154	96			2410-0056	219	251032GY	197
2088-443-144	95			2410-0057	219	251032WH	197
2088-562-144	96	22W11MF64V	202	2410-0058	219	2510-0001	119
2088-564-144	96	2300-0067	216	2410-0059	219	2510-0007	119
20J	264	2303B-P	108	2410-0060	219	2510-0017	119
20N62230	236	2304B-P	108	2410-0061	219	2510-0029	119
20N62250	236	2314B-P	108	2410-0062	219	2510-0030	120
20N62280	236	2330B-P	108	2410-0063	219	2510-0031	120
20N62330	236	2331B-CP	108	2410-0064	219	2520-0209	216
20N62350	236	2340B-P	108	2410-0065	219	2520-0210	216
20N62380	236	2345B-P	108	2410-0066	219	2520-0211	216
20N62430	236	234-2916	101	2410-0067	219	2520-0213	216
20N62450	236	234-2926	101	2410-0068	219	2520-0214	216
20N62480	236	234-2936	101	2410-0069	219	2520-0215	216
20N62530	236	234-2946	101	2410-0070	219	2520-0216	217
20N62550	236	234-3916	101	2410-0071	219	2520-0217	217
20N62580	236	234-3926	101	2410-0072	219	2520-0218	217
20N62630	236	234-3936	101	2410-0073	219	2520-0219	217
20N62650	236	234-3946	101	2410-0074	219	2526-0011	54
20N62680	236	2351B-P	108	2410-0075	219	2535S	105
2102020	254	2354B-CP	108	2410-0076	219	2541-0045	128
2102030	254	2359B-P	108	2410-0077	219	2541-0046	128
2130P-A055	122	2359B-PY	108	2410-0078	219	2541-0048	128
2130P-A079	122	2404-0019	119	2410-0079	219	2541-0049	128
2130P-D183	122	2404-0030	119	2410-0080	219	2541-0050	128
2130P-D355	122	2404-0419	124	2410-0081	219	2541-0051	128
2130P-D359	122	2404-0427	124	2410-0082	219	2541-0053	128
2130P-D359	122	2410-0021	219	2410-0083	219	2541-0054	128
2130P-D395	122	2410-0022	219	2410-0084	219	2541-0055	128
2130P-D399	122	2410-0023	219	2410-0085	219	2541-0065	128
2130PX	122	2410-0024	219	2410-0086	219	2545S	105
2132P-D183	123	2410-0025	219	2410-0087	219	2549-0042	128
2132P-D355	123	2410-0026	219	2410-0088	219	2549-0043	128
2132P-D359	123	2410-0027	219	2410-0089	219	255-223	100
2132P-D395	123	2410-0028	219	2410-0090	219	255-313	100
2132P-D399	123	2410-0029	219	2410-0091	219	255-323	100
2132PX	123	2410-0030	219	2410-0092	219	255-413	100
2133P-D355	123	2410-0031	219	2410-0093	219	255-568	100
2133P-D395	123	2410-0032	219	2410-0094	219	255-613	100
2133PX	123	2410-0033	219	2410-0095	219	255-623	100
2150P-D05AC	124	2410-0034	219	2410-0096	219	255-646	100
2150P-D35DC	124	2410-0035	219	2410-0097	219	2640-0001	249
2150P-D39DC	124	2410-0036	219	2410-0098	219	2640-0002	249
2150PX	124	2410-0037	219				
2160-0038	86, 119						

# Index

Part Number	Page	Part Number	Page	Part Number	Page	Part Number	Page
2640-0003	249	3010-0004	71	30AN1.2	200	3300-0093	73
2640-0004	249	3010-0005	71	30AN1.8	200	3300-0094	73
2640-0005	249	3010-0006	71	30AN2.4	200	3300-0098	73, 124
2640-0007	249	3010-0010	71	30B4SNF70E35	232	3300-0102	117
2640-0008	249	3010-0014	71	30DT0.5	163, 200	3300-0103	117
2640-0009	249	3010-0020	71	30DT0.75	163, 200	3301-0001	73, 124
2640-0010	249	3010-0061	54	30DT10	163	3305-0011	216, 225
2640-0011	249	3010-0064	54	30DT15	163	3305-0112	248
2640-0014	249	3010-0066	54, 71	30DT1.0	163, 200	3312-0004	117
2642-0001	118	3010-0067	54, 71	30DT1.5	163, 200	3312-0005	117
27101612	198	3010-0068	71	30DT20	163	3316-0002	73
2728-1001	73, 121	3010-0084	54	30DT2.0	163	3320-0064	104
2729-1001	73, 121	3010-0167	54	30DT2.5	163	3320-0065	248
2729-1002	73, 121	3010-0168	54	30DT3.0	163	3324-1001.05	242
2729-1003	73, 121	3011-0006	71	30DT4.0	163	3324-1001.1	242
2729-1005	73, 121	3011-0021	71	30DT5.0	163	3324-1001.15	242
2729-1006	73, 121	301AF0.4-65	198	30DT7.5	163	3324-1001.2	242
27302489	197	301AF0.7-80	198	30FCX02	182	3324-1001.25	242
27302492	197	301AF0.7-80W	198	30FCX03	182	3324-1001.3	242
2738-1001	73, 121	301AF1.2-105C	198	30FCX04	182	3324-1001.35	242
2738-1002	73, 121	301AF1.6-100	198	30FCX05	182	3324-1001.4	242
2738-1003	73, 121	301AF5.0-70	198	30FCX06	182	3324-1001.45	242
2738-1004	73, 121	301AFD0.7-80	198	30HAF01110	197	3324-1001.5	242
2739-1001	73, 121	301AFD1.2-105	198	30HAF01480	197	3324-2000.85	242
2739-1002	73, 121	301AFD1.6-100	198	30HAF01570	197	3324-2001.05	242
2739-1003	73, 121	301AFUSA0.5	198	30HAF01-65	197	3324-2001.1	242
2739-1004	73, 121	301AFUSA1.0	198	30HAF007-80	197	3324-2001.15	242
2739-1005	73, 121	301AFUSA2.0	198	30HCX10	176	3324-2001.2	242
2739-1006	73, 121	301AFUSA3.0	198	30HCX12	176	3324-2001.25	242
2739-1009	73, 121	301MNF-W	198	30HCX18	176	3324-2001.3	242
2740-1001	73, 121	3020-0008	54	30HCX2	176	3324-2001.35	242
2740-1002	73, 121	3020-0009	54, 71	30HCX3	176	3324-2001.4	242
2740-1005	73, 121	3021-0006	220	30HCX4	176	3324-2001.45	242
2740-1007	73, 121	3040-0015	203	30HCX6	176	3324-2001.5	242
2741-1001	73, 121	3040-0016	203	30HCX8	176	3341-0001	117
2741-1002	73, 121	3040-0017	203	30HCX9	176	3341-0002	117
2741-1003	73, 121	3040-0018	203	30PFAF008-80	198	3341-0003	117
2741-1004	73, 121	3040-0019	203	30PFAF008-80BL	198	3341-0004	117
2741-1005	73, 121	3040-0020	203	30PFAF013-105	198	3350-0021	120
2741-1007	73, 121	30-CR-13	173	30PFAF013-105BL	198	3350-0022	120
2801-0001	86	30-CR-23	173	30Q2603-20	201	3350-0032	237
2801-0002	86	30-CR-25	173	30Q3579A	137	3350-0033	120
2850-0027	217	30-CR-45	173	30Q3834	157, 202	3350-0034	237
28541	264	30-DC010	170	32100010	202	3350-0035	237
28651	264	30-DC018	170	32100050	202	3350-0040	237
28J	264	30-DC023	170	32100200	198	3350-0042	237
280C02	185	30-DC-00	170	32100510	202	3350-0043	237
280C03	185	30-DC-01	170, 173	32100530	202	3350-0044	237
280C04	185	30-DC-02	170, 173	32100550	202	3350-0045	237
280C06	185	30-DC-03	170, 173	32195Q3269	198	3350-0046	237
280C08	185	30-DC-04	170, 173	32J	264	3350-0056	237
280C12	185	30-DC-05	170, 173	32PIFA250	198	3350-0057	237
280C16	185	30-DC-06	170, 173	3300-0001	73, 124	3350-0058	237
2910-0026	224	30-DC-07	170, 173	3300-0002	73, 124	3350-0059	237
2910-0037	227	30-DC-08	170, 173	3300-0015	73, 124	3350-0060	237
3000-350	98	30-DC-10	170, 173	3300-0016	73, 124	3350-0061	237
3010-000	100	30-DC-12	170, 173	3300-0082	88	3350-0062	237
3010-0001	71	30-DC-015	170, 173	3300-0084	117	3350-0068	237
3010-0002	71	30-DC-035	170	3300-0087	88	3350-0069	237
3010-0003	71	30AN0.6	200	3300-0088	88	3350-0071	237

# Index

Part Number	Page	Part Number	Page	Part Number	Page	Part Number	Page
3350-0072	237	3350-0151B	236	3351-0039	236	33812D	227
3350-0073	237	3350-0151N	236	3351-0040	236	3381-0010	239
3350-0074	237	3350-0152B	236	3351-0041	236	3381-0011	239
3350-0075	237	3350-0152N	236	3351-0042	236	3381-0013	239
3350-0076	237	3350-0153B	236	3351-0043	236	3381-0016	238
3350-0077	237	3350-0153N	236	3365-0002	241	3381-0018	241
3350-0079	237	3350-0154B	236	3365-0004/24	241	3381-0021	238
3350-0082	237	3350-0154N	236	3365-0004/36	241	3381-0032	241
3350-0085	237	3350-0155B	236	3365-0004/47	241	3381-0034	241
3350-0112	237	3350-0155N	236	3365-0005/24	241	3381-0036	238
3350-0113	237	3350-0156B	236	3365-0005/36	241	3381-0043	238
3350-0114	237	3350-0156N	236	3365-0005/47	241	3381-0047	241
3350-0115	237	3350-0157B	236	3365-0007/14	241	3381-0018W	241
3350-0116	237	3350-0157N	236	3365-0007/24	241	3381-0032W	241
3350-0117	237	3350-0158B	236	3365-0007/36	241	3381-0043L	238
3350-0126	120	3350-0158N	236	3371-0019	233	3385-1500	239
3350-0127	120	3350-0159B	236	3371-0028	233	3385-2300	239
3350-0128	120	3350-0159N	236	3371-0036	235	3385-3000	239
3350-0131	237	3350-0160B	236	3371-0038	235	3385-3500	239
3350-0132	237	3350-0160N	236	3371-0040	235	3385-4000	239
3350-0134	120	3350-0161B	236	3371-0034S	235	3385-4500	239
3350-0034A	236	3350-0161N	236	3371-0036R	235	3385-5000	239
3350-0035A	236	3350-0162B	236	3371-0037R	235	3385-5500	239
3350-0040A	236	3350-0162N	236	3371-0038R	235	3385-6000	239
3350-0043A	236	3350-0163B	236	3371-0039R	235	3385-7000	239
3350-0046A	236	3350-0163N	236	3371-0040R	235	338D	227
3350-0056A	236	3350-0164B	236	3371-0041R	235	3390-0006	116
3350-0057A	236	3350-0164N	236	3371	233	3390-0007	116
3350-0058A	236	3350-0165B	236	3375-0008	118	3390-0037	116
3350-0059A	236	3350-0165N	236	3375-0012	118	3390-0053	116
3350-0071A	236	3350-0166B	236	3375-0021	118	3390-0076	116
3350-0072A	236	3350-0166N	236	3375-0025	124	3390-0079	116
3350-0073A	236	3350-0167B	236	3375-0015-10	118	3390-0081	116
3350-0079A	236	3350-0167N	236	3375-0015-2	118	3390-0102	116
3350-0079F	237	3350-0168B	236	3375-0015-3	118	3390-0062D	116, 124
3350-0082A	236	3350-0168N	236	3375-0015-4	118	3390-0063D	116
3350-0082F	237	3350-0169B	236	3375-0015-5	118	3390-0067D	116
3350-0085A	236	3350-0169N	236	3375-0015-6	118	3390-0071D	116
3350-0085F	237	3350-0170B	236	3375-0015-7	118	3390-0072D	116
3350-0112A	236	3350-0170N	236	3375-0015-8	118	3390-0104/3A	116
3350-0113A	236	3350-0171B	236	3375-0015-9	118	33942	227
3350-0114A	236	3350-0171N	236	3375-0017-10	118	3396-0006	117
3350-0142B	236	3350-0172B	236	3375-0017-2	118	3396-0011	117
3350-0142N	236	3350-0172N	236	3375-0017-3	118	3396-0014	117
3350-0143B	236	3350-0173B	236	3375-0017-4	118	3396-0025	117
3350-0143N	236	3350-0173N	236	3375-0017-5	118	3396-0031/2.1	116
3350-0144B	236	3351-0005	237	3375-0017-6	118	3396-0033/2.3	116
3350-0144N	236	3351-0006	237	3375-0017-7	118	3396-0034/1.8	116
3350-0145B	236	3351-0007	237	3375-0017-8	118	3410-0041	56, 57, 62
3350-0145N	236	3351-0013	237	3375-0017-9	118	3410-0042	56, 57, 58, 62
3350-0146B	236	3351-0014	237	3376-0870	234	3410-0043	224
3350-0146N	236	3351-0015	237	3376-0871	234	3410-0044	224
3350-0147B	236	3351-0016	237	3376-1170	234	3420-0003	71
3350-0147N	236	3351-0020	237	3376-1171	234	3420-0004	71
3350-0148B	236	3351-0022	237	3376-1670	234	3420-0010	71
3350-0148N	236	3351-0024	237	3376-1671	234	3420-0023	71
3350-0149B	236	3351-0026	237	3377-1170	234	3420-0024	71
3350-0149N	236	3351-0035	236	3377-1171	234	3420-0025	71
3350-0150B	236	3351-0036	236	3377-1670	234	3430-0037	112
3350-0150N	236	3351-0037	236	3377-1671	234		
		3351-0038	236				

# Index

Part Number	Page	Part Number	Page	Part Number	Page	Part Number	Page
3430-0332	15, 16, 17, 20, 25, 26, 27, 28, 30, 38, 39, 43, 44, 46, 47, 48, 49	3430-0838	56, 57, 58	350640-020	231	3800-0089	236
		3430-0480SP	12, 17, 32, 43	350640	231	3800-0090	236
		3430-0481SP	19, 37	350660	231	3800-0091	236
3430-0333	13, 22, 23, 24, 44	3430-0482SP	17, 49	350680-020	231	3800-0092	236
3430-0334	11, 12	3430-0673CSP	59	350680	231	3800-0093	236
3430-0380	71	3430-0674CSP	59	352000-020	231	3800-0094	236
3430-0381	71	3430-0692-02	56, 57, 58	352080-1	231	3800-0095	236
3430-0384	71	3430-0754V	223	352080	231	3800-0096	236
3430-0386	71	3430-0755V	223	352180-1	231	3800-0097	236
3430-0387	71	3430-0840V	220	352180	231	38027	227, 260
3430-0390	71	3470-0101	245	3522000	231	3812D	227
3430-0437	71	3470-0102	245	3522040	231	383818	198
3430-0445	34	3470-0103	245	3522040-1	231	38D	227
3430-0456	54	3470-0104	245	3522060	231	3942	227
3430-0464	46, 47, 50	3470-0106	245	3522060-1	231	3A100114	257
3430-0476	44	3470-0107	245	3522100	231	3A10034	257
3430-0477	44	3470-0201	245	3522100-1	231	3A100	257
3430-0478	44	3470-0202	245	3522120	231	3A112114	257
3430-0479	44	3470-0203	245	3522120-020	231	3A112	257
3430-0500	36	3470-0204	245	3522120-1	231	3A114100	257
3430-0537	18, 19	3470-0205	251	3522140	231	3A114112	257
3430-0540	71, 72	3470-0206	245	3522140-020	231	3A11434	257
3430-0589	15, 16, 17, 20, 25, 26, 27, 28, 30, 32, 38, 39, 43, 44, 46, 47, 48, 49, 52	3470-0207	245	3522140-1	231	3A114	257
		3470-0208	246	3522160	231	3A1214	257
		3470-0209	246	3522160-020	231	3A1234	257
3430-0590	13, 22, 23, 24, 44, 52	3470-0301	246	3522160-1	231	3A1238	257
3430-0591	11, 12, 52	3470-0302	246	3522221	231	3A1258	257
3430-0592	54	3470-0303	246	3522221-1	231	3A12	257
3430-0593	34, 52	3470-0305	246	354230	229	3A1412	257
3430-0601	36, 37, 52	3470-0306	246	356040	231	3A1438	257
3430-0604	21, 40, 42, 52	3470-0307	246	356041	231	3A14	257
3430-0633	124	3470-0308	246	356060	231	3A1814	257
3430-0634	124	3470-0401	246	356061	231	3A18316	257
3430-0635	56, 57	3470-0402	246	356240	231	3A1838	257
3430-0636	71	3470-0403	246	356241	231	3A200	257
3430-0645	105	3470-0500	247	356260	231	3A34100	257
3430-0646	18, 19, 52	3470-0601	246	356261	231	3A3412	257
3430-0650	54	3470-0602	246	356640-020NB	231	3A3414	257
3430-0659	56, 57	3470-0603	246	356660-020NB	231	3A3438	257
3430-0675	59	3470-0604	246	36J	264	3A3458	257
3430-0676	59	3470-0605	246	3800-0025	236, 237	3A34	257
3430-0690	56, 57	3470-0700	247	3800-0026	236, 237	3A3812	257
3430-0691	56, 57	3470-0702	247	3800-0029	236, 237	3A3814	257
3430-0692	56, 57, 58	3470-0708	247	3800-0035	120	3A38516	257
3430-0699	105	3470-0800	247	3800-0040	236, 237	3A3858	257
3430-0700	53	3470-0801	247	3800-0041	236, 237	3A38	257
3430-0754	223	3470-0900	247	3800-0042	236, 237	3AF1214	257
3430-0755	223	3470-0901	247	3800-0043	236, 237	3AF1234	257
3430-0757	56, 57, 58	34-006	100	3800-0044	236, 237	3AF1238	257
3430-0768	238	34-007	100	3800-0045	236, 237	3AF1258	257
3430-0779	14, 50	3502420	231	3800-0046	236, 237	3AF12	257
3430-0790	224	3502440	231	3800-0047	236, 237	3AF1438	257
3430-0791	61	3502460	231	3800-0048	236, 237	3AF14	257
3430-0792	61	350401	231	3800-0065	236, 237	3AF3412	257
3430-0793	61	350420-020	231	3800-0066	236, 237	3AF3438	257
3430-0796	44	350440-020	231	3800-0067	236, 237	3AF3458	257
3430-0797	54	350460-020	231	3800-0074	119	3AF34	257
3430-0807	234	350480-020	231	3800-0086	236	3AF3812	257
3430-0823	234	350480	231	3800-0087	236	3AF3814	257
		350620-020	231	3800-0088	236	3AF38	257

# Index

Part Number	Page	Part Number	Page	Part Number	Page	Part Number	Page
3B100	124, 260	3EL34HB	258	3M1418	258	3SE12	257
3B12	227, 260	3EL34	257	3M14	258	3SE14	257
3B3412	260	3EL3812	257	3M18	258	3SE200	257
3B34	260	3EL3814	257	3M200	258	3SE3445	258
3B35	260	3EL3812F	257	3M3412	258	3SE34	257
3C100	260	3EL3814F	257	3M3438	258	3SE38	257
3C12NPT	260	3EL3814HB	258	3M34	258	3SHM100	259
3C12	260	3EL3858	257	3M3814	258	3SHM112	259
3C14	260	3EL38F	257	3M3818	258	3SHM114	259
3C34	260	3EL38HB	258	3M38	258	3SHM1238	259
3C38	260	3EL38	257	3N34	260	3SHM1258	259
3C58	260	3EL58HB	258	3NB1612	227	3SHM12	259
3D3412	259	3ELD3412	259	3NB1614	227	3SHM14	259
3D3438	259	3ELD3414	259	3NF1614	227	3SHM200	259
3D3458	259	3ELD3438	259	3NS12	264	3SHM34	259
3D34	259	3ELD34	259	3NS17	264	3SHM38	259
3E3412	259, 260	3F100	258	3NS21	264	3SHM58	259
3E3438	259	3F112	258	3NS28	264	3T100	259
3E34	259, 260	3F114	258	3NS32	264	3T112	259
3EL10012	257	3F12	258	3NS4	264	3T114	259
3EL10034	257	3F14	258	3NS7	264	3T1234T	259
3EL100	257	3F18	258	3NS8	264	3T1238T	259
3EL112HB	258	3F200	258	3NTL12	227	3T1238	259
3EL112	257	3F34	258	3NTL14	227	3T12C	227
3EL11434	257	3F38	258	3NTL34	227	3T12T	259
3EL114100	257	3FC100	258	3NTL38	227	3T12	259
3EL114112	257	3FC112	258	3NTL58	227	3T1438T	259
3EL114HB	258	3FC114	258	3NTT12	227	3T1438	259
3EL114	257	3FC12	258	3NTT34	227	3T14T	259
3EL1214	257	3FC200	258	3NTT38	227	3T14	259
3EL1214HB	258	3FC34	258	3NTT58	227	3T200	259
3EL1234	257	3G3412	259	3Q12	260	3T3412T	259
3EL1238	257	3G3414	259	3Q14	260	3T3412	259
3EL1234F	257	3G34	259	3R12	233	3T3438T	259
3EL1238HB	258	3GTT1214	258	3RB10012	258	3T3458T	259
3EL1258	257	3GTT3414	258	3RB10034	258	3T34C	227
3EL1258F	257	3H34	259	3RB11234	258	3T34F	259
3EL12HB	258	3HM1214	259	3RB112100	258	3T34T	259
3EL12	257	3HM1238	259	3RB112114	258	3T34	259
3EL1412	257	3HM14	259	3RB11434	258	3T3812T	101, 259
3EL1438	257	3HM3814	259	3RB114100	258	3T3812	259
3EL14316	257	3HM516	259	3RB1214	258	3T38C	227
3EL14316F	257	3HM5838	259	3RB1218	258	3T38T	259
3EL1438F	257	3I34	260	3RB1238	258	3T38	259
3EL14F	257	3J3412	259	3RB1418	258	3T58	259
3EL14HB	258	3K8412	227	3RB20034	258	3TT100	258
3EL14	257	3K8414	227	3RB200100	258	3TT112	258
3EL1814	257	3K8438	227	3RB200112	258	3TT114	258
3EL1838	257	3LL100	258	3RB200114	258	3TT12	258
3EL200HB	258	3LL112	258	3RB300200	258	3TT14	258
3EL200	257	3LL114	258	3RB3412	258	3TT200	258
3EL34100	257	3LL12	258	3RB3414	258	3TT34	258
3EL3412	257	3LL200	258	3RB3418	258	400059P	226
3EL3414	257	3LL34	258	3RB3438	258	400059	226
3EL3412F	257	3M100	258	3RB3814	258	400069P	226
3EL3438	257	3M112	258	3RB3818	258	400069	226
3EL3458	257	3M114	258	3RW1116A	260	4001C-H	65
3EL3458F	257	3M1214	258	3SE100	257	4001C	65
3EL3458HB	258	3M1238	258	3SE112	257	4001N-E2H	66
3EL34F	257	3M12	258	3SE114	257	4001N-EH	66



# Index

Part Number	Page	Part Number	Page	Part Number	Page	Part Number	Page
4001N-H	65	4200-0213N	222	4231N-B101S	223	4243N-B528V	222
4001N	65	4200-0214N	222	4231N-B101T	223	4247N-B111	223
4001XL-E2H	66	4200-0215N	222	4231N-B102D	223	4247N-B119	223
4001XL-EH	66	4200N-0017	201, 228	4231N-B102S	223	4247N-B121	223
4001XL-H	65	4200N-0018	201, 228	4231N-B102T	223	4247N-B129	223
4001XL	65	4200N-0020	226	4231N-B103D	223	4247N-C111	223
402105-030	201	4200N-0021	226	4231N-B103S	223	4247N-C119	223
402265P	221	4200N-0023	226	4231N-B103T	223	4247N-C121	223
4081B0N	226	4200N-0024	226	4240N-B010	223	4247N-C129	223
40867BN	226	4200N-0025	226	4240N-B010V	223	4263N-B323D	222
40868BN	226	4200N-0026	226	4240N-B020	223	4263N-B323DV	222
40J	264	4201N-B102	223	4240N-B020V	223	4263N-B323S	222
4101C-25	70	4201N-B103	223	4240N-B121D	223	4263N-B323SV	222
4101C-H	65	4201N-B104	223	4240N-B121S	223	4263N-B324D	222
4101C	65	4211-035	97	4240N-B122D	223	4263N-B324DV	222
4101N-E2H	66	4213-0504V	216	4240N-B122S	223	4263N-B324S	222
4101N-EH	66	4214-1502V	220	4240N-B123D	223	4263N-B324SV	222
4101N-H	65	4214-1503V	220	4240N-B123S	223	4263N-B523D	222
4101N	65	4214-1504V	220	4240N-F110	223	4263N-B523DV	222
4101XL-25	70	4214-1507V	220	4240N-F110V	223	4263N-B523S	222
4101XL-E2H	66	4214-1508V	220	4240N-F120	223	4263N-B523SV	222
4101XL-EH	66	4214-2502V	220	4240N-F120V	223	4263N-B524D	222
4101XL-H	65	4214-2503V	220	4240N-F150	223	4263N-B524DV	222
4101XL	65	4214-2504V	220	4240N-F150V	223	4263N-B524S	222
4111-035	97	4214-2507V	220	4241N-B120U	223	4263N-B524SV	222
413003	228	4214-2508V	220	4241N-B121D	222	430001	226
413004	228	4221N-B122	221	4241N-B121S	222	430002	226
413005	228	4221N-B122V	221	4241N-B121T	222	430201V	226
413013	228	4221N-B123	221	4241N-B122D	222	430201	226
413014	228	4221N-B123V	221	4241N-B122S	222	430202V	226
413015	228	4221N-B124	221	4241N-B122T	222	430202	226
413016	228	4221N-B124V	221	4241N-B123D	222	44J	264
413018	228	4221N-B127	221	4241N-B123S	222	461021-1	244
4200-0010	225	4221N-B127V	221	4241N-B123T	222	461031-4	244
4200-0019	228	4221N-B128	221	4242N-B300	222	461031-3	244
4200-0020	225	4221N-B128V	221	4242N-B322D	222	461031-2	244
4200-0025	225	4222N-B322	221	4242N-B322S	222	461031-1	244
4200-0030	225	4222N-B323	221	4242N-B322T	222	4621AA10000	243
4200-0040	225	4222N-B324	221	4242N-B323D	222	4621AA11313	243
4200-0050	225	4223N-B322	221	4242N-B323S	222	4621AA20000	243
4200-0060	201	4223N-B322V	221	4242N-B323T	222	4621AA30000	243
4200-0061	201	4223N-B323	221	4243N-B322	222	4621AA31414	243
4200-0062	201	4223N-B323V	221	4243N-B322V	222	4621AA40000	243
4200-0063	201	4223N-B324	221	4243N-B323	222	4621AA41414	243
4200-0004E	225	4223N-B324V	221	4243N-B323V	222	4621AA41515	243
4200-0004V	225	4223N-B327	221	4243N-B324	222	4621AA10000-100	243
4200-0010V	225	4223N-B327V	221	4243N-B324V	222	4621BA01313	243
4200-0015N	228	4223N-B328	221	4243N-B327	222	4621BA11313	243
4200-0016N	228	4223N-B328V	221	4243N-B327V	222	4621BA41414	243
4200-0020V	225	4223N-B522	221	4243N-B328	222	4622AA40000	243
4200-0030V	225	4223N-B522V	221	4243N-B328V	222	4622AA50000	243
4200-0040V	225	4223N-B523	221	4243N-B522	222	4622AA51616	243
4200-0050V	225	4223N-B523V	221	4243N-B522V	222	4622AA61717	243
4200-0111N	222	4223N-B524	221	4243N-B523	222	4622BA51616	243
4200-0112N	222	4223N-B524V	221	4243N-B523V	222	4622BA61717	243
4200-0113N	222	4223N-B527	221	4243N-B524	222	4622BA50000-100	243
4200-0114N	222	4223N-B527V	221	4243N-B524V	222	4622BA50000-200	243
4200-0115N	222	4223N-B528	221	4243N-B527	222	463020	244
4200-0211N	222	4223N-B528V	221	4243N-B527V	222	463051	244
4200-0212N	222	4231N-B101D	223	4243N-B528	222	463061	244

# Index

Part Number	Page	Part Number	Page	Part Number	Page	Part Number	Page
463080N	244	56454136	248	738100	261	7RB3412	261
464621AA10000	243	56454137	248	738112	261	7RB3414	261
464621AA20000	243	56454232	248	7433-2502	224	7RB3814	261
464621AA30000	243	56454233	248	7433-2503	224	7SE100	261
464621AA4000	243	56454234	248	7433-2515	224	7SE112	261
464622AA51616	243	56454235	248	7433-2601	224	7SE114	261
464622AA61717	243	56454236	248	7433-2608	224	7SE12	261
464622BA51616	243	56454237	248	7433-2610	224	7SE14	261
464622BA61717	243	56J	264	7433-2613	224	7SE200	261
46463020	244	626012	260	7433-3314	224	7SE300	261
46463024	244	626014	260	7433-3316	224	7SE34	261
46463051	244	626320N	260	7560C-GM15	68	7SE38	261
46463061	244	626325N	260	7560C-GM30	68	7TT100	261
46473070	244	626425N	260	7560C	67	7TT112	261
473070	244	626525N	260	7560N-GM15	68	7TT114	261
48J	264	626532N	260	7560N-GM30	68	7TT12	261
4JM	264	626632N	260	7560N	67	7TT14	261
500615-060	233	626638N	260	7560XL-GM15	68	7TT200	261
502069	233	626651N	260	7560XL-GM30	68	7TT300	261
5042015	248	626751N	260	7560XL	67	7TT34	261
5042016	248	627320N	260	7700C	69	8000-0003	118
5042017	248	627325N	260	7700N	69	8000-0007	116
5042019	248	627420N	260	7700XL	69	8000-0008	116
504203-HYP	233	627425N	260	78-100	249	8000-0010	118
504210	233	627432N	260	78-112	249	8000-0015	118
5059-1310-D011	90	627525N	260	78-114	249	8000-0017	118
5059-1311-D011	90	627532N	260	78-12	249	8000-0018	118
5059-3610-D011	90	627632N	260	78-14	249	8000-0021	118
5059-3611-D011	90	627638N	260	78-200	249	8000-0043	118
506530V	240	627751N	260	78-300	249	8000-0056	87
506531V	240	64J	264	78-34	249	8000-343-236	91
506532V	240	6500C	67	78-38	249	8000-533-236	93
520005	228	6500N	67	7F100	261	8000-533-250	93
5206C-H	112	6500XL	67	7F12	261	8000-541-236	91
5206C	112	65-BS205	137, 161, 167, 201	7F14	261	8000-542-136	91
5210C-H	112	65MN011X1.3	202	7F18	261	8000-543-136	91
5210C	112	65VBS0113-13	202	7F200	261	8000-543-138	91
52169	233	6JM	264	7F34	261	8000-543-210	92
52520005	228	6J	264	7F38	261	8000-543-220	92
52J	264	7100112	261	7FC100	261	8000-543-236	91
5315C-HX	113	7100400	261	7FC112	261	8000-543-238	91
5315C-X	113	7112134	261	7FC12	261	8000-543-250	92
5320C-HX	113	7114158	261	7FC14	261	8000-543-290	92
5320C-X	113	712112	261	7FC200	261	8000-543-936	91
5321C-H	114	712118	261	7FC300	261	8000-547-189	91
5321C	114	712200	261	7FC34	261	8000-643-236	91
5322C-H	114	714112	261	7LL100	261	8006-543-250	92
5322C	114	7141200	261	7LL112	261	8007-543-836	94
5324C-H	113	714300	261	7LL114	261	8007-543-850	94
5324C	113	714400	261	7LL12	261	8007-591-236	94
5325C-HX	113	714600	261	7LL14	261	8007-593-836	94
5325C-X	113	7200200	261	7LL200	261	8007-593-850	94
5330C-HX	113	7200212	261	7LL300	261	80112-F-00PP	227
5330C-X	113	7200300	261	7LL34	261	801-F-00PP	227
53702	114	7200312	261	7RB10012	261	8020-503-250	93
53703	115	7200400	261	7RB10034	261	8020-513-236	93
56454132	248	7200500	261	7RB1214	261	8020-833-238	93
56454133	248	7200600	261	7RB1238	261	8027	227, 260
56454134	248	734138	261	7RB1418	261	8030-813-239	91
56454135	248	734400	261	7RB200112	261	8030-863-239	93

# Index

Part Number	Page	Part Number	Page	Part Number	Page	Part Number	Page
8034-F-00PP	227	90A2CMxxE00	196	9205C	18	9306C-HM3C	38
8050-305-426	100	90A2CMxxE25	196	9206C	20	9306C-HM3C-3U	39
8090-212-246	93	90A2CMxxE40	196	9206S	20	9306C-HM5C	38
8090-801-278	93	90A2CMxxE65	196	9208C	21	9306C-HM5C-3U	39
8090-802-289	93	90A2CMxxE80	196	9213P	23	9306S-HM1C	38
8090-902-278	93	90A2FPx.x	195	9232C-SP	59	9306S-HM1C-3U	39
8095-902-260	93	90B1CMxxE00	196	9233C-SP	59	9306S-HM3C	38
8304B-HM5C	126	90B1CMxxE25	196	9243P-SP	58	9306S-HM3C-3U	39
8304BV	126	90B1CMxxE40	196	9260P-R	24	9306S-HM5C	38
8304B	126	90B1CMxxE65	196	9260P	24	9306S-HM5C-3U	39
8630001	244	90B1CMxxE80	196	9262C-C	25	9307C-GM10	40
8630011	244	90B1FPx.x	195	9262S-C	25	9307C-GM12	40
8630020S	244	90B2CM02E00	169	9262S-CR	25	9307CWS-GM12	41
8630024S	244	90B2CM03E00	169	9263C-BT	27	9308C-GM25	42
8630D24S	244	90B2CM04E00	169	9263C-C	27	9308C-PM15	42
8-005-01	101	90B2CM05E00	169	9263C-CR	27	9308CX	42
8-006-01	101	90B2CM06E00	169	9263C-CR-SP	26	9325-043-101	98
8-007-01	101	90B2CM07E00	169	9263C-CR-SP-B	26	9332C-HM1C-SP	60
8-126-00	101	90B2CM10E00	169	9263C-C-SP	26	9332C-HM5C-SP	60
8-145-00	101	90B2CM15E00	169	9263S-C	27	9342P-HM1C-5SP	57
8-150-01	101	90B2CM20E00	169	9263S-CR	27	9342P-HM5C-5SP	57
8-205-00	101	90B2CM30E00	169	9263S-C-SP	26	9343P-GM10-SP	57
8-727-00	104	90B2CMxxE00	196	9302C-HM1C	28	9343P-GM10Y-SP	57
8JM	264	90B2CMxxE25	196	9302C-HM2C	28	9343P-GM6-SP	57
8J	264	90B2CMxxE40	196	9302C-HM4C	28	9343P-GM6Y-SP	57
90029	11	90B2CMxxE65	196	9302CT-GM1	28	9402C-540	44
9006C-O	11	90B2CMxxE80	196	9302S-HM1C	28	9402C-1000	44
9006C-O-SP	12	90B2FPx.x	195	9302S-HM2C	28	9402C-1000L	44
9006P-O	13	90FFB12	249	9302S-HM4C	28	9402C-1000S	44
9008C-O	11	90FFB14	249	9302ST-GM1	28	9402C-540Q	44
9008P-O	13	90FFB18	249	9303C-HM1C	30	9402C-540S	44
9016C-O	11	90FFB38	249	9303C-HM1C-SP	32	9403C-540	44
9016C-O-SP	12	90FFL12	249	9303C-HM2C	30	9403C-1000	44
9016P-O	13	90FFL14	249	9303C-HM2C-SP	32	9403C-1000L	44
9018C-O	11	90FFL18	249	9303C-HM3C	30	9403C-1000L-SP	43
9018P-O	13	90FFL38	249	9303C-HM3C-SP	32	9403C-1000-MTZ	44
9028C-O	11	90FMB12	249	9303C-HM4C	30	9403C-1000-MTZ-KIT	44
9028C-O-SP	12	90FMB14	249	9303C-HM4C-SP	32	9403C-1000S	44
902-100	98	90FMB38	249	9303C-HM5C	30	9403C-1000-SP	43
902-200	98	90FML12	249	9303C-HM5C-SP	32	9403C-540Q	44
9047C-BSP	14	90FML14	249	9303P-HM1C	34	9403C-540Q-SP	43
9047C-SP	14	90FML38	249	9303P-HM2C	34	9403C-540S	44
9047C	14	90LD03F110	190	9303P-HM3C	34	9403C-540-SP	43
90-HBF	249	90LD04F110	190	9303P-HM4C	34	9403C-540S-SP	43
90A1CMxxE00	196	90LD05F110	190	9303P-HM5C	34	9403P-540	44
90A1CMxxE25	196	90LD06F110	190	9303S-HM1C	30	9403P-1000	44
90A1CMxxE40	196	9202C	15	9303S-HM1C-SP	32	9403P-1000L	44
90A1CMxxE65	196	9202S-R	15	9303S-HM2C	30	9403P-1000S	44
90A1CMxxE80	196	9202S	15	9303S-HM2C-SP	32	9403P-540Q	44
90A1FPx.x	195	9203C-R	16	9303S-HM3C	30	9403P-540S	44
90A2CM02E00	169	9203C-R-SP	17	9303S-HM3C-SP	32	9403S-540	44
90A2CM03E00	169	9203C-SP	17	9303S-HM4C	30	9403S-1000	44
90A2CM04E00	169	9203C	16	9303S-HM4C-SP	32	9403S-1000L	44
90A2CM05E00	169	9203P-S	22	9303S-HM5C	30	9403S-1000S	44
90A2CM06E00	169	9203P-SR	22	9303S-HM5C-SP	32	9403S-540Q	44
90A2CM07E00	169	9203S-R	16	9305C-HM3C	36	9403S-540S	44
90A2CM10E00	169	9203S-SP	17	9305C-HM3C-BSP	37	94-389-01	97
90A2CM15E00	169	9203S	16	9305C-HM3C-SP	37	94-389-00	97
90A2CM20E00	169	9205C-BSP	19	9306C-HM1C	38	94-712-00	104
90A2CM30E00	169	9205C-SP	19	9306C-HM1C-3U	39		

# Index

Part Number	Page	Part Number	Page	Part Number	Page	Part Number	Page
94-716-00	104	9910-DBS200	83	9910-KIT2202	86	9950-16180	232
94-717-00	104	9910-DP423	74	9910-KIT2203	86	9950-16280	232
94-718-00	104	9910-DP423GRGI	74	9910-KIT2204	86	9950-16320	232
94-719-00	104	9910-DP573	74	9910-KIT2347	86	9950-100BA	254
94-720-05	104	9910-DP573GRGI	74	9910-KIT2349	86	9950-100BB	254
94-720-00	104	9910-DP763	74	9910-KIT2364	86	9950-100BD	255
94-721-00	104	9910-DP763GRGI	74	9910-KIT2365	86	9950-100BF	255
94-723-00	104	9910-GH50	88	9910-KIT2370	86	9950-100C	254
94-724-00	104	9910-GR40	88	9910-KIT2374	86	9950-100E	255
94-725-00	104	9910-GS25	74, 88	9910-KIT2376	86	9950-100G	255
94-732-00	104	9910-GS35S	74, 88	9910-KIT2378	86	9950-100H	255
94-733-00	104	9910-GS40GI	88	9910-KIT2388	86	9950-100NA	254
94-734-00	104	9910-GS50GI	88	9910-KIT2389	86	9950-100NB	254
94-735-00	104	9910-HYD1570	87	9910-KIT2408	86	9950-100ND	255
94-736-00	104	9910-HYD2495	87	9910-KIT2409	86	9950-100NF	255
94-737-00	104	9910-HYD5312	87	9910-KIT2423	86	9950-125BA	254
94-738-00	104	9910-KIT1640	87	9910-KIT2444	86	9950-125BB	254
9700B	126	9910-KIT1642	87	9910-KIT2445	86	9950-125BD	255
9700S	126	9910-KIT1702	86	9910-KIT2446	86	9950-125BF	255
9732C-SPX	60	9910-KIT1703	86	9910-KIT2456	86	9950-125C	254
9733C-SPX	60	9910-KIT1704	86	9910-KIT2457	86	9950-125E	255
9742P-050SPT	58	9910-KIT1706	86	9910-KIT2479	86	9950-125G	255
9742P-050SPT3	58	9910-KIT1707	86	9910-KIT2480	86	9950-125H	255
9742P-075SPT3	58	9910-KIT1708	86	9910-KIT55357	87	9950-125NA	254
9910-BMH50	88	9910-KIT1710	86	9910-RM40	88	9950-125NB	254
9910-D30	78	9910-KIT1711	86	9910-VDR50	88	9950-125ND	255
9910-D50	79	9910-KIT1720	86	9920-248	239	9950-125NF	255
9910-D70	75	9910-KIT1721	86	9920-261703-69	238	9950-150BA	254
9910-D115	75	9910-KIT1722	86	9920-35.1703.67	238	9950-150BB	254
9910-D135	76	9910-KIT1723	86	9920-35.1802.56	238	9950-150BD	255
9910-D160	76	9910-KIT1724	86	9920-KIT10/11	239	9950-150BF	255
9910-D250	77	9910-KIT1725	86	9940-9750NRL	125	9950-150C	254
9910-D252	77	9910-KIT1730	86	9940-9751NRL	125	9950-150E	255
9910-D403	78	9910-KIT1734	86	9940-9753NRL	125	9950-150G	255
9910-D503	79	9910-KIT1881	86	9950-0001	160	9950-150H	255
9910-D813	80	9910-KIT1882	86	9950-0022	203	9950-150NA	254
9910-D1064	80	9910-KIT1904	86	9950-0023	203	9950-150NB	254
9910-D1265	81	9910-KIT1908	86	9950-0024	201, 228	9950-150ND	255
9910-D1064GRGI	80	9910-KIT1916	86	9950-0027	201, 228	9950-150NF	255
9910-D115GR34	75	9910-KIT1917	86	9950-0028	203	9950-200BA	254
9910-D252GRGI	77	9910-KIT1919	86	9950-0030	244	9950-200BB	254
9910-D252GRGI58	77	9910-KIT1920	86	9950-0031	203	9950-200BD	255
9910-D252GRGIAP	77	9910-KIT1963	86	9950-0033	189	9950-200BF	255
9910-D30AP-A	78	9910-KIT1964	86	9950-08050	232	9950-200C	254
9910-D30-B-GRGI	78	9910-KIT1965	86	9950-08120	232	9950-200E	255
9910-D30GRGI	78	9910-KIT1972	86	9950-08240	232	9950-200G	255
9910-D403GRGI	78	9910-KIT1984	86	9950-075BA	254	9950-200H	255
9910-D503GRGI	79	9910-KIT1987	86	9950-075BB	254	9950-200NA	254
9910-D503GRGI34	79	9910-KIT1990	88	9950-075BD	255	9950-200NB	254
9910-D50AP-A	79	9910-KIT1992	86	9950-075BF	255	9950-200ND	255
9910-D50-B	79	9910-KIT2024	86	9950-075C	254	9950-200NF	255
9910-D70GR	75	9910-KIT2026	86	9950-075E	255	9950-300BA	254
9910-D813GRGI	80	9910-KIT2053	86	9950-075G	255	9950-300BB	254
9910-DBA110	81	9910-KIT2100	86	9950-075H	255	9950-300BD	255
9910-DBA140	82	9910-KIT2110	86	9950-075NA	254	9950-300BF	255
9910-DBA160	82	9910-KIT2111	86	9950-075NB	254	9950-300C	254
9910-DBA200	83	9910-KIT2113	86	9950-075ND	255	9950-300E	255
9910-DBS110	81	9910-KIT2114	86	9950-075NF	255	9950-300G	255
9910-DBS140	82	9910-KIT2200	86	9950-12060	232	9950-300H	255
9910-DBS160	82	9910-KIT2201	86	9950-12240	232	9950-300NA	254

# Index

Part Number	Page	Part Number	Page	Part Number	Page	Part Number	Page
9950-300NB	254	A1234S	262	A-200SS	254	ATR-RED	177
9950-300ND	255	A1234	257	A-300SS	254	ATR-WHITE	177
9950-300NF	255	A1238B	262	A-750SS	254	ATR-YELLOW	177
9950-55203	232	A1238S	262	AA10034P	262	ATW-11001	139
9951-2050B	248	A1238	257	AA100P	262	ATW-11002	139
9951-2050N	248	A1258B	262	AA112P	262	ATW-11003	139
9951-2075B	248	A1258S	262	AA114P	262	ATW-11004	139
9951-2075N	248	A1258	257	AA200P	262	ATW-11005	139
9951-2100B	248	A12B	262	AA34P	262	ATW-110015	139
9951-2100N	248	A12S	262	ADI-11001	149	AVI-11001	143
9951-2100UF	253	A12	257	ADI-11002	149	AVI-11002	143
9951-2125B	248	A1412B	262	ADI-11003	149	AVI-11003	143
9951-2125N	248	A1412S	262	ADI-11004	149	AVI-11004	143
9951-2150B	248	A1412	257	ADI-110015	149	AVI-11005	143
9951-2150N	248	A14316	257	AE2650	243	AVI-11006	143
9951-2200B	248	A1438B	262	AE2651	243	AVI-11008	143
9951-2200N	248	A1438S	262	AE2652	243	AVI-11010	143
9951-2200UF	253	A1438	257	AE2654	243	AVI-110015	143
9951-2300UF	253	A14516	257	AF1214	257	AVI-110025	143
9951-3050B	248	A14B	262	AF1234	257	AVI-8001	179
9951-3050N	248	A14S	262	AF1238	257	AVI-8002	179
9951-3075B	248	A14	257	AF1258	257	AVI-8003	179
9951-3075N	248	A1814B	262	AF12	257	AVI-8004	179
9951-3100B	248	A1814S	262	AF1438B	262	AVI-80015	179
9951-3100N	248	A1814	257	AF1438	257	AVI-80025	179
9951-3125B	248	A18316	257	AF14	257	AVI-OC-80025	187
9951-3125N	248	A1838B	262	AF3412	257	AVI-OC-80015	187
9951-3150B	248	A1838S	262	AF3438	257	AVI-OC-8004	187
9951-3150N	248	A1838	257	AF34	257	AVI-OC-8003	187
9951-3200B	248	A18516	257	AF3812	257	AVI-OC-8002	187
9951-3200N	248	A200	257	AF3814	257	AXI-11002	155
9A100	261	A34100B	262	AF38	257	AXI-11003	155
9A112	261	A34100S	262	AMT-15007	171	AXI-11004	155
9A114	261	A34100	257	AMT-15008	171	AXI-11005	155
9A12	261	A3412B	262	AMT-15010	171, 238	AXI-11006	155
9A1412	261	A3412S	262	AMT-15012	171, 238	AXI-110015	155
9A1438	261	A3412	257	AMT-15015	171, 238	AXI-110025	155
9A14	261	A3414	257	AMT-15018	171, 238	AXI-8002	155, 180
9A200	261	A3438B	262	AMT-15020	171, 238	AXI-8003	155, 180
9A300	261	A3438S	262	AMT-15023	171, 238	AXI-8004	155, 180
9A34	261	A3438	257	APM-BLACK	165	AXI-8005	155, 180
9A3812	261	A3458B	262	APM-BLUE	165	AXI-8006	155, 180
9A38	261	A3458S	262	APM-GRAY	165	AXI-80015	155, 180
A100114	257	A3458	257	APM-GREEN	165	B100	260
A10034	257	A34B	262	APM-ORANGE	165	B12	227, 260
A100B	262	A34S	262	APM-RED	165	B301AB	251
A100S	262	A34	257	APM-YELLOW	165	B33B	263
A100	257	A3812B	262	ASG1604	251	B3412	260
A112114	257	A3812S	262	ASG160	251	B34B	263
A112	257	A3812	257	ASG4004	251	B34	260
A114100	257	A3814B	262	ASG400	251	B35S	262
A114112	257	A3814S	262	ASG604	251	B35	260
A11434	257	A3814	257	ASG60	251	B-100SS	254
A114	257	A38516	257	ATR-BLACK	177	B-150SS	254
A12100	257	A3858	257	ATR-BLUE	177	B-200SS	254
A1214B	262	A38B	262	ATR-BROWN	177	B-300SS	254
A1214S	262	A38S	262	ATR-GRAY	177	B-750SS	254
A1214	257	A38	257	ATR-GREEN	177	BC100R	228
A12316	257	A-100SS	254	ATR-LILAC	177	BC100	228
A1234B	262	A-150SS	254	ATR-ORANGE	177	BC114	228

# Index

Part Number	Page	Part Number	Page	Part Number	Page	Part Number	Page
BC34R	228	CA9203P-S	127	CAP09-20	201	DP-200SS	255
BG-2910-0026	224	CA9303C-HM4C	127	CAP10-20	201	DP-300SS	255
BG-3430-0790	224	CA9303P-HM4C	127	CAP30-20	163, 200, 201	DP-750SS	255
BG-400275N	228	CA9910-D115	127	CPV007	228	E3412B	263
BG-4200-0060	201	CA9910-D30	127	CRC-13	175	E3412	259, 260
BG-4200-0061	201	CA9910-D30GRGI	127	CRC-23	175	E3438	259
BG-4200-0062	201	CA9910-D70	127	CRC-31	181	E34B	263
BG-4200-0063	201	CA9910-KIT1640	127	CRC-35	181	E34	259, 260
BG-4247N-B111	223	CAP00-01	149, 159, 184, 199, 201	CRC-45	175	E80-015	184, 199
BG-4247N-B119	223			CRC-46	175	E80-01	184, 199
BG-4247N-B121	223	CAP00-02	147, 149, 159, 184, 186, 199, 201	CRC-56	181	E80-02	184, 199
BG-4247N-B129	223			CS301AF0.4-65	198	E80-03	184, 199
BG-4247N-C111	223	CAP00-03	147, 149, 159, 184, 186, 199, 201	CS301AF0.7-80	198	E80-04	184
BG-4247N-C119	223			CS301AF1.2-105C	198	E80-05	184
BG-4247N-C121	223	CAP00-04	147, 149, 159, 184, 186, 201	CS301AF1.6-100	198	E80-06	184
BG-4247N-C129	223	CAP00-05	147, 159, 184, 201	CS301AFD0.7-80	198	E80-08	184
BG-7433-2502	224	CAP00-06	147, 159, 184, 201	CS301AFD1.2-105	198	E-100SS	255
BG-7433-2503	224	CAP00-08	147, 159, 184, 201	CS301MNF-W	198	E-150SS	255
BG-7433-2515	224	CAP00-10	159, 201	D252GRGI-25	83	E-200SS	255
BG-7433-2601	224	CAP00-015	147, 149, 159, 184, 199, 201	D252GRGI-55	83	E-300SS	255
BG-7433-2608	224			D30GRGI-65	84	E-750SS	255
BG-7433-2610	224	CAP00-15	159, 201	D30HRGI	78, 84	EL10012	257
BG-7433-2613	224	CAP00-20	159, 185, 201	D30HRGI-65	84	EL10034	257
BG-7433-3314	224	CAP00-025	147, 201	D30HRGI-65E	84	EL100HB	258
BG-7433-3316	224	CAP00-035	201	D34100	259	EL100	257
BG-UFC0100E-A-S	252	CAP01-01	139, 179, 201	D3412B	263	EL112HB	258
BG-UFC0150E-A-S	252	CAP01-02	139, 179, 187, 201	D3412	259	EL112	257
BG-UFC0200E-A-S	252	CAP01-03	139, 179, 187, 201	D3414	259	EL114100	257
BG-UFC0300E-A-S	252	CAP01-04	139, 179, 187, 201	D3438B	263	EL114112	257
C100	260	CAP01-05	139, 201	D3438	259	EL11434	257
C12B	263	CAP01-06	201	D3458B	263	EL114HB	258
C12NPT	260	CAP01-08	201	D3458	259	EL114	257
C12S	262	CAP01-10	201	D34B	263	EL12100	257
C12	260	CAP01-015	139, 179, 187, 201	D34	259	EL1214HB	258
C14	260	CAP01-15	201	D403GRGI-65	84	EL1214	257
C34B	263	CAP01-20	201	D403HRGI	84	EL1234F	257
C34S	262	CAP01-025	179, 187, 201	D403HRGI-65	84	EL1234	257
C34	260	CAP04-01	201	D403HRGI-65E	84	EL1238HB	258
C38B	263	CAP04-02	182, 201	D503HRGI	85	EL1238	257
C38	260	CAP04-03	182, 201	D503HRGI-65	85	EL1258F	257
C58B	263	CAP04-04	182, 201	D503HRGI-65E	85	EL1258	257
C58	260	CAP04-05	182, 201	D-100SS	255	EL12HB	258
C-100SS	254	CAP04-06	182, 201	D-150SS	255	EL12	257
C-150SS	254	CAP04-08	201	D-200SS	255	EL1412	257
C-200SS	254	CAP04-10	201	D-300SS	255	EL1438F	257
C-300SS	254	CAP04-015	201	D-750SS	255	EL1438	257
C-750SS	254	CAP04-15	201	DC-100SS	255	EL14516	257
CA5210C	127	CAP04-20	165, 176, 201	DC-150SS	255	EL1458	257
CA5320C-HRX	127	CAP04-025	201	DC-200SS	255	EL14F	257
CA5321C-H	127	CAP05-01	201	DC-300SS	255	EL14HB	258
CA5324C	127	CAP05-02	201	DC-750SS	255	EL14	257
CA6500C	127	CAP05-03	201	DCC-01	175, 181	EL1814	257
CA6500N	127	CAP05-04	201	DCC-02	175, 181	EL18316	257
CA6500XL	127	CAP05-05	201	DCC-03	175, 181	EL1838	257
CA7560C	127	CAP05-06	201	DCC-04	175, 181	EL18516	257
CA7560N	127	CAP05-08	201	DCC-05	175, 181	EL200HB	258
CA7560XL	127	CAP05-015	201	DCC-06	175, 181	EL200	257
CA9006C-O	127	CAP05-20	175, 177, 178, 181, 201	DCC-07	175, 181	EL34100	257
CA9006P-O	127			DP-100SS	255	EL3412F	257
CA9202C	127	CAP05-025	201	DP-150SS	255	EL3412	257

# Index

Part Number	Page	Part Number	Page	Part Number	Page	Part Number	Page
EL3414	257	F80-04	159	FC-GA110-03	141	FNAE-112100	254
EL3438	257	F80-05	159	FC-GA110-04	141	FNAE-112112	254
EL3458F	257	F80-06	159	FC-GA110-05	141	FNAE-112114	254
EL3458HB	258	F80-08	159	FC-GA110-015	141	FNAE-114100	254
EL3458	257	F80-10	159	FC-GA110-025	141	FNAE-114114	254
EL34F	257	F80-15	159	FC-GA110-035	141	FNAE-200200	254
EL34HB	258	F80-20	159	FC-TR110-01	153	FNAE-3412	254
EL34	257	F-100SS	255	FC-TR110-02	153	FNAE-3434	254
EL3812F	257	F-150SS	255	FC-TR110-03	153	FNAE-3458	254
EL3812	257	F-200SS	255	FC-TR110-04	153	FNAS-10012	254
EL3814F	257	F-300SS	255	FC-TR110-05	153	FNAS-10034	254
EL3814HB	258	F-750SS	255	FC-TR110-06	153	FNAS-100100	254
EL3814	257	FC100	258	FC-TR110-08	153	FNAS-1212	254
EL38516	257	FC112	258	FC-TR110-10	153	FNAS-112100	254
EL3858	257	FC114	258	FC-TR110-15	153	FNAS-112112	254
EL38F	257	FC12B	263	FC-TR110-015	153	FNAS-112114	254
EL38HB	258	FC12	258	FC-TR80-01	153	FNAS-114100	254
EL38	257	FC14B	263	FC-TR80-015	153	FNAS-114114	254
EL58HB	258	FC200	258	FC-TR80-02	153	FNAS-200200	254
ELD3412	259	FC34	258	FC-TR80-03	153	FNAS-3412	254
ELD3414	259	FC-AVI-110025	143	FC-TR80-04	153	FNAS-3434	254
ELD3438	259	FC-AVI-110015	143	FC-TR80-05	153	FNAS-3458	254
ELD3458	259	FC-AVI-11010	143	FC-TR80-06	153	FNCAP-100	254
ELD34	259	FC-AVI-11008	143	FC-TR80-08	153	FNCAP-100N	124
ESI-11002	167	FC-AVI-11006	143	FC-TR80-10	153	FNE-10034	124
ESI-11003	167	FC-AVI-11005	143	FC-TR80-15	153	FNE-100100	124
ESI-11004	167	FC-AVI-11004	143	FC-ULD120-015	135	FNS-10012	124
ESI-11005	167	FC-AVI-11003	143	FC-ULD120-02	135	FNS-10034	124
ESI-11006	167	FC-AVI-11002	143	FC-ULD120-025	135	FNS-100100	124
ESI-110015	167	FC-AVI-11001	143	FC-ULD120-03	135	G3412	259
ESI-110025	167	FC-AXI-110015	155	FC-ULD120-04	135	G3414	259
F100	258	FC-AXI-80015	155, 180	FC-ULD120-05	135	G34	259
F110-01	159	FC-AXI-11006	155	FC-ULD120-06	135	G40004	233
F110-02	159	FC-AXI-11005	155	FC-ULD120-08	135	GA110-02	141
F110-03	159	FC-AXI-11004	155	FC-VP110-02	151	GA110-03	141
F110-04	159	FC-AXI-11003	155	FC-VP110-03	151	GA110-04	141
F110-05	159	FC-AXI-11002	155	FC-VP110-04	151	GA110-05	141
F110-06	159	FC-AXI-8006	155, 180	FC-VP110-05	151	GA110-015	141
F110-08	159	FC-AXI-8005	155, 180	FC-VP110-06	151	GA110-025	141
F110-015	159	FC-AXI-8004	155, 180	FC-VP110-08	151	GA110-035	141
F110-10	159	FC-AXI-8003	155, 180	FC-VP110-10	151	GAT110-035	137
F110-15	159	FC-AXI-8002	155, 180	FC-VP110-15	151	GAT110-025	137
F110-20	159	FC-ESI-110025	167	FC-VP110-015	151	GAT110-08	137
F112	258	FC-ESI-110015	167	FC-VP110-025	151	GAT110-06	137
F114	258	FC-ESI-11015	167	FC-VP110-035	151	GAT110-05	137
F12B	263	FC-ESI-11010	167	FC-VP80-015	151	GAT110-04	137
F12	258	FC-ESI-11008	167	FC-VP80-02	151	GAT110-03	137
F14B	263	FC-ESI-11006	167	FC-VP80-03	151	GAT110-02	137
F14	258	FC-ESI-11005	167	FC-VP80-04	151	GAT110-025A	137
F18	258	FC-ESI-11004	167	FC-VP80-05	151	GAT110-02A	137
F200	258	FC-ESI-11003	167	FC-VP80-06	151	GAT110-035A	137
F34	258	FC-ESI-11002	167	FC-XT010	189	GAT110-03A	137
F38B	263	FC-ESI-110015P	167	FC-XT015	189	GAT110-04A	137
F38	258	FC-ESI-11002P	167	FC-XT020	189	GAT110-05A	137
F65-005	197	FC-ESI-11003P	167	FC-XT024	189	GAT110-06A	137
F80-0067	159, 197	FC-ESI-11004P	167	FC-XT043	189	GAT110-08A	137
F80-015	159	FC-ESI-11005P	167	FM-1100	103	GG10000	250
F80-01	159	FC-ESI-11006P	167	FM-1100i	103	GG1000	250
F80-02	159	FC-ESI-11020P	167	FNAE-10034	254	GG1004	250
F80-03	159	FC-GA110-02	141	FNAE-100100	254	GG100	250

# Index

Part Number	Page	Part Number	Page	Part Number	Page	Part Number	Page
GG15000	250	J3412	259	NF1614	227	RB3814	258
GG1500	250	K8412	227	NS12	264	RB3818	258
GG160	250	K8414	227	NS17	264	RI167	249
GG2000	250	K8438	227	NS21	264	RW1116A	260
GG200	250	LA24	248	NS28	264	RW1116B	260
GG3000	250	LA5	248	NS32	264	RW1116C	260
GG300	250	LD110-02	147	NS4	264	RW1116D	260
GG30	250	LD110-03	147	NS7	264	SA12B	263
GG4000	250	LD110-04	147	NS8	264	SA38B	263
GG400	250	LD110-05	147	NTL12	227	SE100	257
GG5000	250	LD110-06	147	NTL14	227	SE112	257
GG6000	250	LD110-08	147	NTL34	227	SE114	257
GG600	250	LD110-015	147	NTL38	227	SE12B	262
GG604	250	LD110-025	147	NTL58	227	SE12	257
GG60	250	LD80-02	147	NTT12	227	SE1445	258
GRD120-025	145	LD80-03	147	NTT34	227	SE14B	262
GRD120-015	145	LD80-04	147	NTT38	227	SE14	257
GRD120-08	145	LD80-05	147	NTT58	227	SE200	257
GRD120-06	145	LD80-06	147	OCI-8002	186	SE3445	258
GRD120-05	145	LD80-08	147	OCI-8003	186	SE34	257
GRD120-04	145	LD80-015	147	OCI-8004	186	SE38B	262
GRD120-03	145	LL100	258	PC1/2F-235120	232	SE38	257
GRD120-02	145	LL112	258	PC1/2F-36075	232	SF-1100	103
GRD120-01	145	LL114	258	PC1/2F-36075-PV	232	SF-1105	103
GTT1214	258	LL12	258	PK-4223N-B524PSE	216	SF-1100-110V	103
GTT3414	258	LL14B	263	PP301AF0.4-65	198	SF-1100-PTS	102
H34	259	LL18B	263	PP301AF0.7-80	198	SF-1100-PTSi	102
HF140-08	161	LL200	258	PP301AF0.7-80W	198	SF-1100-PTSi-00	102
HF140-10	161	LL34	258	PP301AF1.2-105C	198	SF-1100-REC-DT	102
HF140-15	161	LT2	264	PP301AF1.6-100	198	SF-1105-PTS	102
HF140-20	161	LT4	264	PS3/4F-PN	225	SF-1105-PTSi	102
HF140-30	161	M100	258	PV1/2F1/2M-MA	232	SF-1105-REC	102
HF140-40	161	M112	258	Q12	260	SG1000	250
HF140-50	161	M114	258	Q14	260	SG1001.58C	250
HF140-60	161	M1214	258	QT14-1-NDC	223	SG1002C	250
HM1214	259	M1218	258	RB10012	258	SG1002	250
HM1238	259	M1238	258	RB10034	258	SG1004	250
HM14316	259	M12	258	RB112100	258	SG100	250
HM14	259	M1418	258	RB112114	258	SG152	250
HM18	259	M14	258	RB112134	258	SG15	250
HM3814	259	M18	258	RB114100	258	SG1601.58C	250
HM516	259	M200	258	RB11434	258	SG1602C	250
HM5838	259	M3412	258	RB1214B	263	SG1602	250
HM58	259	M3438	258	RB1214	258	SG160	250
HP1/4-00xx	193	M34	258	RB1218	258	SG2000	250
HP1/4-05xx	193	M3814	258	RB1238B	263	SG2001.58C	250
HP1/4-15xx	193	M3818	258	RB1238	258	SG2002C	250
HP1/4-25xx	193	M38	258	RB1418B	263	SG2002	250
HP1/4-40xx	193	MF1814B	251	RB200100	258	SG2004	250
HP1/8-00xx	193	N34	260	RB200112	258	SG200	250
HP1/8-05xx	193	NB1612	227	RB200114	258	SG3000	250
HP1/8-15xx	193	NB1614	227	RB20034	258	SG3002C	250
HP1/8-25xx	193	NBC10	227	RB212200	258	SG3002	250
HP1/8-40xx	193	NC1214	260	RB300200	258	SG300	250
HPDS5000	194	NC12N	260	RB3412B	263	SG302	250
HPDSQ20WB	194	NC12	260	RB3412	258	SG30	250
HPPDQ4000	194	NC14N	260	RB3414	258	SG400	250
HPWWHVUC	194	NC14	260	RB3418	258	SG5000	250
HPWWHV	194	NC38N	260	RB3438	258	SG600	250
I34	260	NC38	260			SG601.58C	250



# Index

Part Number	Page	Part Number	Page	Part Number	Page	Part Number	Page
SG602C	250	TL08-0001	230	TT200	258	UF300X	253
SG602	250	TL08-0002	230	TT34	258	UF300	252
SG604	250	TL08-0003	230	TUR324B-x.x	191	UFC0100-S	252
SG60	250	TL08-0011	230	TUR324B-x.x-BSP	191	UFC0150-S	252
SHM100	259	TL08-0012	230	TUR324S-x.x	191	UFC0200-S	252
SHM112	259	TL08-0013	230	TUR330B-x.x	191	UFC0300-S	252
SHM114	259	TL08-0014	230	TUR330S-x.x	191	UFG0100E-A	224, 252
SHM1238	259	TL12-0001	230	TVI-8002	178	UFG0150E-A	252
SHM1258	259	TL12-0002	230	TVI-8003	178	UFG0200E-A	252
SHM12B	262	TL12-0003	230	TVI-80005	178	UFG0300E-A	252
SHM12	259	TL12-0006	230	TVI-80015	178	ULD120-025	135
SHM14B	262	TL12-0007	230	TVI-80025	178	ULD120-015	135
SHM14	259	TL12-0011	230	TVI-800075	178	ULD120-08	135
SHM200	259	TL12-0012	230	UAS1/4-00-xx	192	ULD120-06	135
SHM34B	262	TL12-0013	230	UAS1/4-15-xx	192	ULD120-05	135
SHM34	259	TL12-0014	230	UAS1/4-25-xx	192	ULD120-04	135
SHM38B	262	TL16-0001	230	UAS1/4-40-xx	192	ULD120-03	135
SHM38	259	TL16-0002	230	UASPDQ4000	194	ULD120-02	135
SHM58B	262	TL16-0003	230	UASWWHV	194	VGG30160	250
SHM58	259	TL16-0006	230	UASWWHVUC	194	VGG3030	250
SLV10-AA40	99	TL16-0007	230	UF100-FN025P	253	VGG3060	250
SLV10-AA41	99	TL16-0011	230	UF100-FN100	253	VGG30604	250
SLV10-AA48	99	TL16-0012	230	UF100-HB075	253	VGG30	250
SLV10-AB41	99	TL16-0013	230	UF100-HB100	253	VP110-02	151
SLV10-HA01	99	TL16-0014	230	UF100-HB125	253	VP110-03	151
T100	259	TLP-0007	230	UF100-HBT100	253	VP110-04	151
T112	259	TLP-0018	230	UF100-MN075	253	VP110-05	151
T114	259	TLP-0023	230	UF100-MN100	253	VP110-06	151
T1234T	259	TLP-0046	231	UF100-MN125	253	VP110-08	151
T1238T	259	TLP-0050	231	UF100L-HB075	253	VP110-10	151
T1238	259	TR110-01	153	UF100L-HB100	253	VP110-015	151
T1258T	259	TR110-02	153	UF100L-HB125	253	VP110-15	151
T12C	227	TR110-03	153	UF100L	252	VP110-025	151
T12T	259	TR110-04	153	UF100P	253	VP110-035	151
T12	259	TR110-05	153	UF100T	252	VP80-02	151
T1412T	259	TR110-06	153	UF100X	253	VP80-03	151
T1438T	259	TR110-08	153	UF100	252	VP80-04	151
T1438	259	TR110-10	153	UF200-FN200	253	VP80-05	151
T14T	259	TR110-015	153	UF200-HB150	253	VP80-06	151
T14	259	TR110-15	153	UF200-HB200	253	VP80-015	151
T1814T	259	TR80-01	153	UF200-MA200	253	VPT110-035	157
T18	259	TR80-02	153	UF200-MN200	253	VPT110-025	157
T200	259	TR80-03	153	UF200-RC100	253	VPT110-06	157
T34100T	259	TR80-04	153	UF200L-HB150	253	VPT110-05	157
T3412T	259	TR80-05	153	UF200L-HB200	253	VPT110-04	157
T3412	259	TR80-06	153	UF200L	252	VPT110-03	157
T34C	227	TR80-08	153	UF200P	253	VPT110-02	157
T34F	259	TR80-015	153	UF200T	252	VPT80-02	157
T34T	259	TR80-10	153	UF200X	253	VPT80-03	157
T34	259	TR80-15	153	UF200	252	VPT80-04	157
T3812T	101, 259	TS01-100	135, 202	UF300-HB200	253	VPT80-05	157
T3812	259	TS01-50	135, 202	UF300-HB300	253	VPT80-06	157
T3814T	259	TS02-100	145, 202	UF300-MA300	253	VPTCAP	157, 202
T3858	259	TS02-50	137, 145, 202	UF300-MN300	253	W160M	260
T38C	227	TS03-25	202	UF300-RC200	253	W405P	260
T38T	259	TT100	258	UF300L-HB200	253	W406V	260
T38	259	TT112	258	UF300L-HB300	253	WBH100GAS	233
T58	259	TT114	258	UF300L	252	WBH100	233
TL06-0003	229	TT12	258	UF300P	253	WBH112	233
TL06-0004	229	TT14	258	UF300T	252	WBH114/112GAS	233

# Index

Part Number	Page	Part Number	Page	Part Number	Page	Part Number	Page
WBH114	233	WGG2000C	250	WGGSS100C	251	XT024	189
WBH12/34GAS	233	WGG200C	250	WGGSS3000	251	XT043-GIOKIT	189
WBH12	233	WGG3000C	250	WGGSS400	251	XT043	189
WBH200GAS	233	WGG300C	250	WGGSS400C	251	XT080-GIOKIT	189
WBH200	233	WGG400C	250	WGGSS5000	251	XT080	189
WBH300	233	WGG5000C	250	WGGSS60	251	XT167-GIOKIT	189
WBH34	233	WGG6000C	250	WGGSS600	251	XT167	189
WBH400	233	WGG600C	250	XT010-GIOKIT	189	XT215-GIOKIT	189
WGG1000C	250	WGG60C	250	XT010	189	XT215	189
WGG100C	250	WGGSS100	251	XT020-GIOKIT	189	Y01356040	231
WGG1500C	250	WGGSS1000	251	XT020	189	Y01356061	231
WGG160C	250	WGGSS160	251	XT024-GIOKIT	189		

# Limited Warranty on HYPRO/SHURFLO Agricultural Pumps & Accessories

---

Hypro/SHURflo (hereafter, "Hypro") agricultural products are warranted to be free of defects in material and workmanship under normal use for the time periods listed below, with proof of purchase.

- Pumps: one (1) year from the date of manufacture, or one (1) year of use. This limited warranty will not exceed two (2) years, in any event.
- Accessories: ninety (90) days of use.

This limited warranty will not apply to products that were improperly installed, misapplied, damaged, altered, or incompatible with fluids or components not manufactured by Hypro. All warranty considerations are governed by Hypro's written return policy.

Hypro's obligation under this limited warranty policy is limited to the repair or replacement of the product. All returns will be tested per Hypro's factory criteria. Products found not defective (under the terms of this limited warranty) are subject to charges paid by the returnee for the testing and packaging of "tested good" non-warranty returns.

No credit or labor allowances will be given for products returned as defective. Warranty replacement will be shipped on a freight allowed basis. Hypro reserves the right to choose the method of transportation.

This limited warranty is in lieu of all other warranties, expressed or implied, and no other person is authorized to give any other warranty or assume obligation or liability on Hypro's behalf. Hypro shall not be liable for any labor, damage or other expense, nor shall Hypro be liable for any indirect, incidental or consequential damages of any kind incurred by the reason of the use or sale of any defective product.

## Return Procedures

All products must be flushed of any chemical (ref. OSHA section 1910.1200 (d) (e) (f) (g) (h)) and hazardous chemicals must be labeled/tagged before being shipped\* to Hypro for service or warranty consideration. Hypro reserves the right to request a Material Safety Data Sheet from the returnee for any pump/product it deems necessary. Hypro reserves the right to "disposition as scrap" products returned which contain unknown fluids. Hypro reserves the right to charge the returnee for any and all costs incurred for chemical testing, and proper disposal of components containing unknown fluids. Hypro requests this in order to protect the environment and personnel from the hazards of handling unknown fluids.

Be prepared to give Hypro full details of the problem, including the model number, date of purchase, and from whom you purchased your product. Hypro may request additional information, and may require a sketch to illustrate the problem.

Contact the appropriate Hypro Service Department to receive a Return Merchandise Authorization number (RMA#). Returns are to be shipped with the RMA number clearly marked on the outside of the package. Hypro shall not be liable for freight damage incurred during shipping. Please package all returns carefully. All products returned for warranty work should be sent shipping charges prepaid:

### US/Canada

HYPRO / PENTAIR  
Attention: Service Department  
375 Fifth Avenue NW  
New Brighton, MN 55112  
Service: 800-468-3428  
Fax: 651-766-6618  
Technical: 800-445-8360  
hypro.technical@pentair.com

### Europe

HYPRO EU Ltd.  
Station Road  
Longstanton  
Cambridge CB24 3DS UK  
Service/Technical:  
+44 1954 260097  
Fax: +44 1954 260245  
euagorders@pentair.com

### South America & Central America

Pentair Water do Brasil LTDA  
Av. Marginal Norte da Via  
Ananguera, 53.700  
Jundiai/SP - Brasil  
CEP 13206-245  
Tel: (11) 3378-5400  
vendas.pwdb@pentair.com

### All Other Regions

HYPRO / PENTAIR  
Attention: Service Department  
375 Fifth Avenue NW  
New Brighton, MN 55112  
Service: 800-468-3428  
Fax: 651-766-6618  
Technical: 800-445-8360  
hypro.technical@pentair.com

\*Carriers, including U.S.P.S., airlines, UPS, ground freight, etc., require specific identification of any hazardous material being shipped. Failure to do so may result in a substantial fine and/or prison term. Check with your shipping company for specific instructions.



Hypro LLC, 375 Fifth Avenue NW, New Brighton, MN 55112, USA  
Tel: 651-766-6300 Fax: 651-766-6600 E-mail: [hypro.sales@pentair.com](mailto:hypro.sales@pentair.com) Online: [www.hypropumps.com](http://www.hypropumps.com)

Technical: 800-445-8360 Order Department: 800-42-HYPRO (800-424-9776) FAX for fast delivery: 800-323-6496

Europe: Hypro EU LTD. Station Road, Longstanton, Cambridge CB24 3DS, UK  
Tel: +44 1954 260097 Fax: +44 1954 260245  
E-mail: [euaginfo@pentair.com](mailto:euaginfo@pentair.com) Order E-mail: [euagorders@pentair.com](mailto:euagorders@pentair.com) Online: [www.hypro-eu.com](http://www.hypro-eu.com)

Central & South America:  
Pentair Water do Brasil LTDA Av. Marginal Norte da Via Anhanguera, 53.700 Jundiaí/SP - Brasil CEP 13206-245  
Tel: (11) 3378-5400 E-mail: [vendas.pwdb@pentair.com](mailto:vendas.pwdb@pentair.com)